

**15000W Axial Leaded Transient Voltage Suppressors**

**P<sub>PP</sub> 15000W**

**V<sub>RWM</sub> 17V~280V**

**FEATURES**

- ◆Peak power dissipation 15000w @10 x 1000 us Pulse
- ◆Low profile package.
- ◆Excellent clamping capability.
- ◆Glass passivated junction.
- ◆Fast response time: typically less than 1ps from 0 volts to BV min
- ◆Typical I<sub>R</sub> less than 2uA when VBR min above 36V.
- ◆IEC 61000-4-2 ESD 30kv(air), 30kv(contact)
- ◆ESD protection of data lines in accordance with IEC 61000-4-2
- ◆EFT protection of data lines in accordance with IEC 61000 4-4
- ◆Halogen free and ROHS compliant
- ◆Lead-free finish

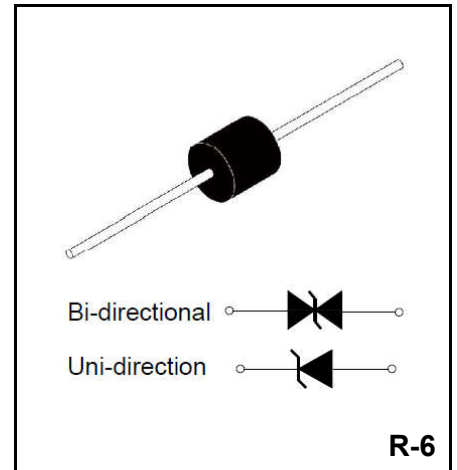

**MECHANICAL CHARACTERISTICS**

- ◆Case: R-6 Molded Plastic
- ◆Mounting Position: Any
- ◆Polarity: by cathode band denotes UNI-directional device, none cathode band denotes bi-directional device.
- ◆Terminal: Solder plated

**Maximum Ratings and Characteristics @ 25°C Ambient Temperature (unless otherwise noted)**

Parameter	Symbol	Value	Unit
Peak Pulse Power Dissipation on 10/1000 us Waveform (Note 1, FIG.1)	<b>P<sub>PPM</sub></b>	15000	<b>W</b>
Peak Forward Surge Current, 8.3ms Single Half Sine-Wave (Note 2)	<b>I<sub>FSM</sub></b>	400	<b>A</b>
Peak Pulse Current of on 10/1000us Waveform (Note 1, FIG.3)	<b>I<sub>PPM</sub></b>	See Next Table	<b>A</b>
Power Dissipation on Infinite Heat Sink at T <sub>L</sub> =75°C	<b>P<sub>D</sub></b>	8.0	<b>W</b>
Operating junction and storage Temperature range	<b>T<sub>J</sub>,T<sub>STG</sub></b>	-55 to +150	<b>°C</b>

Notes:

1. Non-repetitive current pulse, per Fig.3 and derated above T<sub>A</sub>=25°C per Fig.2.
2. Measured on 8.3ms single half sine-wave, or equivalent square wave, for Unidirectional device only.

**Electrical Specification ( $T_A=25@25^{\circ}\text{C}$  unless otherwise specified)**

Type Number		Reverse Stand-Off Voltage	Breakdown Voltage Min. @ $I_T$	Breakdown Voltage Max. @ $I_T$	Test Current	Maximum Clamping Voltage @ $I_{PP}$	Peak Pulse Current	Reverse Leakage @ $V_{RMW}$
(Uni)	(Bi)	$V_{RMW}(V)$	$V_{BR\ MIN}(V)$	$V_{BR\ MAX}(V)$	$I_T\ (mA)$	$V_C(V)$	$I_{PP}(A)$	$I_R(\mu A)$
15KP17A	15KP17CA	17	18.99	20.79	50	29.3	515.4	5000
15KP18A	15KP18CA	18	20.11	22.01	50	30.9	488.7	5000
15KP20A	15KP20CA	20	22.34	24.46	20	34.3	440.2	1500
15KP22A	15KP22CA	22	24.57	26.91	10	37.1	407.0	500
15KP24A	15KP24CA	24	26.81	29.35	5	40.7	371.0	150
15KP26A	15KP26CA	26	29.04	31.80	5	44.0	343.2	50
15KP28A	15KP28CA	28	31.28	34.24	5	47.5	317.9	25
15KP30A	15KP30CA	30	33.51	36.70	5	50.7	297.8	15
15KP33A	15KP33CA	33	36.90	40.40	5	54.7	276.1	2
15KP36A	15KP36CA	36	40.20	44.00	5	59.8	252.5	2
15KP40A	15KP40CA	40	44.70	48.90	5	65.8	229.5	2
15KP43A	15KP43CA	43	48.00	52.60	5	69.8	216.3	2
15KP45A	15KP45CA	45	50.30	55.00	5	72.8	207.4	2
15KP48A	15KP48CA	48	53.60	58.70	5	77.7	194.3	2
15KP51A	15KP51CA	51	57.00	62.40	5	82.9	182.1	2
15KP54A	15KP54CA	54	60.30	66.00	5	87.7	172.2	2
15KP58A	15KP58CA	58	64.80	70.90	5	93.8	161.0	2
15KP60A	15KP60CA	60	67.00	73.40	5	97.4	155.0	2
15KP64A	15KP64CA	64	71.50	78.30	5	104.2	144.9	2
15KP70A	15KP70CA	70	78.20	85.60	5	113.6	132.9	2
15KP75A	15KP75CA	75	83.80	91.70	5	122.0	123.8	2
15KP78A	15KP78CA	78	87.10	95.40	5	126.1	119.7	2
15KP85A	15KP85CA	85	94.90	104.00	5	137.6	109.7	2
15KP90A	15KP90CA	90	100.50	110.10	5	145.6	103.7	2
15KP100A	15KP100CA	100	111.70	122.30	5	161.3	93.6	2
15KP110A	15KP110CA	110	122.90	134.50	5	178.6	84.5	2
15KP120A	15KP120CA	120	134.00	146.80	5	192.3	78.5	2
15KP130A	15KP130CA	130	145.20	159.00	5	208.3	72.5	2
15KP150A	15KP150CA	150	167.60	183.50	5	241.9	62.4	2
15KP160A	15KP160CA	160	178.70	195.70	5	258.6	58.4	2
15KP170A	15KP170CA	170	189.90	207.90	5	272.7	55.4	2
15KP180A	15KP180CA	180	201.10	220.10	5	288.5	52.3	2
15KP200A	15KP200CA	200	223.40	244.60	5	319.1	47.3	2
15KP220A	15KP220CA	220	245.70	269.10	5	356.0	42.4	2
15KP240A	15KP240CA	240	268.10	293.50	5	384.6	39.3	2
15KP260A	15KP260CA	260	290.40	318.00	5	416.7	36.2	2
15KP280A	15KP280CA	280	312.80	342.40	5	454.5	33.2	2

※ For Bi-directional type having  $V_{RWM}$  of 30 Volts and less, the  $I_R$  limit is double.

※ For parts without A, the  $V_{BR}$  is  $\pm 10\%$  and  $V_C$  is 5% higher than with A parts.

**I-V Curve Characteristics**

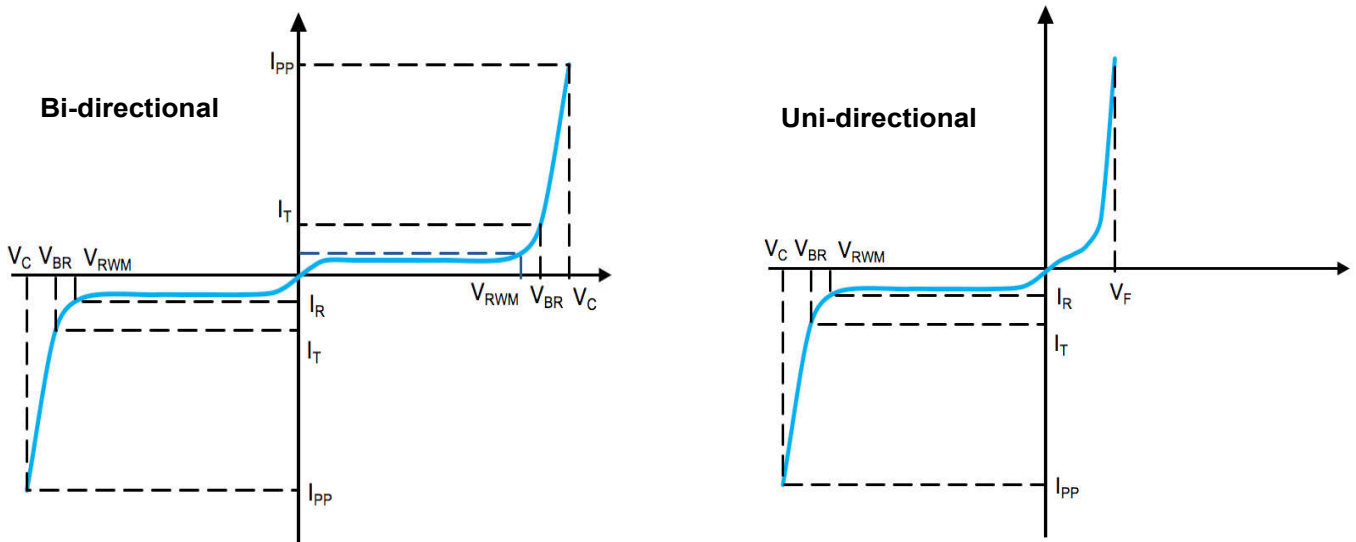

- $P_{PPM}$**  Peak Pulse Power Dissipation - Max power dissipation
- $V_{RWM}$**  Reverse Stand-off Voltage - Maximum voltage that can be applied to TVS without operation
- $V_{BR}$**  Breakdown Voltage – Maximum voltage that flows though the TVS at a specified current ( $I_T$ )
- $V_C$**  Clamping Voltage – Peak voltage measured across the TVS at a specified  $I_{PPM}$  (peak impulse current)
- $I_R$**  Reverse Leakage Current – Current measured at  $V_R$
- $V_F$**  Forward Voltage Drop for Uni-directional

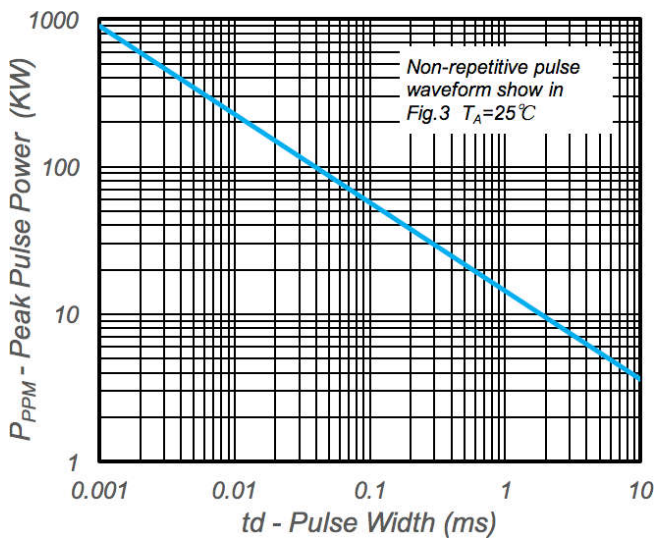

Fig.1 - Peak Pulse Power Rating

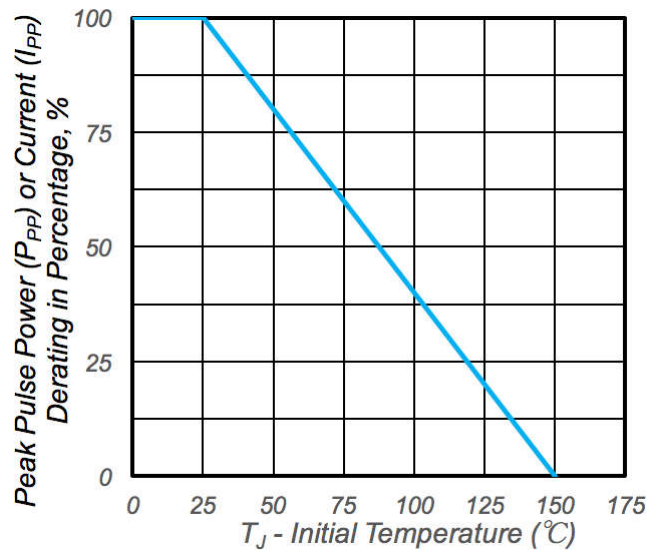

Fig.2 - Pulse Derating Curve

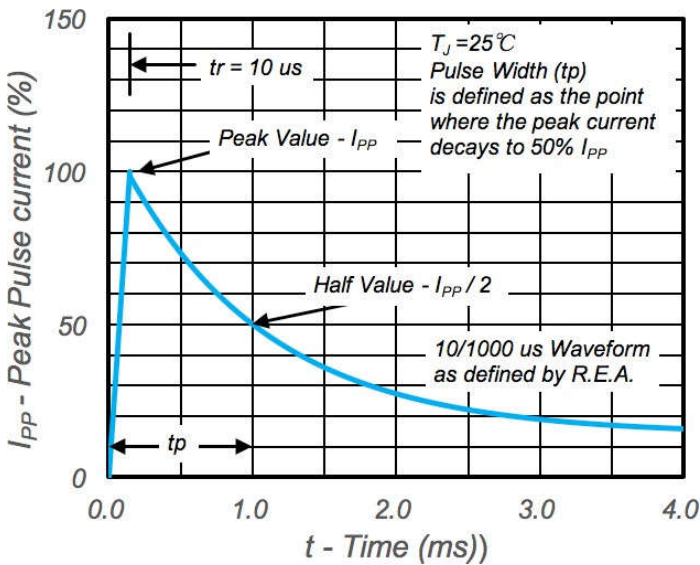

Fig.3 - Pulse Waveform

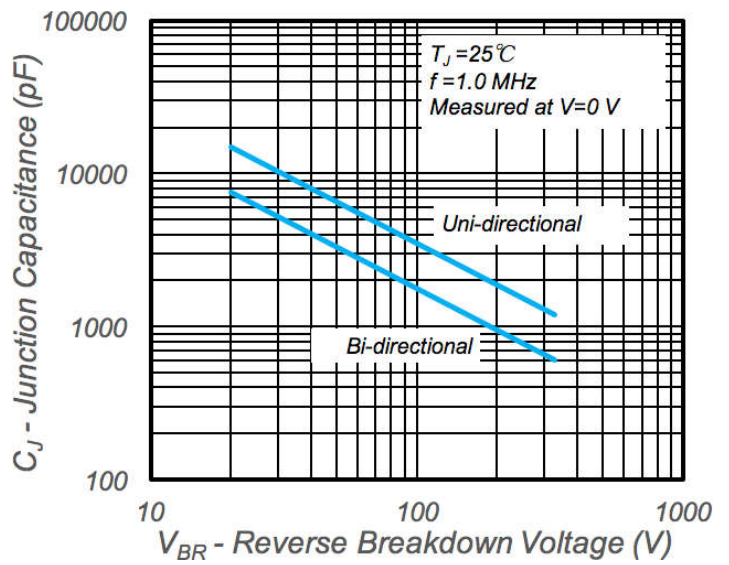
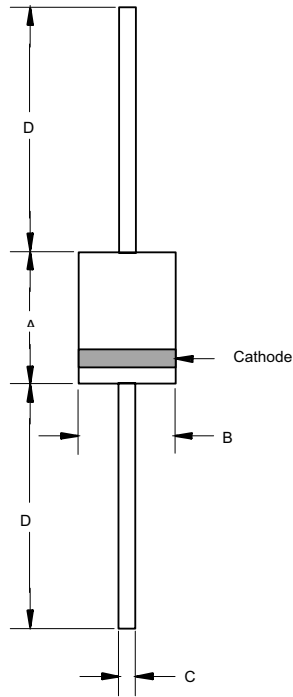

Fig.4 - Typical Junction Capacitance

Package Outline R-6



DIMENSIONS					
DIM	INCHES		MM		NOTE
	MIN	MAX	MIN	MAX	
A	.340	.360	8.60	9.10	
B	.340	.360	8.60	9.10	
C	.048	.052	1.20	1.30	
D	1.000	---	25.40	---	

Summary of Packing Options

Package	Packing Description	Packing Quantity	Industry Standard
R-6	BOX	300	EIA-481-1

单击下面可查看定价，库存，交付和生命周期等信息

[>>YFW\(佑风微\)](#)