

■ **Bidirectional ESD Protection Diodes**

■ **Features**

- Bidirectional ESD protection of one line.
- Max. peak pulse power : Ppp = 350W at tp = 8/20 us
- ESD protection >25 kV per MIL-STD-883C, Method 3015-6:Class3
- IEC 61000-4-2, level 4 (ESD), >15KV (air); >8KV (contact).

■ **Application**

- Computers and peripherals
- Communication system
- Notebooks. Desktops & Servers.
- Portable electronics
- Cellular handsets and accessories.

■ **General Description**

Electro Static Discharge (ESD) protection diodes in ultra small SMD Plastic packages designed to protect one signal line from the damage caused by ESD and other transients.

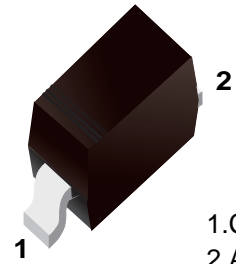

■ **Simplified outline(SOD-323)**

Top View

Marking Code	
ESD3Z12CA	WBC

■ **Absolute Maximum Ratings Ta = 25°C**

Parameter	Symbol	Value	Unit
Peak Pulse Power(tp=8/20us)	P _{PPM}	350	W
Peak Pulse Current(tp=8/20us)	I _{PP}	15	A
Operating Junction Temperature	T _J	-55 to +150	°C
Storage Temperature	T _{STG}	-55 to +150	°C

■ **Electrical Characteristics Ta = 25°C**

Parameter	Symbol	Conditions	Minimum	Typical	Maximum	Units
Reverse Stand-Off Voltage	V _{DRM}				12.0	V
Reverse Breakdown Voltage	V _{BR}	I _T =1mA	13.3		15.5	V
Reverse Leakage Current	I _R	V _{RWM} =12V,Ta=25°C			1.0	uA
Clamping Voltage	V _C	I _{PP} =15A,tp=8/20us			24	V
Junction Capacitance	C _J	V _R =0V,f=1HMz			100	pF

Fig.1 Non-Repetitive Peak Pulse Power vs. Pulse Time

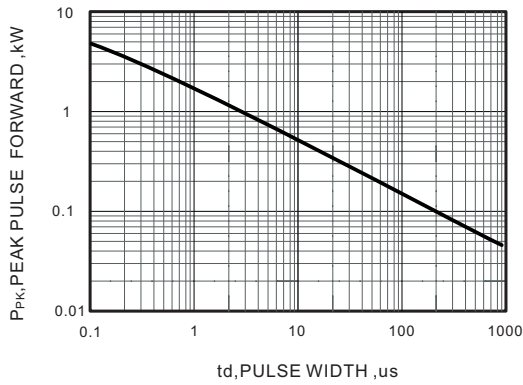

Fig.2 Forward Current Derating Curve

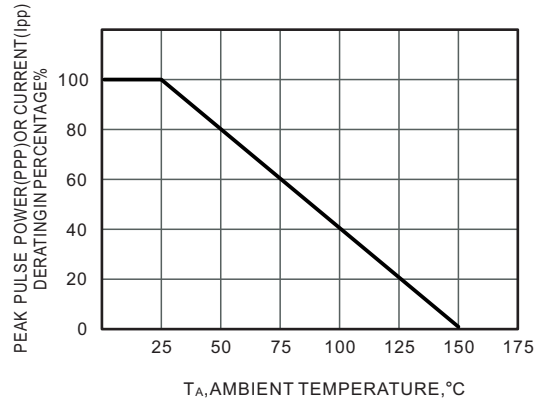

Fig.3 Waveform

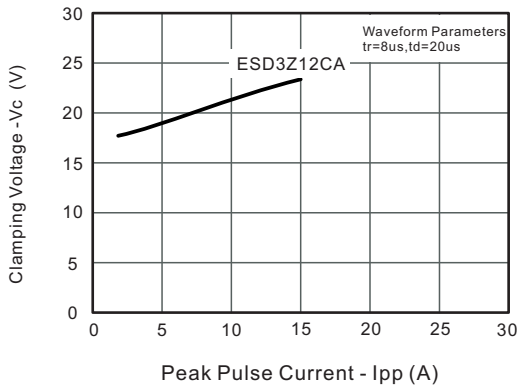

Fig.4 Power Derating Curve

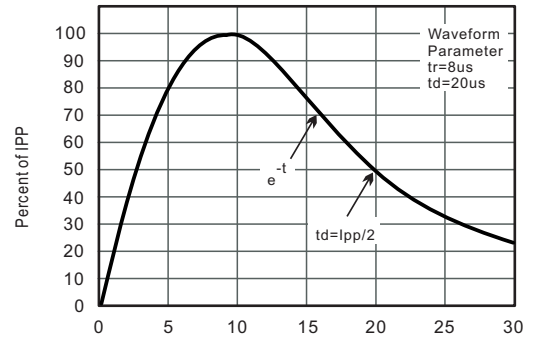
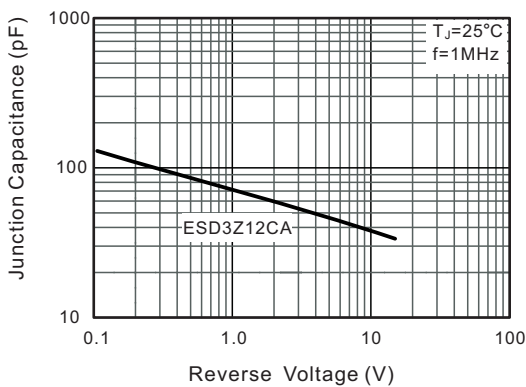
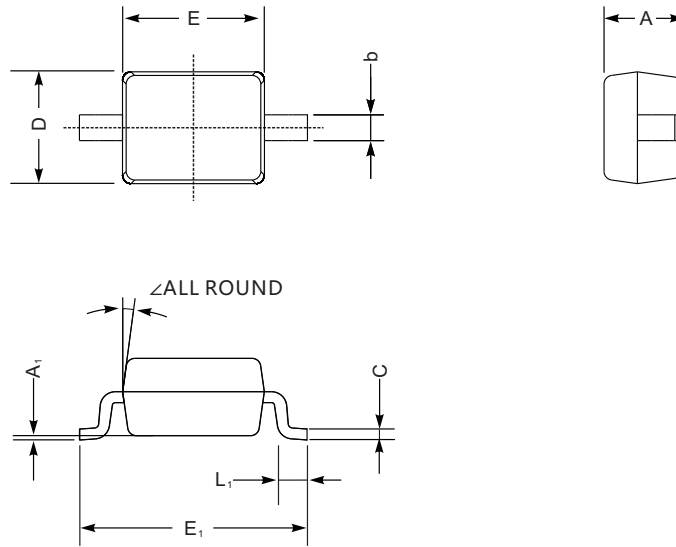

Fig.5 Typical Junction Capacitance





SOD-323 mechanical data

UNIT		A	C	D	E	E ₁	b	L ₁	A ₁	∠
mm	max	1.1	0.15	1.4	1.8	2.75	0.4	0.45	0.2	9°
	min	0.8	0.08	1.2	1.4	2.55	0.25	0.2	—	
mil	max	43	5.9	55	70	108	16	16	8	
	min	32	3.1	47	63	100	9.8	7.9	—	

■ The recommended mounting pad size

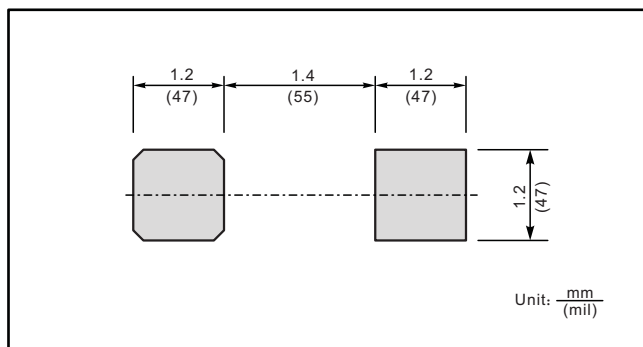

Summary of Packing Options

Package	Packing Description	Packing Quantity	Industry Standard
SOD-323	Tape/Reel, 7" reel	3000	EIA-481-1

单击下面可查看定价，库存，交付和生命周期等信息

[>>YFW\(佑风微\)](#)