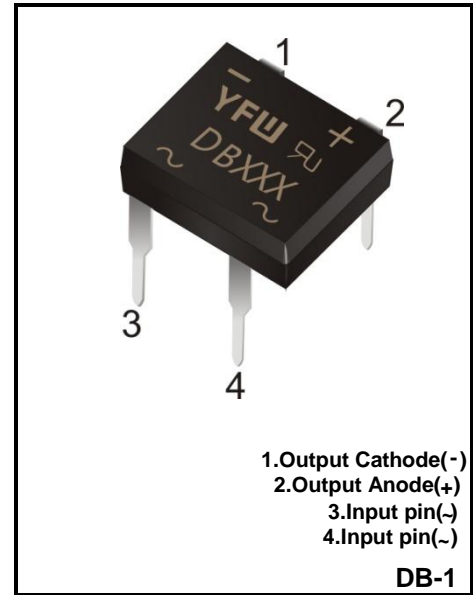


**1.0A GLASS PASSIVATED BRIDGE RECTIFIER**
**Reverse Voltage - 100 to 1000 V**
**Forward Current – 1.0A**
**FEATURES**

- ◆High current capability
- ◆Low forward voltage drop
- ◆Glass Passivated Chip Junction
- ◆Low power loss, high efficiency
- ◆Lead free in comply with EU RoHS 2011/65/EU directives

**MECHANICAL DATA**

- ◆Case: DB-1
- ◆Terminals: Solderable per MIL-STD-202, Method 208
- ◆Approx. Weight: 0.4g /0.02oz


**Maximum Ratings and Electrical characteristics**

Ratings at 25 °C ambient temperature unless otherwise specified.

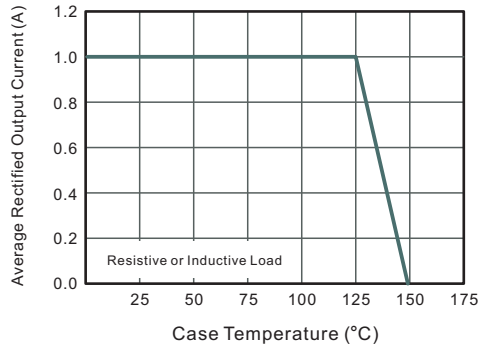
Single phase half-wave 60 Hz, resistive or inductive load, for capacitive load current derate by 20 %.

Parameter	Symbols	DB102	DB103	DB104	DB105	DB106	DB107	Units
Maximum Repetitive Peak Reverse Voltage	$V_{RRM}$	100	200	400	600	800	1000	V
Maximum RMS voltage	$V_{RMS}$	70	140	280	420	560	700	V
Maximum DC Blocking Voltage	$V_{DC}$	100	200	400	600	800	1000	V
Average Rectified Output Current	$I_{(AV)}$	1						A
Peak Forward Surge Current 8.3 ms Single Half Sine-Wave Superimposed on Rated Load(JEDEC method)	$I_{FSM}$	50						A
Forward Voltage per element @ $I_F=1.0A$ and 25°C	$V_F$	1.1						V
Maximum DC Reverse Current @ $T_A=25^\circ C$ at Rated DC Blocking Voltage @ $T_A=125^\circ C$	$I_R$	5 500						$\mu A$
Typical Junction Capacitance <sup>(Note1)</sup>	$C_j$	25						pF
Typical Thermal Resistance <sup>(Note2)</sup>	$R_{\theta JA}$ $R_{\theta JC}$	40/15						°C/W
Operating and Storage Temperature Range	$T_j$ $T_{stg}$	-55 ~ +150						°C

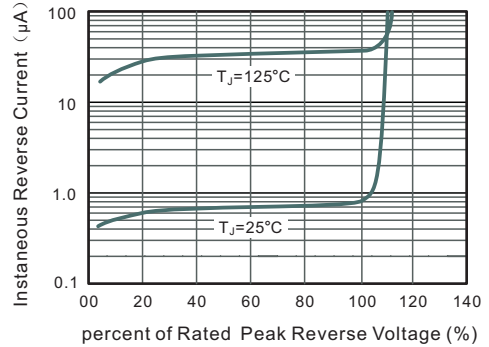
(1) Measured at 1 MHz and applied reverse voltage of 4 V D.C

(2) Mounted on glass epoxy PCB board with 4x1.5"x1.5" (3.81x3.81 cm) copper pad.

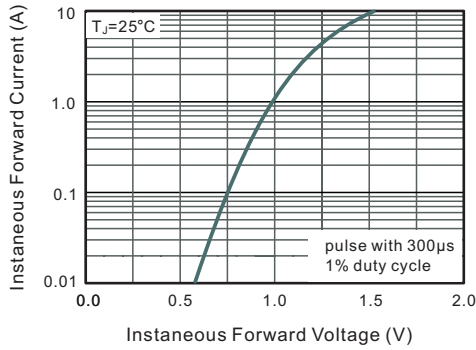
**Fig.1 Average Rectified Output Current Derating Curve**



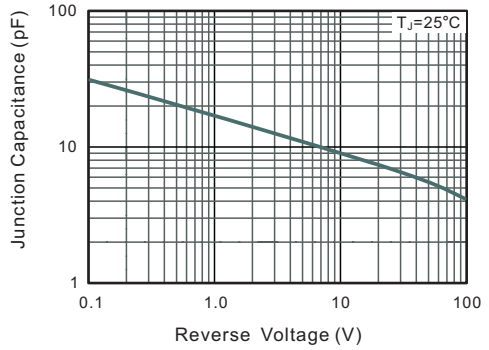
**Fig.2 Typical Reverse Characteristics**



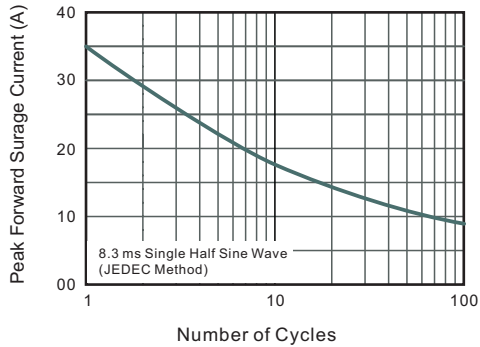
**Fig.3 Typical Instantaneous Forward Characteristics**



**Fig.4 Typical Junction Capacitance**

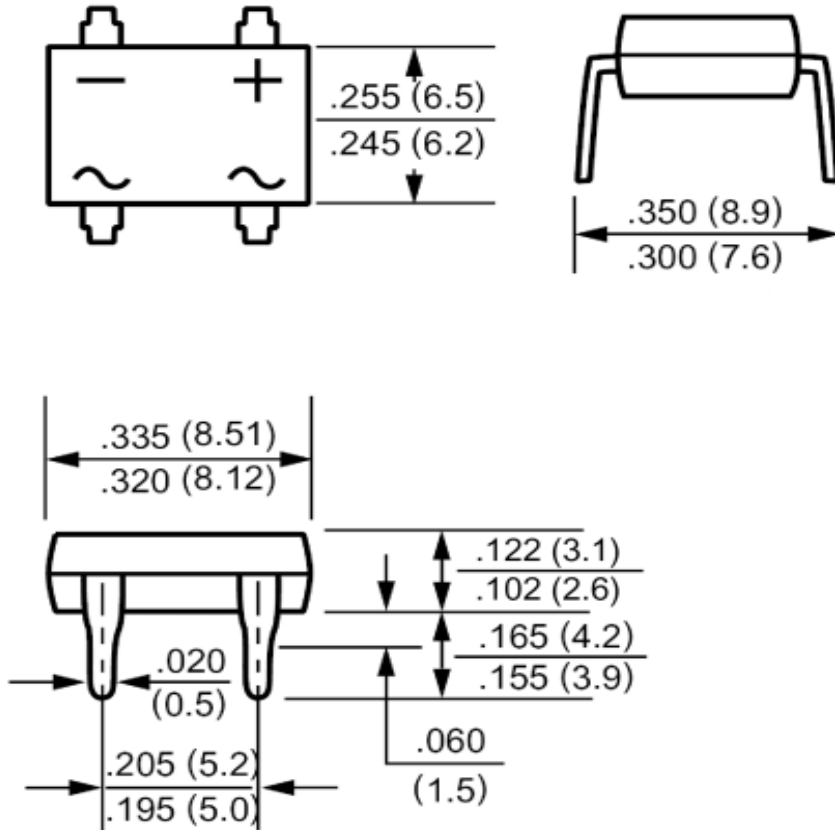


**Fig.5 Maximum Non-Repetitive Peak Forward Surge Current**



Package Outline

DB-1



Summary of Packing Options

Package	Packing Description	Packing Quantity	Industry Standard
DB-1	Tube	50	EIA-481-1

单击下面可查看定价，库存，交付和生命周期等信息

[>>YFW\(佑风微\)](#)