

## Surface Mount Schottky Barrier Rectifier

Reverse Voltage - 20 to 200 V

Forward Current - 3 A

### FEATURES

- ◆Metal silicon junction, majority carrier conduction
- ◆For surface mounted applications
- ◆Low power loss, high efficiency
- ◆High forward surge current capability
- ◆For use in low voltage, high frequency inverters, free wheeling, and polarity protection applications
- ◆Lead free in comply with EU RoHS 2011/65/EU directives

### MECHANICAL DATA

- ◆Case: SMAF
- ◆Terminals: Solderable per MIL-STD-750, Method 2026
- ◆Approx. Weight: 27mg / 0.00095oz

### Pinning

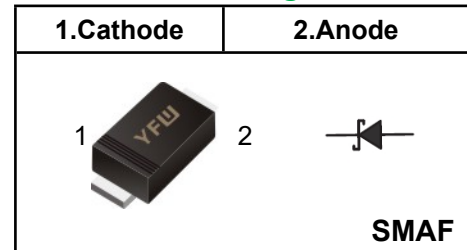

### Marking Code

<b>SS32F</b>	<b>SS32</b>
<b>SS34F</b>	<b>SS34</b>
<b>SS36F</b>	<b>SS36</b>
<b>SS38F</b>	<b>SS38</b>
<b>SS310F</b>	<b>SS310</b>
<b>SS312F</b>	<b>SS312</b>
<b>SS315F</b>	<b>SS315</b>
<b>SS320F</b>	<b>SS320</b>

### Absolute Maximum Ratings and Electrical characteristics

Ratings at 25 ° ambient temperature unless otherwise specified. Single phase, half wave, 60Hz resistive or inductive load, for capacitive load, derate by 20 %

Parameter	Symbols	SS32F	SS34F	SS36F	SS38F	SS310F	SS312F	SS315F	SS320F	Units
Maximum Repetitive Peak Reverse Voltage	$V_{RRM}$	20	40	60	80	100	120	150	200	V
Maximum RMS voltage	$V_{RMS}$	14	28	42	56	70	84	105	140	V
Maximum DC Blocking Voltage	$V_{DC}$	20	40	60	80	100	120	150	200	V
Maximum Average Forward Rectified Current	$I_{F(AV)}$	3.0								A
Peak Forward Surge Current, 8.3ms Single Half Sine-wave Superimposed On Rated Load (JEDEC method)	$I_{FSM}$	80				70				A
Maximum Instantaneous Forward Voltage at 3 A	$V_F$	0.55	0.70		0.85		0.95		V	
Maximum Instantaneous Reverse Current at Rated DC Reverse Voltage <small><math>T_A = 25^{\circ}C</math> <math>T_A = 100^{\circ}C</math></small>	$I_R$	0.5 5			0.3 3				mA	
Typical Junction Capacitance <sup>(1)</sup>	$C_j$	250			180				pF	
Typical Thermal Resistance <sup>(2)</sup>	$R_{\theta JA}$	70								°C/W
Operating Junction Temperature Range	$T_j$	-55 ~ +150								°C
Storage Temperature Range	$T_{stg}$	-55 ~ +150								°C

(1) Measured at 1 MHz and applied reverse voltage of 4 V D.C

(2) P.C.B. mounted with 2.0" X 2.0" (5 X 5 cm) copper pad areas.

**Fig.1 Forward Current Derating Curve**

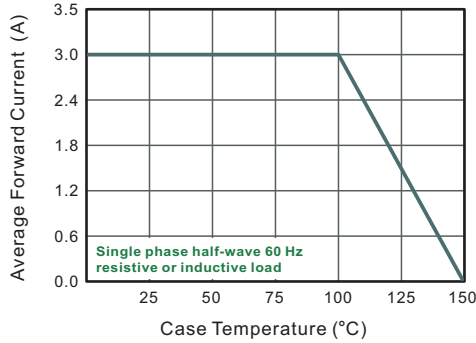

**Fig.2 Typical Reverse Characteristics**

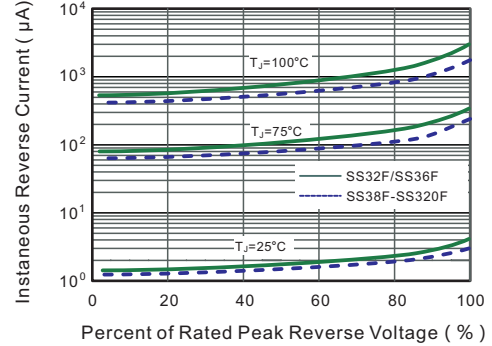

**Fig.3 Typical Forward Characteristic**

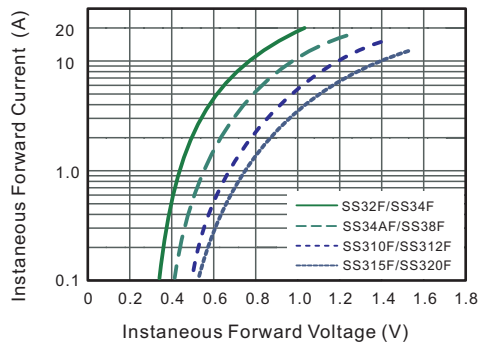

**Fig.4 Typical Junction Capacitance**

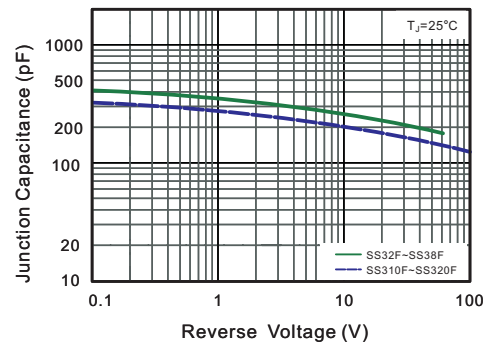

**Fig.5 Maximum Non-Repetitive Peak Forward Surge Current**

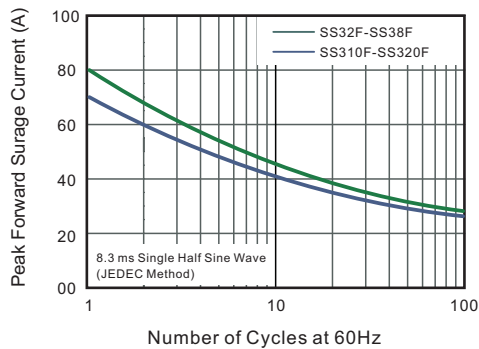

**Fig.5- Typical Transient Thermal Impedance**

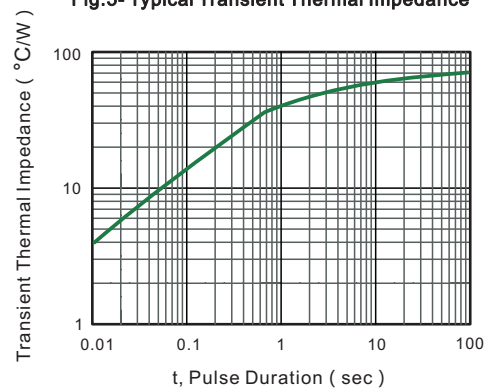

**Package Outline**

**SMAF**

Plastic surface mounted package; 2 leads

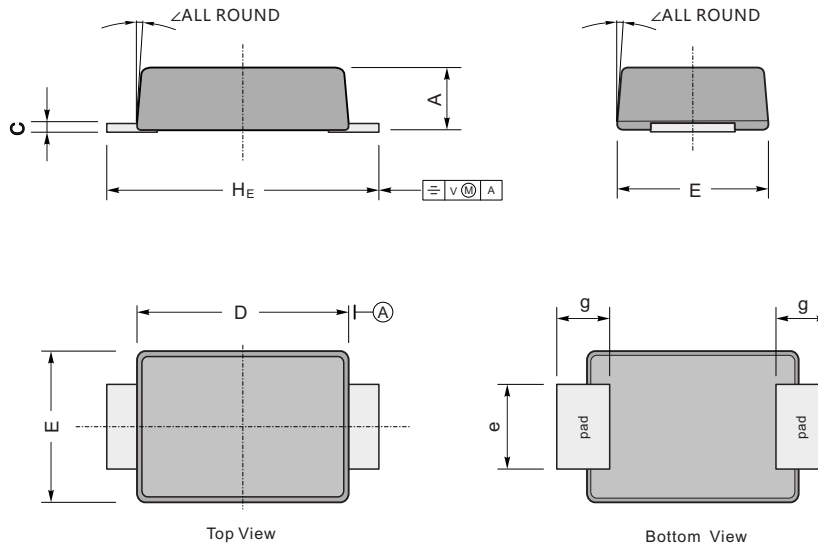

UNIT		A	C	D	E	e	g	H <sub>E</sub>	∠
mm	max	1.1	0.20	3.7	2.7	1.6	1.2	4.9	7°
	min	0.9	0.12	3.3	2.4	1.3	0.8	4.4	
mil	max	43	7.9	146	106	63	47	193	
	min	35	4.7	130	94	51	31	173	

**The recommended mounting pad size**

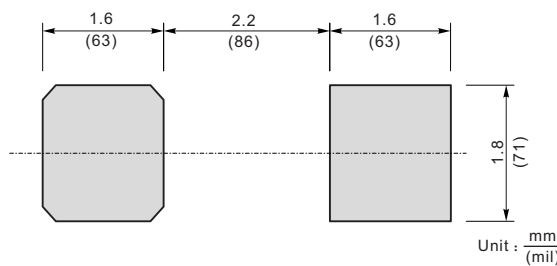

**Summary of Packing Options**

Package	Packing Description	Packing Quantity	Industry Standard
SMAF	Tape/Reel, 13" reel	10000	EIA-481-1
	Tape/Reel, 7" reel	3000	EIA-481-1

单击下面可查看定价，库存，交付和生命周期等信息

[>>YFW\(佑风微\)](#)