

16A 3Quadrants TRIACs

Product Summary

Symbol	Value	Unit
$I_{T(AV)}$	16	A
$V_{DRM} V_{RRM}$	600/800	V
V_{TM}	1.55	V

Features

With high ability to withstand the shock loading of large current, With high commutation performances, 3 quadrants products especially recommended for use on inductive load.

Application

Washing machine, vacuums, massager, solid state relay, AC Motor speed regulation and so on.

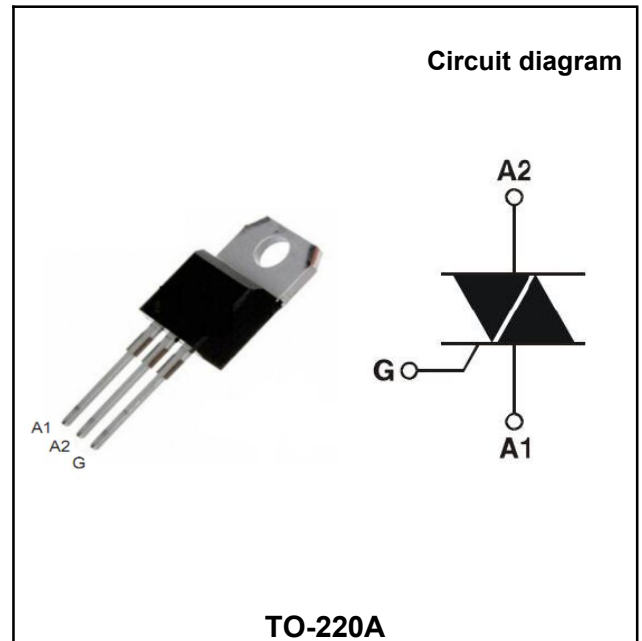

Order Information

Part Number	Package	Marking	Packing	Packing Quantity
BTA16	TO-220A	BTA16 600BW XXXX	box	1000PCS/box

Absolute maximum ratings (Ta=25°C unless otherwise noted)

Parameter	Symbol	Value	Unit
Repetitive peak off-state voltage	V_{DRM}	600/800	V
Repetitive peak reverse voltage	V_{RRM}	600/800	V
RMS on-state current	$I_T(RMS)$	16	A
Non repetitive surge peak on-state current (full cycle, F=50Hz)	I_{TSM}	160	A
I^2t value for fusing (tp=10ms)	I^2t	140	A ² s
Critical rate of rise of on-state current ($I_G = 2 \times I_{GT}$)	di/dt	I - II - III 50	A/ μ s
Peak gate current	I_{GM}	4	A
Average gate power dissipation	$P_G (AV)$	1	W
Junction Temperature	T_J	-40~+125	°C
Storage Temperature	T_{STG}	-40 ~+150	°C

Electrical characteristics (TA=25°C, unless otherwise noted)

Parameter	Symbol	Test Condition		Value		Unit
				CW	BW	
Gate trigger current	I_{GT}	$V_D=12V$ $R_L=33\Omega$ $T_J=25^\circ C$	I-II-III	≤ 35	≤ 50	mA
Gate trigger voltage	V_{GT}		I-II-III	≤ 1.3		V
Gate non-trigger voltage	V_{GD}	$V_D = V_{DRM} T_J=125^\circ C$		≥ 0.2		V
latching current	I_L	$I_G=1.2I_{GT}$	I-III	≤ 50	≤ 70	mA
			II	≤ 60	≤ 80	
Holding current	I_H	$I_T = 500mA$		≤ 30	≤ 50	mA
Critical-rate of rise of commutation voltage	dV_D/dt	$V_D=2/3V_{DRM}$ Gate Open $T_J=125^\circ C$		≥ 500	≥ 1000	V/μs

STATIC CHARACTERISTICS

Forward "on" voltage	V_{TM}	$I_{TM} = 23A$ $t_p=380\mu s$		≤ 1.55	V
Repetitive Peak Off-State Current	I_{DRM}	$V_D=V_{DRM}$ $V_R=V_{RRM}$	$T_J=25^\circ C$	≤ 5	μA
Repetitive Peak Reverse Current	I_{RRM}		$T_J=125^\circ C$	≤ 1	mA

THERMAL RESISTANCES

Thermal resistance	$R_{th(j-c)}$	Junction to case(AC)	2.1	$^\circ C/W$
	$R_{th(j-a)}$	Junction to ambient	60	$^\circ C/W$

Ordering Information

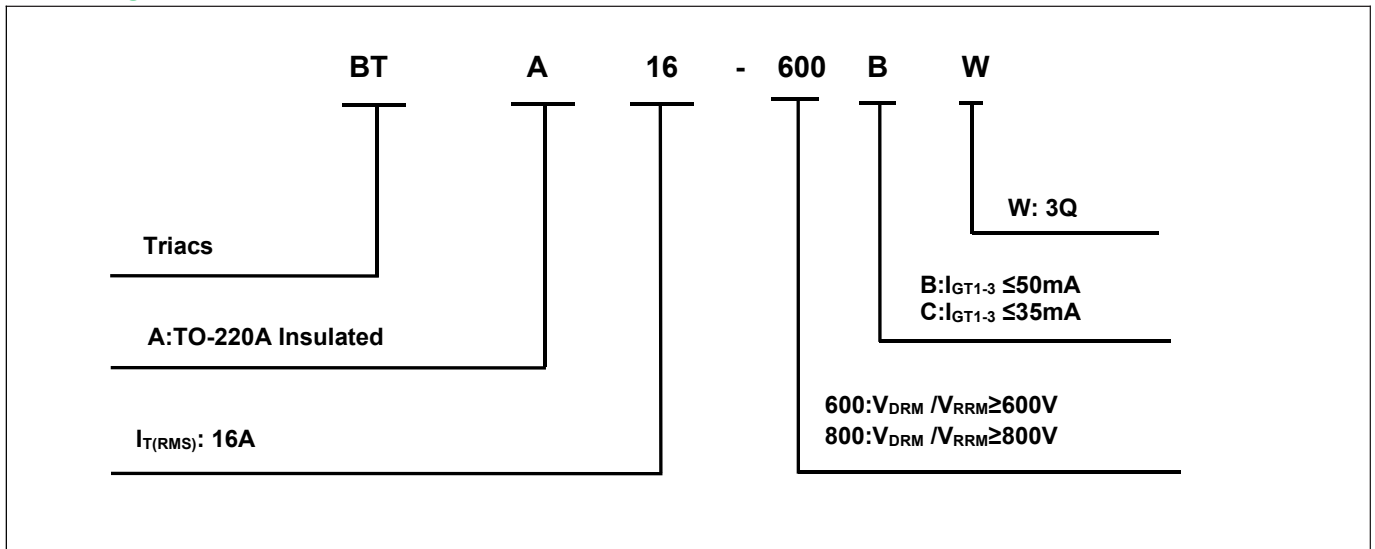

Typical Characteristics

FIG.1: Maximum power dissipation versus RMS on-state current (full cycle)

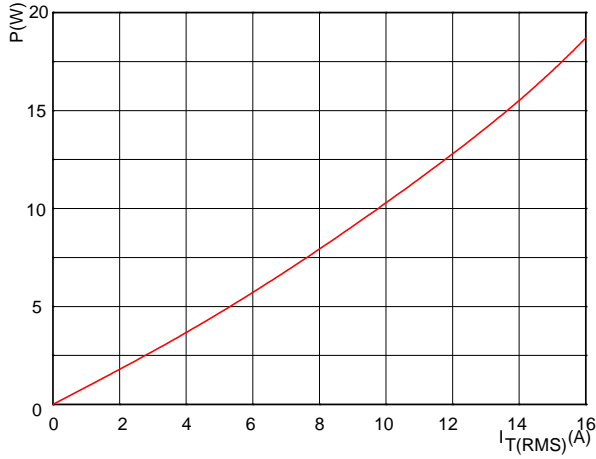

FIG.2: RMS on-state current versus case temperature (full cycle)

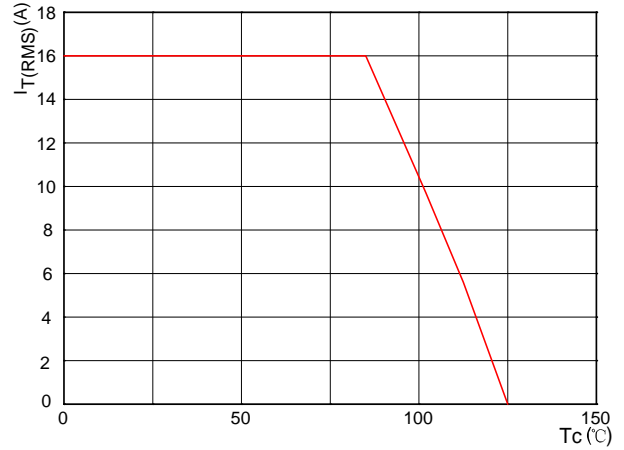

FIG.3: Surge peak on-state current versus number of cycles

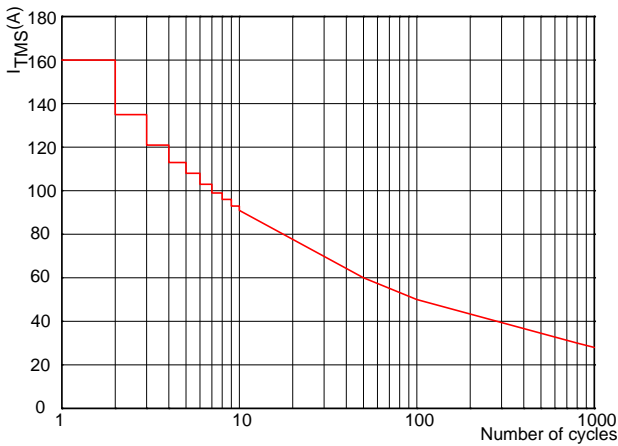

FIG.4: On-state characteristics (maximum values)

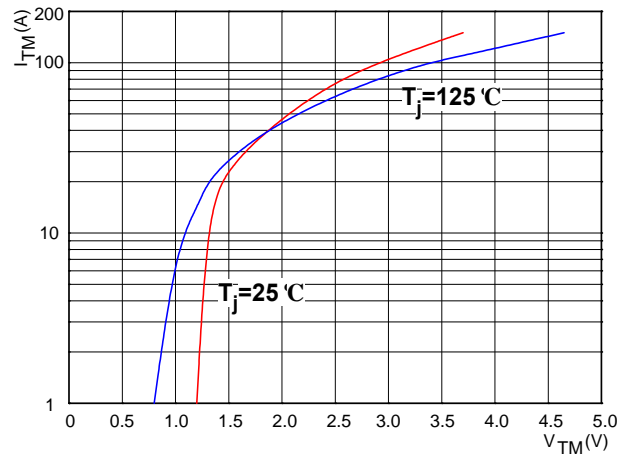

FIG.5: Non-repetitive surge peak on-state current for a sinusoidal pulse with width $t_p < 10\text{ms}$

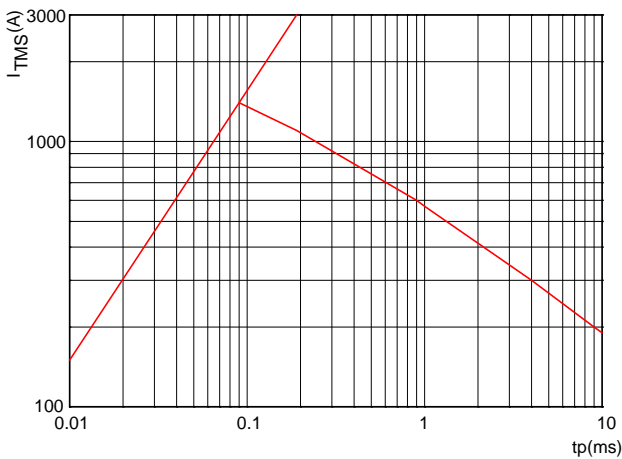
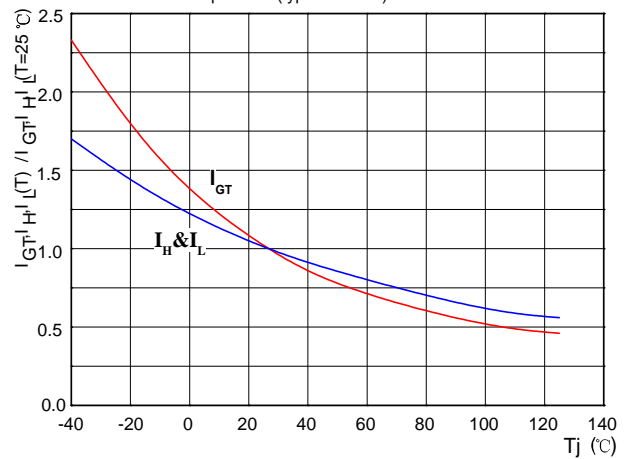
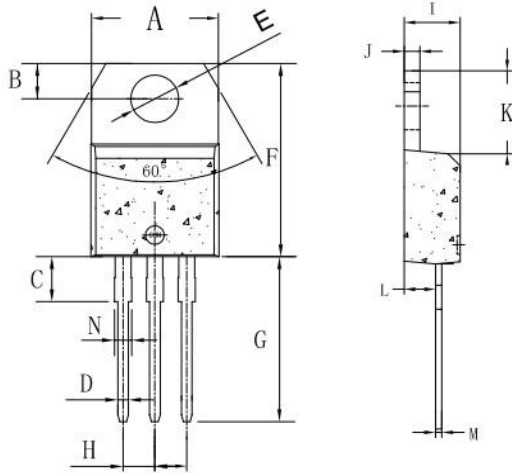

FIG.6: Relative variations of gate trigger current, holding current and latching current versus junction temperature (typical values)



Package Information

TO-220A



Symbol	Dimensions In Millimeters		Dimensions In Inches	
	Min	Max	Min	Max
A	9.8	10.4	0.385	0.409
B	2.65	3.1	0.104	0.122
C	2.8	4.2	0.110	0.165
D	0.7	0.92	0.027	0.036
E	3.75	3.95	0.147	0.155
F	14.8	16.1	0.582	0.633
G	13.05	13.6	0.513	0.535
H	2.4	2.7	0.094	0.106
I	4.38	4.61	0.172	0.181
J	1.15	1.36	0.045	0.053
K	5.85	6.82	0.230	0.268
L	2.35	2.75	0.092	0.108
M	0.35	0.65	0.013	0.025
N	1.18	1.42	0.046	0.055

单击下面可查看定价，库存，交付和生命周期等信息

[>>YFW\(佑风微\)](#)