

25A HIGH CURRENT SINGLE-PHASE SILICON BRIDGE RECTIFIER

Voltage - 600 to 1600 V

Forward Current – 25 A

FEATURES

- ◆ High current capability
- ◆ Low forward voltage drop
- ◆ Glass Passivated Chip Junction
- ◆ Low power loss, high efficiency
- ◆ Lead free in comply with EU RoHS 2011/65/EU directives

MECHANICAL DATA

- ◆ Case: KBPC, KBPC-W
- ◆ Terminals: Solderable per MIL-STD-202, Method 208
- ◆ Approx. Weight: KBPC 31.6g , KBPC-W 28.5g

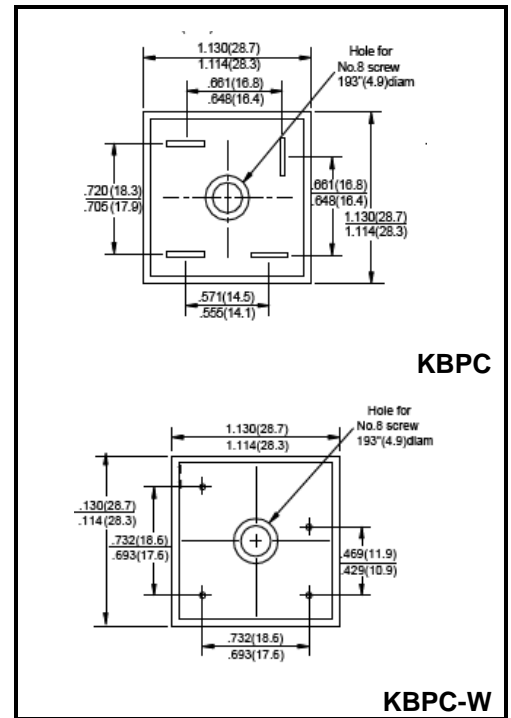

Maximum Ratings and Electrical characteristics

Ratings at 25 °C ambient temperature unless otherwise specified.

Parameter	Symbols	KBPC2506 (W)	KBPC2508 (W)	KBPC2510 (W)	KBPC2512 (W)	KBPC2516 (W)	Units
Maximum Repetitive Peak Reverse Voltage	V_{RRM}	600	800	1000	1200	1600	V
Maximum RMS voltage	V_{RMS}	420	560	700	840	980	V
Maximum DC Blocking Voltage	V_{DC}	600	800	1000	1200	1600	V
Maximum Average Forward Rectified Current at TC=60°C	$I_{(AV)}$	25					A
Peak Forward Surge Current 8.3 ms Single Half Sine-Wave Superimposed on Rated Load (JEDEC method)	I_{FSM}	400					A
Maximum Forward Voltage at 12.5A DC and 25°C	V_F	1.1					V
Maximum Reverse Current at TA=25°C at Rated DC Blocking Voltage TA=125°C	I_R	10 1.0					μA mA
Operating and Storage Temperature Range	T_j, T_{stg}	-55 ~ +150					°C

(1) Measured at 1 MHz and applied reverse voltage of 4 V D.C

(2) Thermal Resistance Junction to Case, Lead and Ambient.

FIG.1-MAXIMUM FORWARD SURGE CURRENT

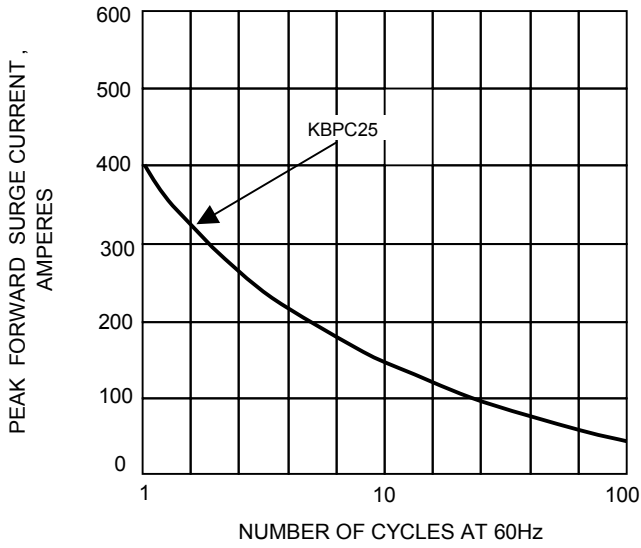

FIG.2- DERATING CURVE
OUTPUT RECTIFIED CURRENT

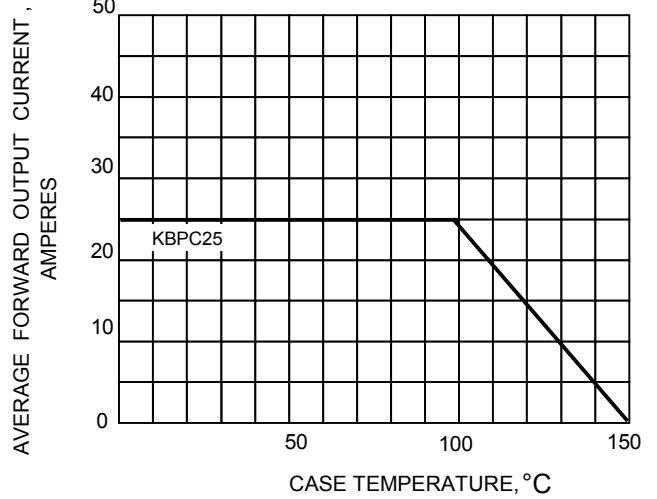

FIG.3-TYPICAL FORWARD CHARACTERISTICS

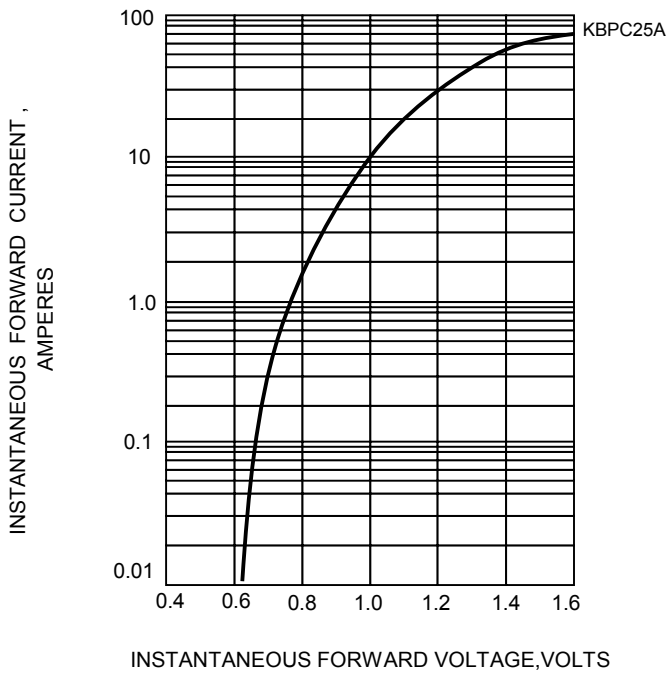
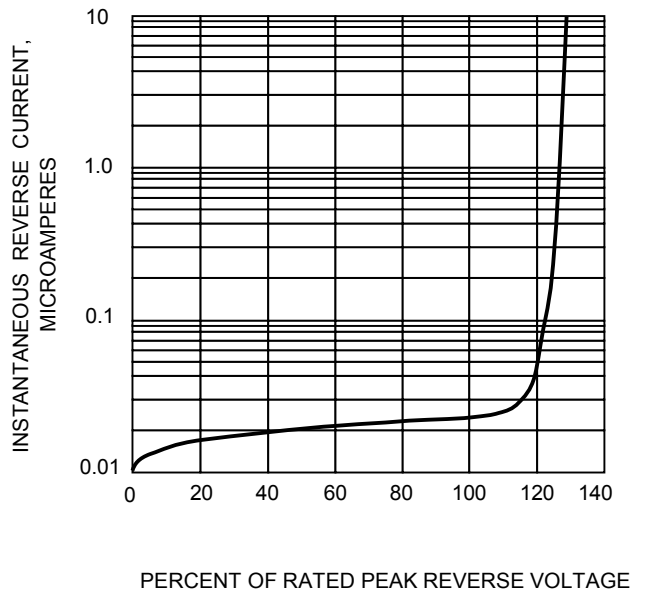

FIG.4-TYPICAL REVERSE CHARACTERISTICS



Package Outline

KBPC

KBPC-W

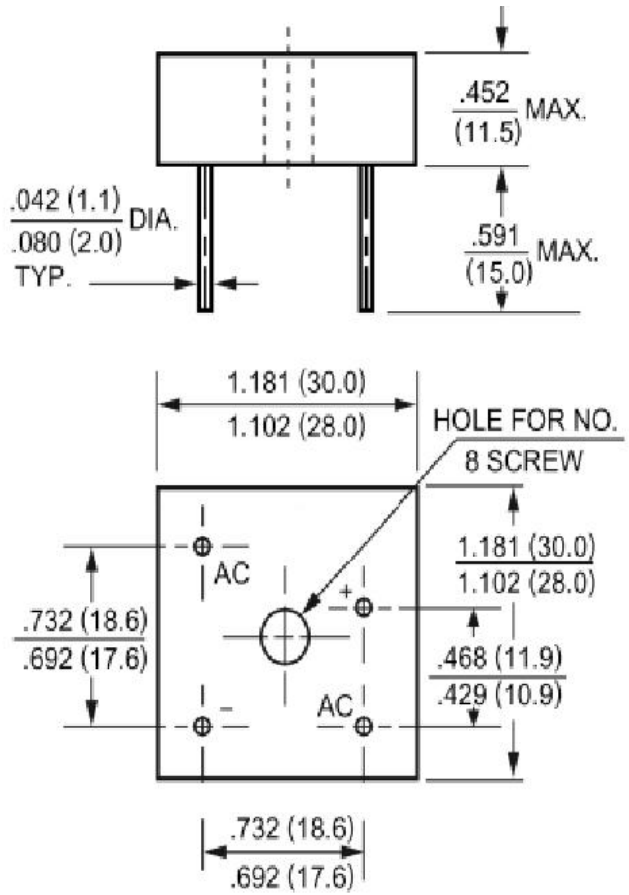
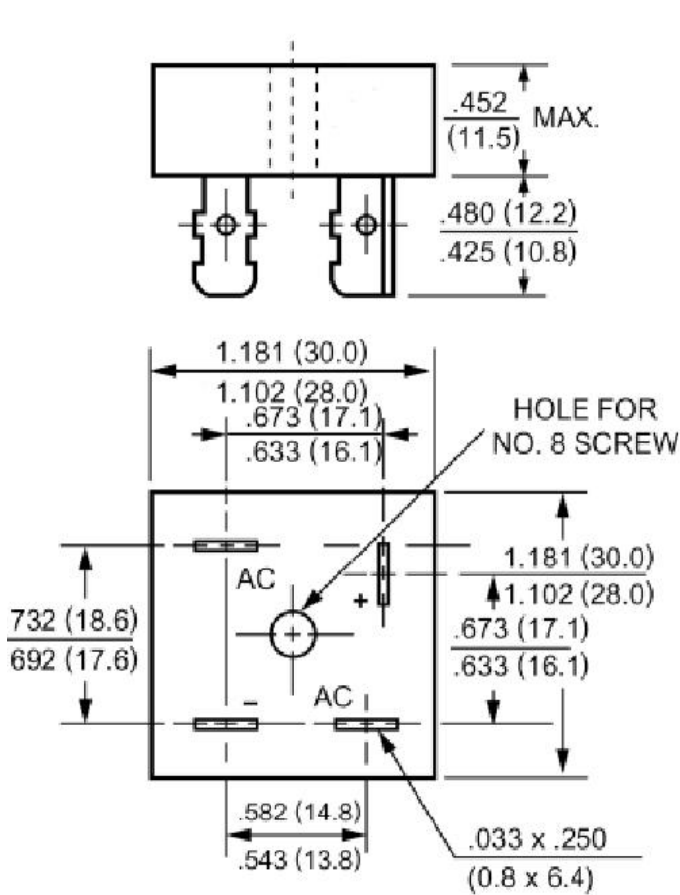

Summary of Packing Options

Package	Package Description	Packing Quantity	Industry Standard
KBPC	BOX	50	EIA-481-1
KBPC-W	BOX	50	EIA-481-1

单击下面可查看定价，库存，交付和生命周期等信息

[>>YFW\(佑风微\)](#)