

2.0A GLASS PASSIVATED BRIDGE RECTIFIER

Reverse Voltage - 100 to 1000 V

Forward Current – 2.0A

FEATURES

- ◆High current capability
- ◆Low forward voltage drop
- ◆Glass Passivated Chip Junction
- ◆Low power loss, high efficiency
- ◆Lead free in comply with EU RoHS 2011/65/EU directives

MECHANICAL DATA

- ◆Case: DB-1
- ◆Terminals: Solderable per MIL-STD-202, Method 208
- ◆Approx. Weight: 0.4g /0.02oz

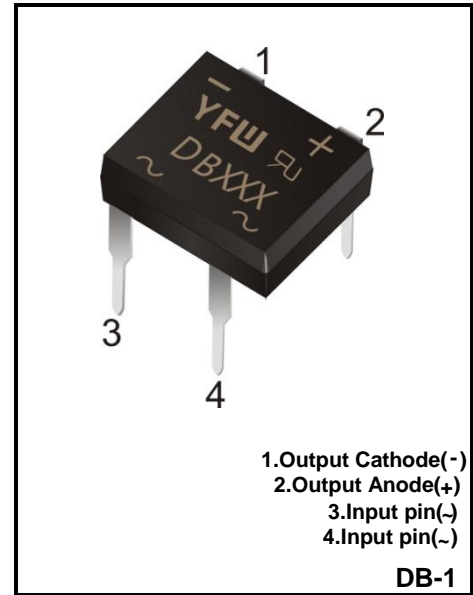

Maximum Ratings and Electrical characteristics

Ratings at 25 °C ambient temperature unless otherwise specified.

Single phase half-wave 60 Hz, resistive or inductive load, for capacitive load current derate by 20 %.

Parameter	Symbols	DB202	DB203	DB204	DB205	DB206	DB207	Units
Maximum Repetitive Peak Reverse Voltage	V_{RRM}	100	200	400	600	800	1000	V
Maximum RMS voltage	V_{RMS}	70	140	280	420	560	700	V
Maximum DC Blocking Voltage	V_{DC}	100	200	400	600	800	1000	V
Average Rectified Output Current	$I_{(AV)}$	2						A
Peak Forward Surge Current 8.3 ms Single Half Sine-Wave Superimposed on Rated Load(JEDEC method)	I_{FSM}	60						A
Forward Voltage per element @ $I_F=2.0A$ and 25°C	V_F	1.1						V
Maximum DC Reverse Current @ $T_A=25^{\circ}C$ at Rated DC Blocking Voltage @ $T_A=125^{\circ}C$	I_R	5 500						μA
Typical Junction Capacitance ^(Note1)	C_j	25						pF
Typical Thermal Resistance ^(Note2)	$R_{\theta JA} R_{\theta JC}$	40/15						°C/W
Operating and Storage Temperature Range	T_j, T_{stg}	-55 ~ +150						°C

(1) Measured at 1 MHz and applied reverse voltage of 4 V D.C

(2) Mounted on glass epoxy PCB board with 4x1.5"x1.5" (3.81x3.81 cm) copper pad.

Fig.1 Average Rectified Output Current Derating Curve

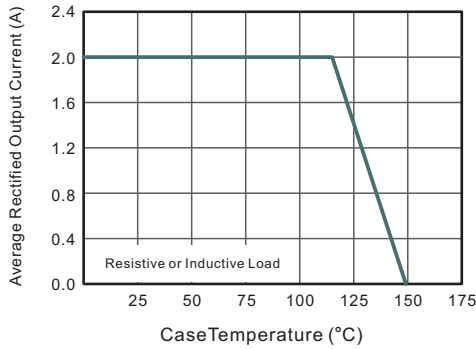

Fig.2 Typical Reverse Characteristics

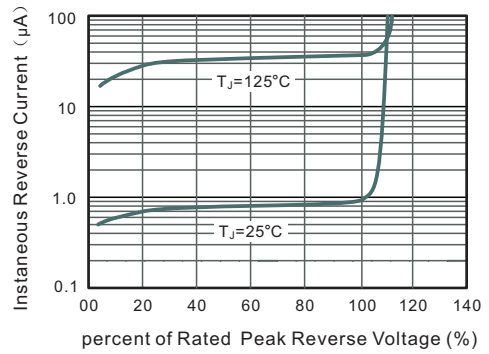

Fig.3 Typical Instantaneous Forward Characteristics

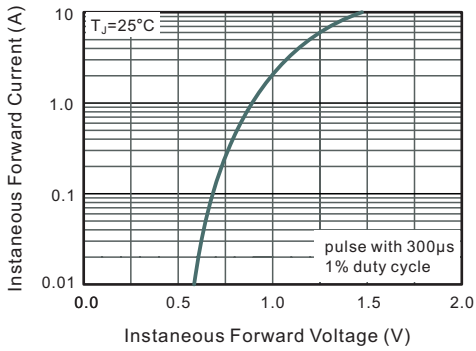

Fig.4 Typical Junction Capacitance

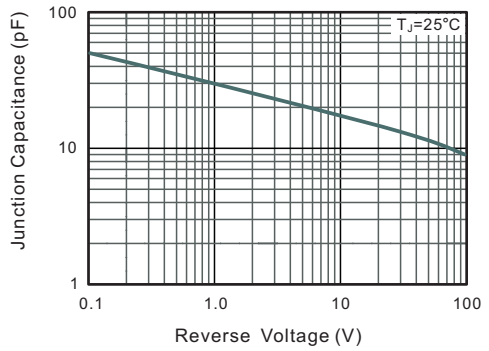
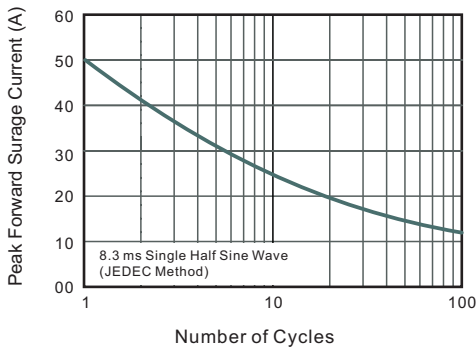
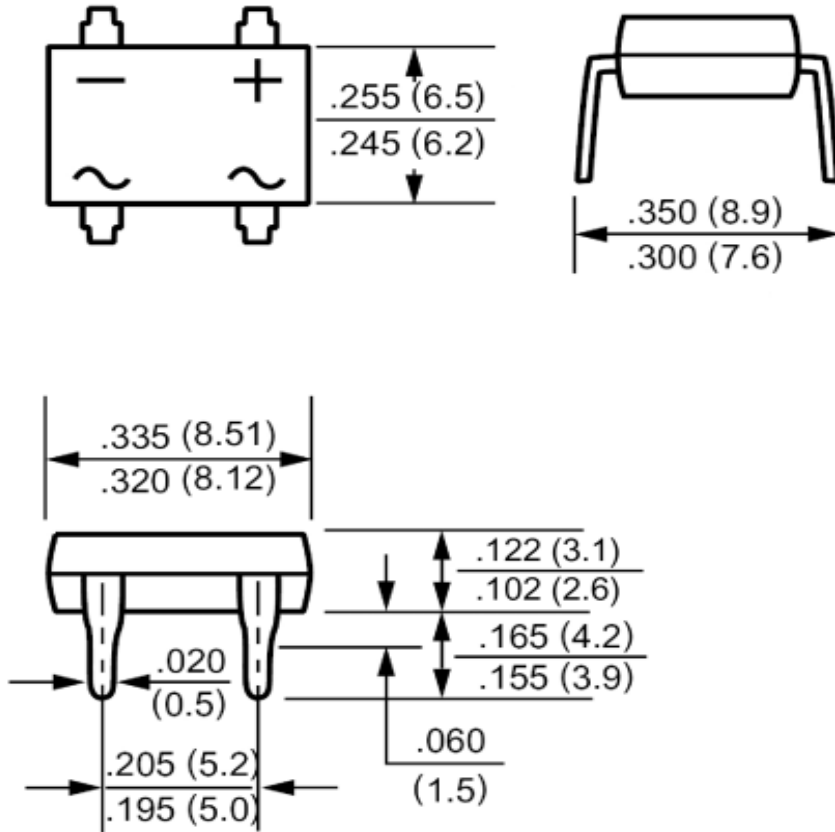

Fig.5 Maximum Non-Repetitive Peak Forward Surge Current



Package Outline

DB-1



Summary of Packing Options

Package	Packing Description	Packing Quantity	Industry Standard
DB-1	Tube	50	EIA-481-1

单击下面可查看定价，库存，交付和生命周期等信息

[>>YFW\(佑风微\)](#)