

Surface Mounted Schottky Barrier Rectifiers

Reverse Voltage - 40V ~ 100V

Forward Current - 20 A

FEATURES

- ◆ The plastic package carries Underwriters Laboratory Flammability Classification 94V-0
- ◆ For surface mounted applications
- ◆ Built-in strain relief, ideal for automated placement
- ◆ Low forward voltage drop
- ◆ High forward surge current capability
- ◆ High temperature soldering guaranteed
250°C/10 seconds at terminals

MECHANICAL DATA

- ◆ Case: Molded plastic body
- ◆ Terminals: Solder plated, solderable per MIL-STD-750, Method 2026
- ◆ Polarity: Polarity symbol marking on body
- ◆ Mounting Position: Any
- ◆ Weight: 0.003 ounce, 0.092 grams

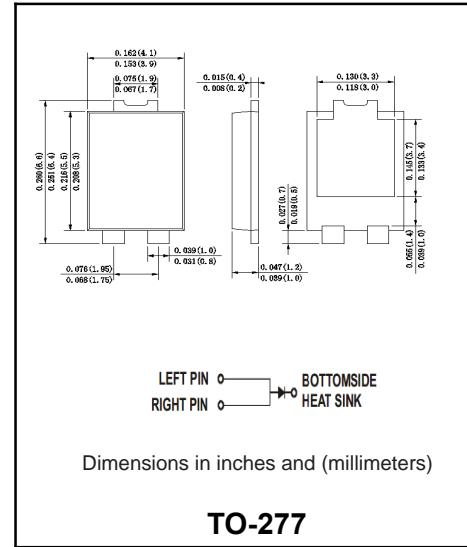

Maximum Ratings And Electrical Characteristics

Ratings at 25°C ambient temperature unless otherwise specified. Single phase half-wave 60Hz, resistive or inductive load, for capacitive load current derate by 20%.

Parameter	SYMBOLS	20L40SP	20L45SP	20L50SP	20L60SP	20L80SP	20L100SP	UNITS
Maximum repetitive peak reverse voltage	V_{RRM}	40	45	50	60	80	100	V
Maximum RMS voltage	V_{RMS}	28	31.5	35	42	56	70	V
Maximum DC blocking voltage	V_{DC}	40	45	50	60	80	100	V
Maximum average forward rectified current at $T_L=100^\circ\text{C}$	$I_{(AV)}$	20.0						A
Peak forward surge current, 8.3ms single half sine-wave superimposed on rated load	I_{FSM}	300.0						A
Maximum instantaneous forward voltage at 2.0A at 20.0A	V_F		0.35 0.48		0.40 0.55	0.45 0.70		V
Maximum DC reverse current $T_A=25^\circ\text{C}$ at rated DC blocking voltage $T_A=125^\circ\text{C}$	I_R		0.5 50			0.2 20		mA
Typical thermal resistance	R_{qJA}	60.0						$^\circ\text{C}/\text{W}$
Operating junction temperature range	T_J	-55 to +150						$^\circ\text{C}$
Storage temperature range	T_{STG}	-55 to +150						$^\circ\text{C}$

Ratings And Characteristic Curves

FIG. 1- DERATING CURVE OUTPUT RECTIFIED CURRENT

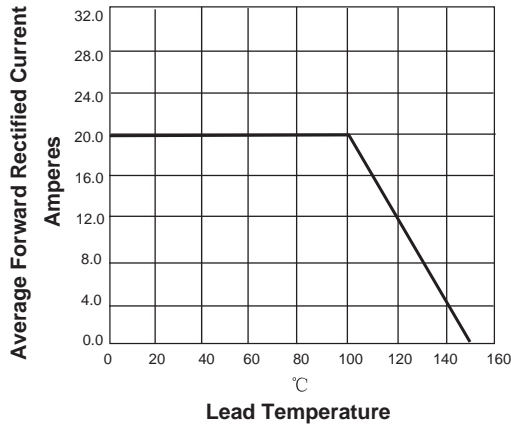

FIG. 2-MAXIMUM NON-REPETITIVE PEAK FORWARD SURGE CURRENT PER LEG

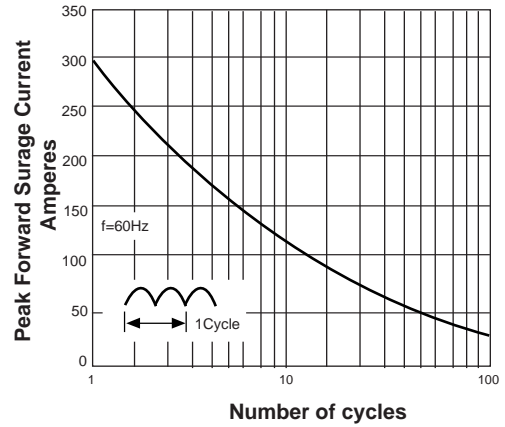

FIG. 3-TYPICAL FORWARD VOLTAGE CHARACTERISTICS

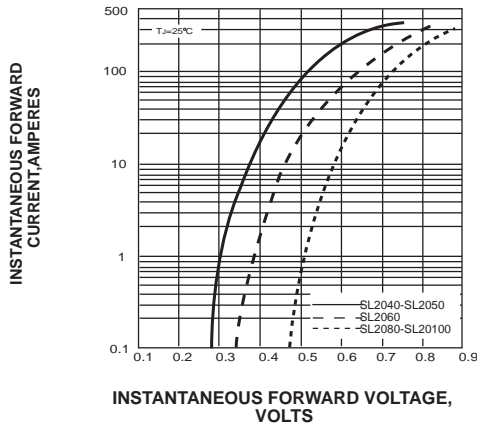
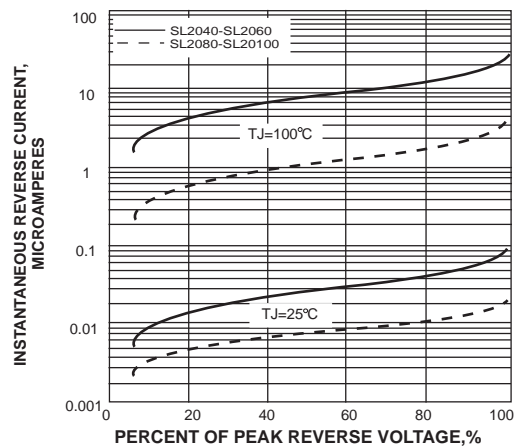
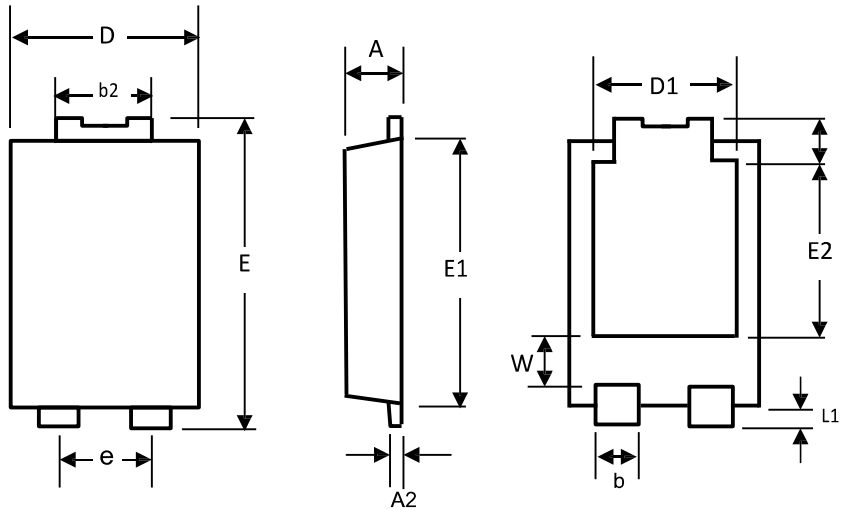

FIG. 4-TYPICAL REVERSE LEAKAGE CHARACTERISTICS



Package Outline TO-277

Plastic surface mounted package; 3 leads



Dim	Min	Max
A	1.1	1.2
A2	0.3	0.4
b1	0.8	1
b2	1.7	1.9
D	3.9	4.1
D1	3.054	
E	6.4	6.6
e	1.84	
E1	5.3	5.5
E2	3.549	
L	0.8	1
L1	0.5	0.7
W	1.1	1.4

unit:mm

Mounting Pad Layout

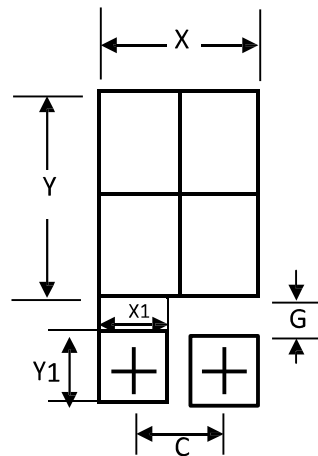

Dim	Min
C	1.8
G	0.9
X	3.4
X1	1.4
Y	4.9
Y1	1.4

unit:mm

Summary of Packing Options

Package	Packing Description	Packing Quantity	Industry Standard
TO-277	Tape/Reel,13"reel	5000	EIA-481-1

单击下面可查看定价，库存，交付和生命周期等信息

[>>YFW\(佑风微\)](#)