

Surface mount transient voltage suppressor power 200 watts

Reverse Voltage -5.0V to 440 V

Forward Current - 20 A

FEATURES

- ◆ For surface mounted applications in order to optimize board space.
- ◆ Low profile package
- ◆ Glass passivated junction
- ◆ Low inductance
- ◆ Plastic package has Underwriters Laboratory Flammability

MECHANICAL DATA

- ◆ Case: SOD-123FL
- ◆ Terminals: Solderable per MIL-STD-750, Method 2026
- ◆ Approx. Weight: 15mg/0.00048oz

Maximum Ratings and Electrical characteristics

Ratings at 25 °C ambient temperature unless otherwise specified.

| Parameter | Symbol | Value | Unit |
|--|--------------------|-------------|------|
| Peak Pulse Power Dissipation on TA=25°C (Note 1,2,5, Fig1) | P_{PPM} | 200 | W |
| Peak Forward Surge Current (Note 3) | I_{FSM} (UNI) | 20 | A |
| Peak Pulse Current on 10/1000 us waveform (Note 1 Fig)2 | I_{PPM} | see Table 1 | A |
| Steady State Power Dissipation (Note 4) | $P_{M(AV)}$ | 1 | W |
| Operating Junction and Storage Range | T_J, T_{STG} | -55 to +150 | °C |
| Typical Thermal Resistance | $R_{\theta JA}$ | 180 | °C/W |

NOTES

1. Non-repetitive current pulse per Fig 3 and derated above $T_A=25^\circ\text{C}$ per Fig 2
2. Mounted on 5mm² copper pads to each terminal
3. 8.3ms single half sinewave, or equivalent square wave duty cycle=4 pulses per minutes maximum
4. lead temperature at $T_L=75^\circ\text{C}$
5. Peak pulse powe. waveform is tp=10/1000us
6. A transient suppressor is selected according to the working peak reverse voltage(V_{RWM}), Which Should be equal to or greater than the DC or continuous peak operating voltage level

Pinning

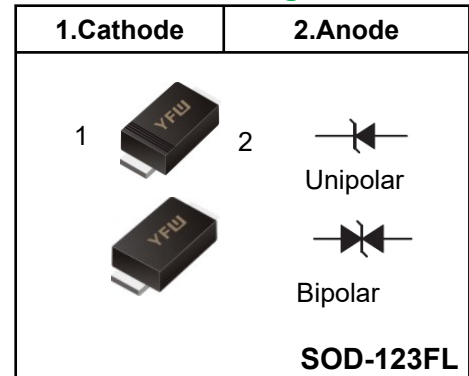

Characteristics at Ta = 25°C

| Type | | Marking | | VRMW | Breakdown Voltage | | Test | Reverse | Max. | Peak Pulse |
|---------|----------|---------|------|------|----------------------------------|------|----------------|-----------|----------|------------|
| | | | | | V _{BR} @ I _T | | | | | |
| | | | | | Min | Max | I _T | IR @ VRWM | VC @ IPP | IPP |
| Uni | Bi | Uni | Bi | V | V | V | mA | μA | V | A |
| SMF5.0A | SMF5.0CA | AE | CAE | 5 | 6.4 | 7 | 10 | 400 | 9.2 | 21.7 |
| SMF6.0A | SMF6.0CA | AG | CAG | 6 | 6.67 | 7.37 | 10 | 400 | 10.3 | 19.4 |
| SMF6.5A | SMF6.5CA | AK | CAK | 6.5 | 7.22 | 7.98 | 10 | 250 | 11.2 | 17.9 |
| SMF7.0A | SMF7.0CA | AM | CAM | 7 | 7.78 | 8.6 | 10 | 100 | 12 | 16.7 |
| SMF7.5A | SMF7.5CA | AP | CAP | 7.5 | 8.33 | 9.21 | 1 | 50 | 12.9 | 15.5 |
| SMF8.0A | SMF8.0CA | AR | CAR | 8 | 8.89 | 9.83 | 1 | 25 | 13.6 | 14.7 |
| SMF8.5A | SMF8.5CA | AT | CAT | 8.5 | 9.44 | 10.4 | 1 | 10 | 14.4 | 13.9 |
| SMF9.0A | SMF9.0CA | AV | CAV | 9 | 10 | 11.1 | 1 | 5 | 15.4 | 13 |
| SMF10A | SMF10CA | AX | CAX | 10 | 11.1 | 12.3 | 1 | 2.5 | 17 | 11.8 |
| SMF11A | SMF11CA | AZ | CAZ | 11 | 12.2 | 13.5 | 1 | 2.5 | 18.2 | 11 |
| SMF12A | SMF12CA | BE | CBE | 12 | 13.3 | 14.7 | 1 | 2.5 | 19.9 | 10.1 |
| SMF13A | SMF13CA | BG | CBG | 13 | 14.4 | 15.9 | 1 | 1 | 21.5 | 9.3 |
| SMF14A | SMF14CA | BK | CBK | 14 | 15.6 | 17.2 | 1 | 1 | 23.2 | 8.6 |
| SMF15A | SMF15CA | BM | CBM | 15 | 16.7 | 18.5 | 1 | 1 | 24.4 | 8.2 |
| SMF16A | SMF16CA | BP | CBP | 16 | 17.8 | 19.7 | 1 | 1 | 26 | 7.7 |
| SMF17A | SMF17CA | BR | CBR | 17 | 18.9 | 20.9 | 1 | 1 | 27.6 | 7.2 |
| SMF18A | SMF18CA | BT | CBT | 18 | 20 | 22.1 | 1 | 1 | 29.2 | 6.8 |
| SMF20A | SMF20CA | BV | CBV | 20 | 22.2 | 24.5 | 1 | 1 | 32.4 | 6.2 |
| SMF22A | SMF22CA | BX | CBX | 22 | 24.4 | 26.9 | 1 | 1 | 35.5 | 5.6 |
| SMF24A | SMF24CA | BZ | CBZ | 24 | 26.7 | 29.5 | 1 | 1 | 38.9 | 5.1 |
| SMF26A | SMF26CA | CE | CCE | 26 | 28.9 | 31.9 | 1 | 1 | 42.1 | 4.8 |
| SMF28A | SMF28CA | CG | CCG | 28 | 31.1 | 34.4 | 1 | 1 | 45.4 | 4.4 |
| SMF30A | SMF30CA | CK | CCK | 30 | 33.3 | 36.8 | 1 | 1 | 48.4 | 4.1 |
| SMF33A | SMF33CA | CM | CCM | 33 | 36.7 | 40.6 | 1 | 1 | 53.3 | 3.8 |
| SMF36A | SMF36CA | CP | CCP | 36 | 40 | 44.2 | 1 | 1 | 58.1 | 3.4 |
| SMF40A | SMF40CA | CR | CCR | 40 | 44.4 | 49.1 | 1 | 1 | 64.5 | 3.1 |
| SMF43A | SMF43CA | CT | CCT | 43 | 47.8 | 52.8 | 1 | 1 | 69.4 | 2.9 |
| SMF45A | SMF45CA | CV | CCV | 45 | 50 | 55.3 | 1 | 1 | 72.7 | 2.8 |
| SMF48A | SMF48CA | CX | CCX | 48 | 53.3 | 58.9 | 1 | 1 | 77.4 | 2.6 |
| SMF51A | SMF51CA | CZ | CCZ | 51 | 56.7 | 62.7 | 1 | 1 | 82.4 | 2.4 |
| SMF54A | SMF54CA | DE | CDE | 54 | 60 | 66.3 | 1 | 1 | 87.1 | 2.3 |
| SMF58A | SMF58CA | DG | CDG | 58 | 64.4 | 71.2 | 1 | 1 | 93.6 | 2.1 |
| SMF60A | SMF60CA | DK | CDK | 60 | 66.7 | 73.7 | 1 | 1 | 96.8 | 1.8 |
| SMF64A | SMF64CA | DM | CDM | 64 | 71.1 | 78.6 | 1 | 1 | 103 | 1.7 |
| SMF70A | SMF70CA | DP | CDP | 70 | 77.8 | 86 | 1 | 1 | 113 | 1.5 |
| SMF75A | SMF75CA | DR | CDR | 75 | 83.3 | 92.1 | 1 | 1 | 121 | 1.4 |
| SMF78A | SMF78CA | DT | CDT | 78 | 86.7 | 95.8 | 1 | 1 | 126 | |
| SMF85A | SMF85CA | DV | CDV | 85 | 94.4 | 104 | 1 | 1 | 137 | 1.3 |
| SMF90A | SMF90CA | DX | CDX | 90 | 100 | 111 | 1 | 1 | 146 | 1.2 |
| SMF100A | SMF100CA | DZ | CDZ | 100 | 111 | 123 | 1 | 1 | 162 | 1.1 |
| SMF110A | SMF110CA | EE | CEE | 110 | 122 | 135 | 1 | 1 | 177 | 1 |
| SMF120A | SMF120CA | EG | CEG | 120 | 133 | 147 | 1 | 1 | 193 | 0.9 |
| SMF130A | SMF130CA | EK | CEK | 130 | 144 | 159 | 1 | 1 | 209 | 0.8 |
| SMF150A | SMF150CA | EM | CEM | 150 | 167 | 185 | 1 | 1 | 243 | 0.7 |
| SMF160A | SMF160CA | EP | CEP | 160 | 178 | 197 | 1 | 1 | 259 | |
| SMF170A | SMF170CA | ER | CER | 170 | 189 | 209 | 1 | 1 | 275 | 0.6 |
| SMF180A | SMF180CA | ET | CET | 180 | 201 | 222 | 1 | 1 | 292 | 0.5 |
| SMF190A | SMF190CA | EV | CEV | 190 | 211 | 232 | 1 | 1 | 308 | |
| SMF200A | SMF200CA | EX | CEX | 200 | 224 | 247 | 1 | 1 | 324 | |
| SMF220A | SMF220CA | E22 | CE22 | 220 | 246 | 272 | 1 | 1 | 356 | |
| SMF250A | SMF250CA | E25 | CE25 | 250 | 279 | 309 | 1 | 1 | 405 | |
| SMF300A | SMF300CA | E30 | CE30 | 300 | 335 | 371 | 1 | 1 | 486 | |
| SMF350A | SMF350CA | E35 | CE35 | 350 | 391 | 432 | 1 | 1 | 567 | 0.4 |
| SMF400A | SMF400CA | E40 | CE40 | 400 | 447 | 494 | 1 | 1 | 648 | 0.35 |
| SMF440A | SMF440CA | E44 | CE44 | 440 | 492 | 543 | 1 | 1 | 713 | 0.3 |

Fig.1 Peak Pulse Power Rating Curve

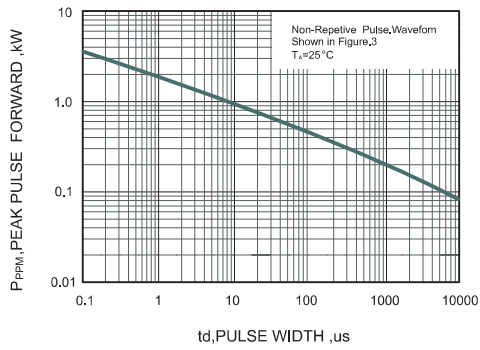

Fig.2 Forward Current Derating Curve

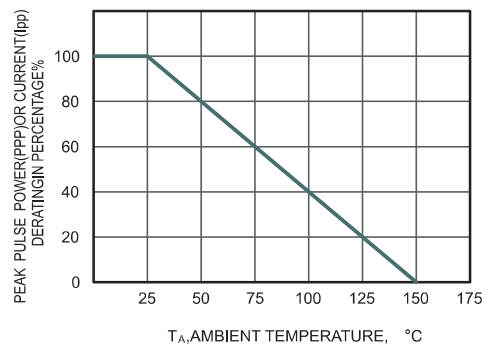

Fig.3 Pulse Waveform

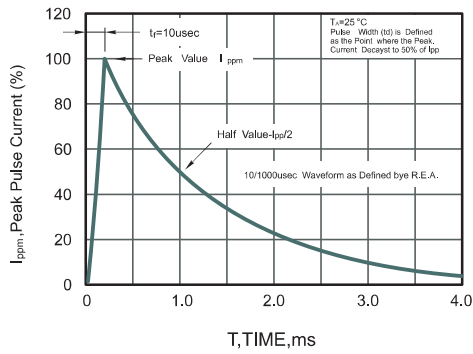
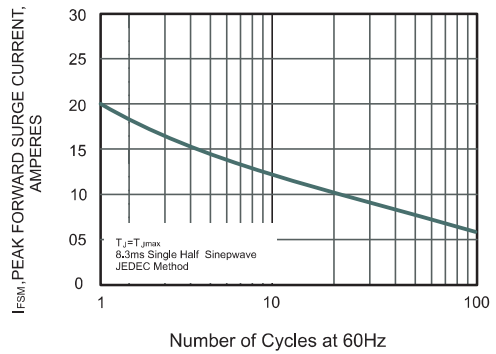
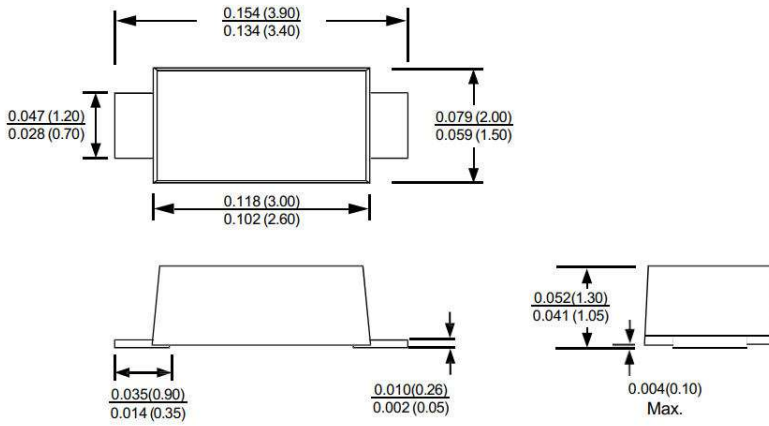

Fig.4 Maximum Non-Repetitive Peak Forward Surge Current



Package Outline

SOD-123FL



Mounting Pad Layout

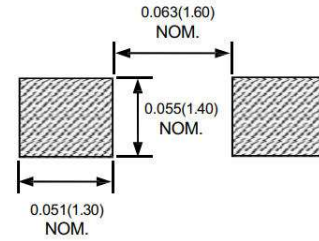

Summary of Packing Options

| Package | Packing Description | Packing Quantity | Industry Standard |
|-----------|---------------------|------------------|-------------------|
| SOD-123FL | Tape/Reel, 13" reel | 10000 | EIA-481-1 |
| | Tape/Reel, 7" reel | 3000 | EIA-481-1 |

单击下面可查看定价，库存，交付和生命周期等信息

[>>YFW\(佑风微\)](#)