

Surface Mount Fast Recovery Rectifiers

Reverse Voltage - 50 to 1000 V

Forward Current - 1 A

FEATURES

- ◆ Low forward voltage drop
- ◆ Low leakage current
- ◆ For surface mounted applications
- ◆ Low profile package
- ◆ Glass Passivated Chip Junction
- ◆ Lead free in comply with EU RoHS 2011/65/EU directives

MECHANICAL DATA

- ◆ Case: SOD-323
- ◆ Terminals: Solderable per MIL-STD-750, Method 2026
- ◆ Approx. Weight: 4.5mg / 0.00016oz

Absolute Maximum Ratings and characteristics

Ratings at 25 °C ambient temperature unless otherwise specified.
Single phase half-wave 60 Hz, resistive or inductive load, for capacitive load current derate by 20 %.

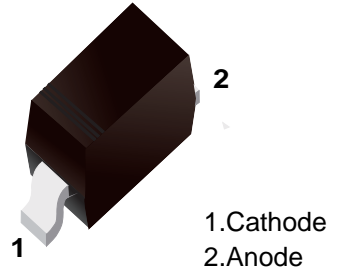

■ Simplified outline(SOD-323)

Top View

| Marking Code | |
|--------------|----|
| FR101WS | 1R |
| FR102WS | 2R |
| FR103WS | 3R |
| FR104WS | 4R |
| FR105WS | 5R |
| FR106WS | 6R |
| FR107WS | 7R |

| Parameter | Symbols | FR101WS | FR102WS | FR103WS | FR104WS | FR105WS | FR106WS | FR107WS | Units |
|--|-----------------|------------|---------|---------|---------|---------|---------|---------|--------------------|
| Maximum Repetitive Peak Reverse Voltage | V_{RRM} | 50 | 100 | 200 | 400 | 600 | 800 | 1000 | V |
| Maximum RMS voltage | V_{RMS} | 35 | 70 | 140 | 280 | 420 | 560 | 700 | V |
| Maximum DC Blocking Voltage | V_{DC} | 50 | 100 | 200 | 400 | 600 | 800 | 1000 | V |
| Maximum Average Forward Rectified Current at $T_c = 125\text{ }^\circ\text{C}$ | $I_{F(AV)}$ | 1 | | | | | | | A |
| Peak Forward Surge Current 8.3 ms Single Half Sine Wave Superimposed on Rated Load | I_{FSM} | 25 | | | | | | | A |
| Maximum Instantaneous Forward Voltage at 1 A | V_F | 1.3 | | | | | | | V |
| Maximum DC Reverse Current $T_a = 25\text{ }^\circ\text{C}$ at Rated DC Blocking Voltage $T_a = 125\text{ }^\circ\text{C}$ | I_R | 5 50 | | | | | | | μA |
| Typical Junction Capacitance at $V_R = 4\text{V}, f = 1\text{MHz}$ | C_j | 5 | | | | | | | pF |
| Maximum Reverse Recovery Time ⁽¹⁾ | T_{rr} | 150 | | | | 250 | 500 | | nS |
| Typical Thermal Resistance ⁽²⁾ | $R_{\theta JA}$ | 85 | | | | | | | $^\circ\text{C/W}$ |
| Operating and Storage Temperature Range | T_j, T_{stg} | -55 ~ +150 | | | | | | | $^\circ\text{C}$ |

(1) Measured with $I_F = 0.5\text{A}, I_R = 1\text{A}, I_n = 0.25\text{A}$

(2) P.C.B. mounted with 2.0" X 2.0" (5 X 5 cm) copper pad areas.

Fig.1 Forward Current Derating Curve

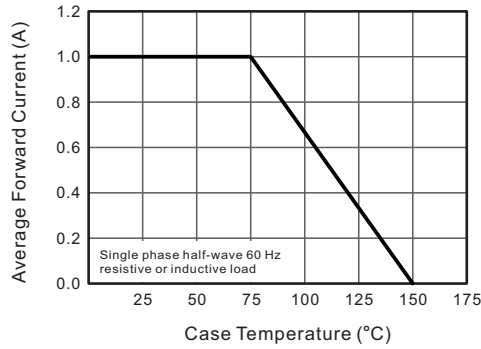

Fig.2 Typical Instantaneous Reverse Characteristics

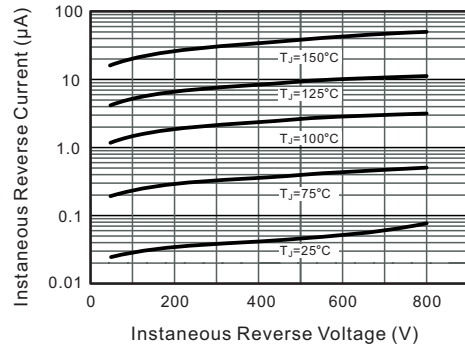

Fig.3 Typical Forward Characteristic

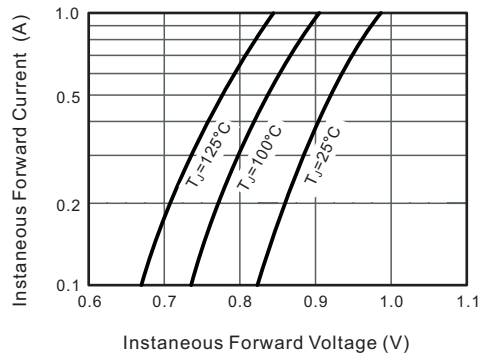

Fig.4 Typical Junction Capacitance

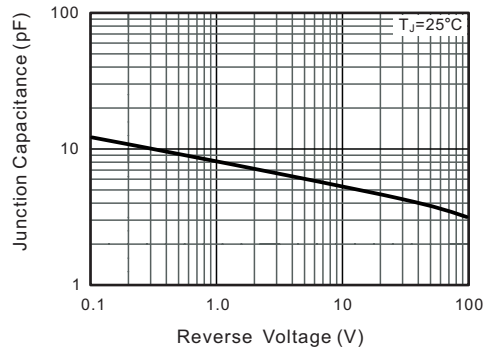
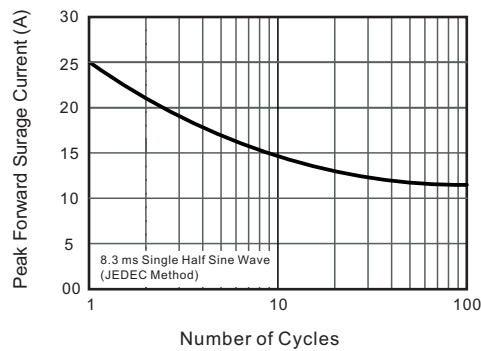
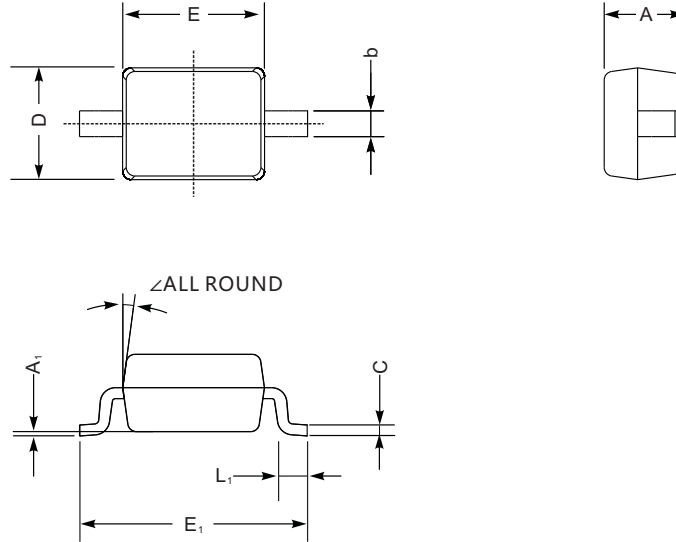

Fig.5 Maximum Non-Repetitive Peak Forward Surge Current



Package Outline SOD-323

Plastic surface mounted package; 2 leads



| UNIT | | A | C | D | E | E ₁ | b | L ₁ | A ₁ | ∠ |
|------|-----|-----|------|-----|-----|----------------|------|----------------|----------------|----|
| mm | max | 1.1 | 0.15 | 1.4 | 1.8 | 2.75 | 0.4 | 0.45 | 0.2 | 9° |
| | min | 0.8 | 0.08 | 1.2 | 1.4 | 2.55 | 0.25 | 0.2 | — | |
| mil | max | 43 | 5.9 | 55 | 70 | 108 | 16 | 16 | 8 | |
| | min | 32 | 3.1 | 47 | 63 | 100 | 9.8 | 7.9 | — | |

The recommended mounting pad size

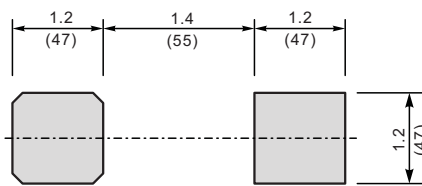

Unit: $\frac{\text{mm}}{\text{mil}}$

Summary of Packing Options

| Package | Packing Description | Packing Quantity | Industry Standard |
|---------|---------------------|------------------|-------------------|
| SOD-323 | Tape/Reel, 7" reel | 3000 | EIA-481-1 |

单击下面可查看定价，库存，交付和生命周期等信息

[>>YFW\(佑风微\)](#)