

16A 4Quadrants TRIACs

Product Summary

Symbol	Value	Unit
$I_{T(AV)}$	16	A
$V_{DRM} V_{RRM}$	600/800	V
V_{TM}	1.55	V

Features

With high ability to withstand the shock loading of arge current, Provide high dv/dt rate with strong resistance to electromagnetic interference

Application

Power charger, T-tools, massager, solid staterelay, AC Motor speed regulation and so on.

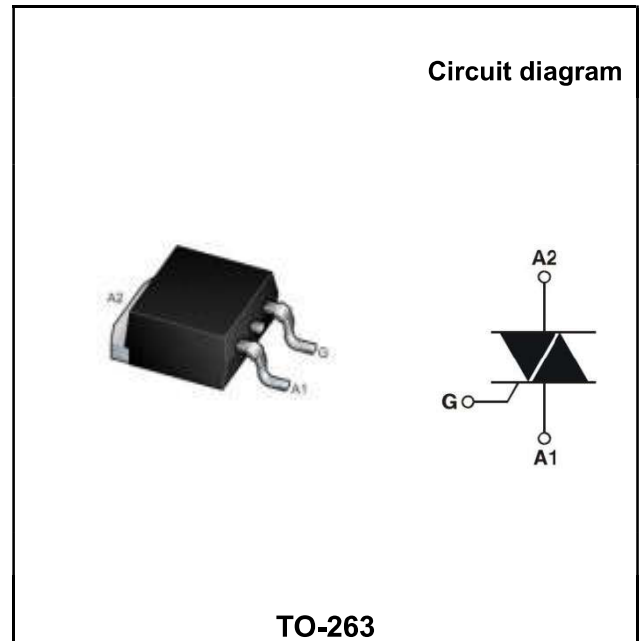

Order Information

Part Number	Package	Marking	packing	packing Quantity
BT139Q	TO-263	BT139 600E XXXX	Tape	800PCS/Reel

Absolute maximum ratings (Ta=25°C unless otherwise noted)

Parameter	Symbol	Value	Unit
Repetitive peak off-state voltage	V_{DRM}	600/800	V
Repetitive peak reverse voltage	V_{RRM}	600/800	V
RMS on-state current	$I_{T(RMS)}$	16	A
Non repetitive surge peak on-state current (full cycle, F=50Hz)	I_{TSM}	140	A
I^2t value for fusing (tp=10ms)	I^2t	98	A ² s
Critical rate of rise of on-state current ($I_G = 2 \times I_{GT}$)	di/dt	I - II -III	50
		IV	10
Peak gate current	I_{GM}	2	A
Gate peak power	I_{GM}	5	W
Average gate power dissipation	$P_G(AV)$	0.5	W
Junction Temperature	T_J	-40~+125	°C
Storage Temperature	T_{STG}	-40 ~+150	°C

Electrical characteristics (TA=25°C, unless otherwise noted)

Parameter	Symbol	Test Condition	Value			Unit	
			D	E	F		
Gate trigger current	I_{GT}	$V_D=12V$, $I_T=0.1A$, $T_j=25^\circ C$, Fig.6	I - II -III	≤ 5	≤ 10	≤ 25	mA
			IV	≤ 10	≤ 25	≤ 70	
Gate trigger voltage	V_{GT}		I - II -III-IV	≤ 1.3			V
Gate non-trigger voltage	V_{GD}	$V_D=V_{DRM}$, $T_j=125^\circ C$	≥ 0.2			V	
Holding current	I_H	$V_D=12V$, $I_{GT}=0.1A$, $T_j=25^\circ C$, Fig.6	I - II -III-IV	≤ 10	≤ 25	≤ 30	mA
Latching current	I_L		I -III-IV	≤ 15	≤ 30	≤ 40	mA
			II	≤ 20	≤ 40	≤ 70	mA
Critical-rate of rise of commutation voltage	dV_D/dt	$V_D=67\%_{DRM}$, $T_j=125^\circ C$	≥ 10	≥ 20	≥ 50	V/us	

STATIC CHARACTERISTICS

Forward "on" voltage	V_{TM}	$I_{TM}=20A$, $t_p=380us$, Fig.4	≤ 1.55			V	
Repetitive Peak Off-State Current	I_{DRM}	$V_D=V_{DRM}$ $V_R=V_{RRM}$	$T_j=25^\circ C$	≤ 10	≤ 10	≤ 10	uA
Repetitive Peak Reverse Current	I_{RRM}		$T_j=125^\circ C$	≤ 1	≤ 1	≤ 1	mA

THERMAL RESISTANCES

Thermal resistance	$R_{th(j-c)}$	Junction to case(AC)	TYP.	1.2	$^\circ C/W$
	$R_{th(j-a)}$	Junction to ambient	TYP.	45	$^\circ C/W$

Ordering Information

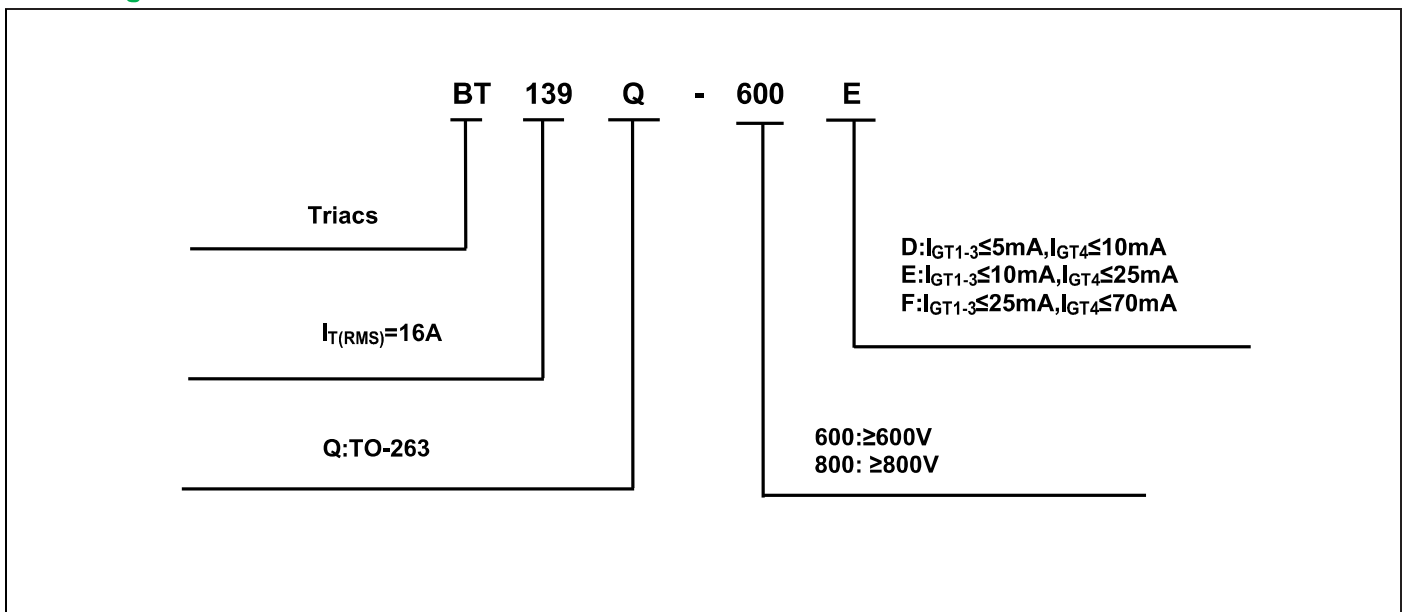

Typical Characteristics

FIG.1: Maximum power dissipation versus RMS on-state current (full cycle)

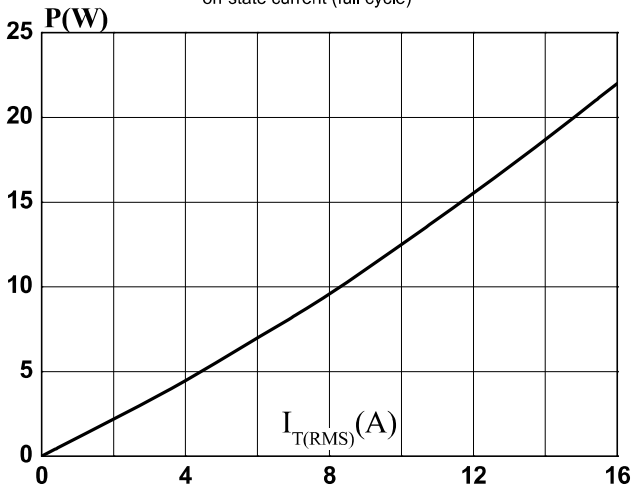

FIG.2: RMS on-state current versus case temperature (full cycle)

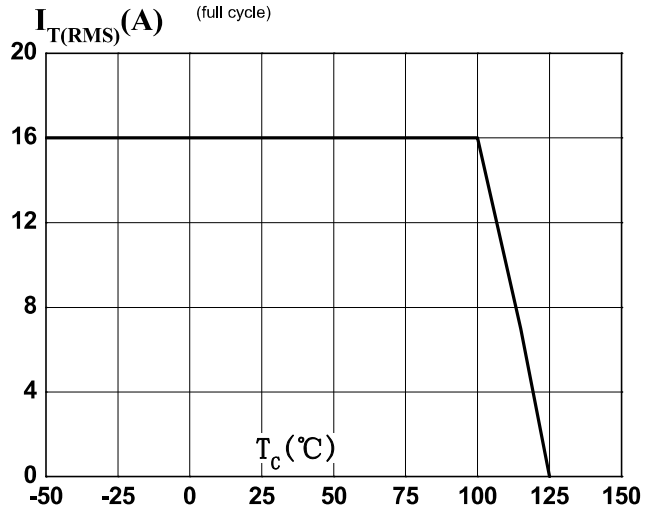

FIG.3: Surge peak on-state current versus number of cycles

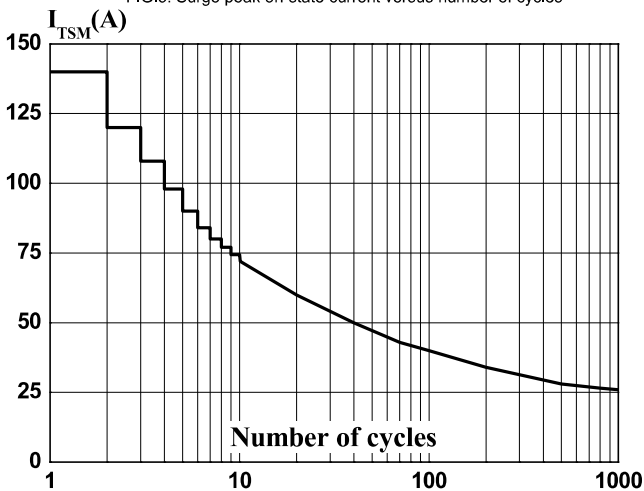

FIG.4: On-state characteristics (maximum values)

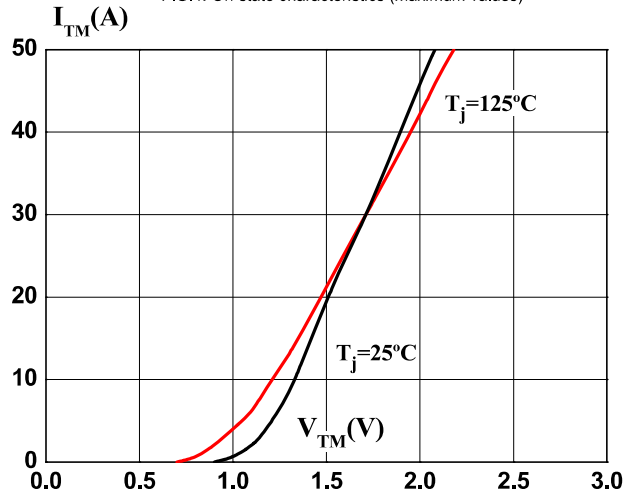

FIG.5: Non-repetitive surge peak on-state current for a sinusoidal pulse with width $t_p < 10ms$

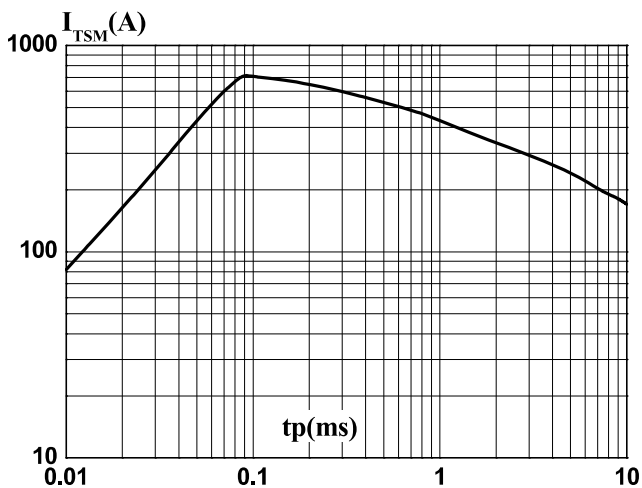
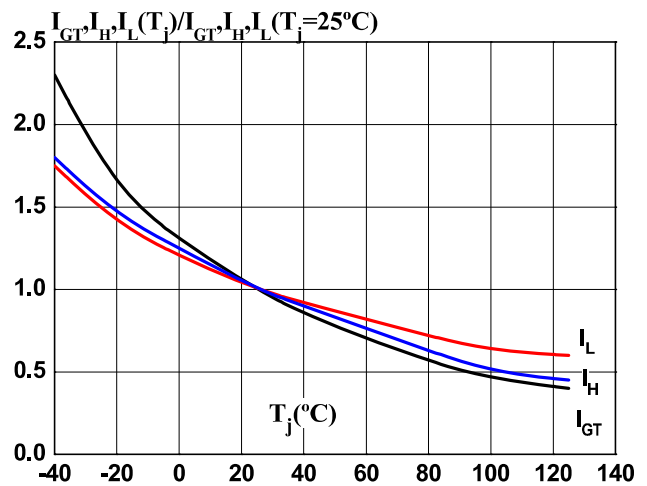
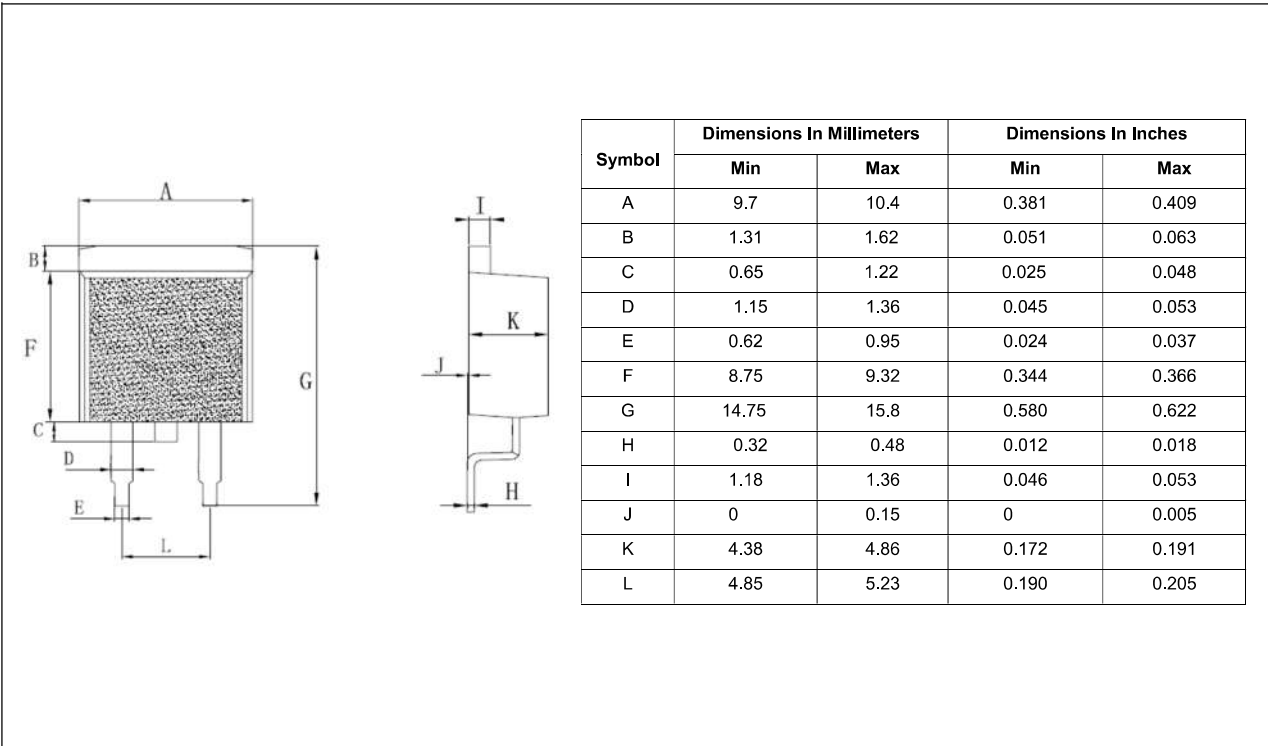

FIG.6: Relative variations of gate trigger current, holding current and latching current versus junction temperature (typical values)



TO-263



单击下面可查看定价，库存，交付和生命周期等信息

[>>YFW\(佑风微\)](#)