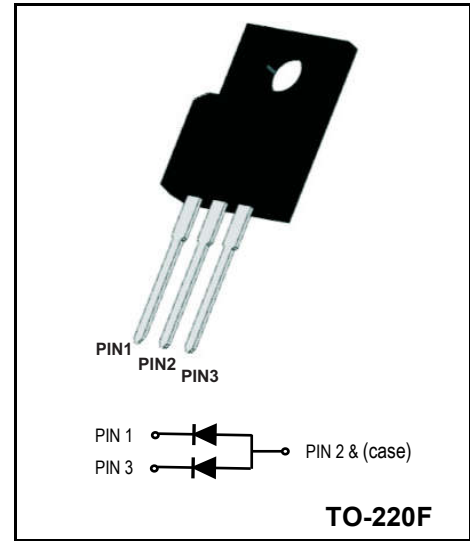

Super Fast Rectifiers
Reverse Voltage - 600V
Forward Current - 20A
FEATURES

- Glass passivated chip junctions
- Super fast recovery time for switching mode application
- High Forward Surge Capability
- Low Reverse Current
- Lead free in compliance with EU RoHS 2011/65/EU directive

MECHANICAL DATA

- Circuit figure: Common Anode
- Leads: Solderable per mil-std-202, Method 208
- Polarity: as marked
- Mounting torque: 5 in-lbs maximum
- Terminals: Puretin plated
- Weight: TO-220F 1.70 grams

MAXIMUM RATINGS AND ELECTRICAL CHARACTERISTICS (TA=25°C)

RATINGS	SYMBOL	Value	Units
Maximum repetitive reverse voltage	V_{RRM}	600	V
Maximum RMS voltage	V_{RMS}	420	V
Maximum DC blocking voltage	V_{DC}	600	V
Maximum average forward current	I_{AV}	20	A
Peak forward surge current, 8.3ms single half sine-wave superimposed on rated load	I_{FSM}	300	A
Typical thermal resistance per diode (Note 1)	$R_{\theta-JC}$	4.0	°C/W
Operation Junction Temperature and Storage Temperature	T_J, T_{STG}	-55 ~ +150	°C
CHARACTERISTICS			
Typical forward voltage per leg at 10A	V_F	1.65	V
Maximum average reverse current at rated DC blocking voltage	I_R	5 250	μA
Typical reverse recovery time (Note 2)	T_{RR}	35	nS

Notes: 1. Thermal resistance from junction to case.
 2. Test conditions: $I_F=0.5A$, $I_R=1.0A$, $I_{RR}=0.25A$.

Ratings And Characteristic Curves

FIG. 1 - TYPICAL FORWARD CURRENT DERATING CURVE

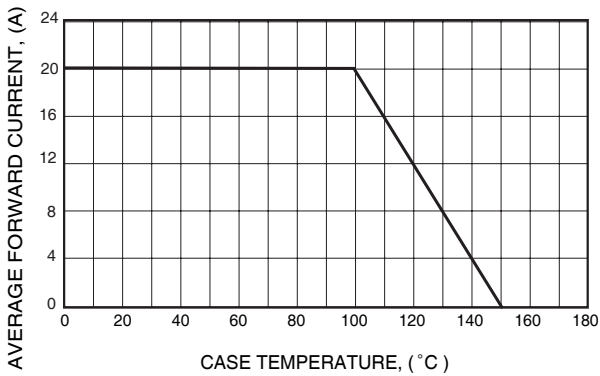

FIG. 3 - MAXIMUM NON-REPETITIVE FORWARD SURGE CURRENT

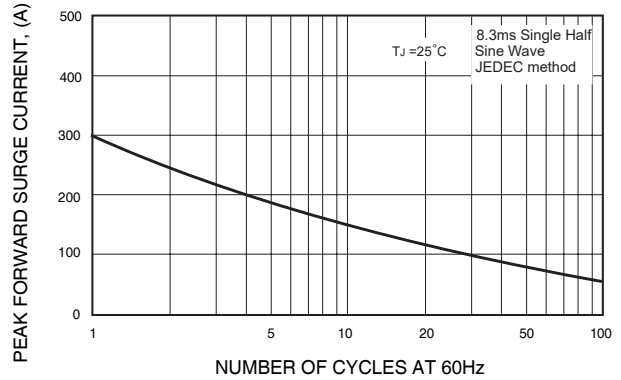

FIG. 4 - TYPICAL REVERSE CHARACTERISTICS

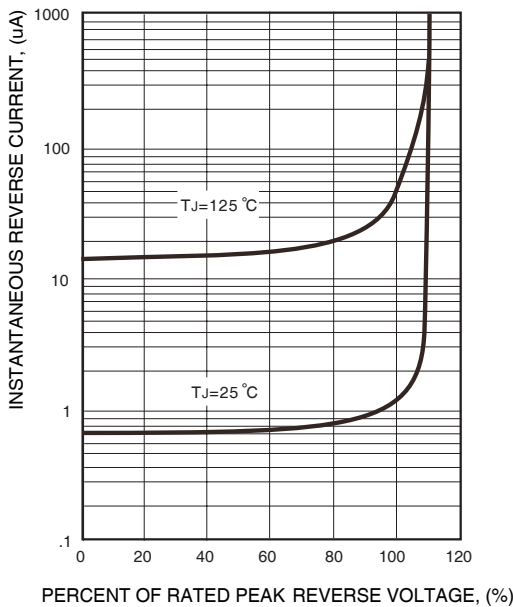

FIG. 2 - TYPICAL INSTANTANEOUS FORWARD CHARACTERISTICS

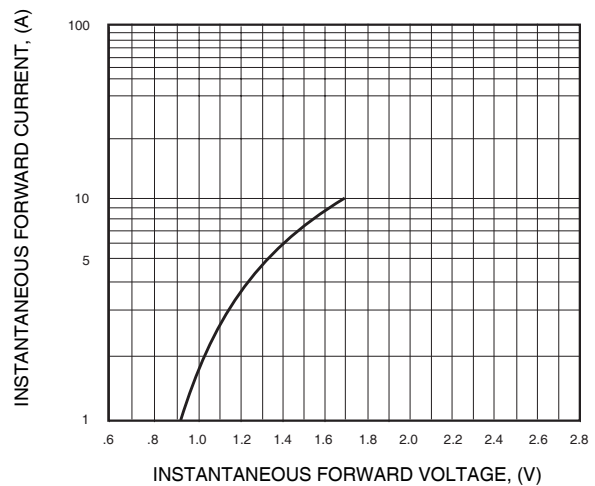
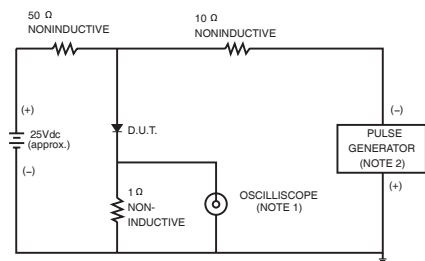
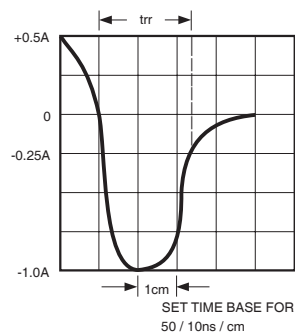

FIG. 6- TEST CIRCUIT DIAGRAM AND REVERSE RECOVERY TIME CHARACTERISTICS



NOTES: 1. Rise Time= 7ns max., Input Impedance= 1 megohm, 22pF.
2. Rise Time= 10ns max., Source Impedance= 50 ohms.



Package Outline Dimensions Millimeters

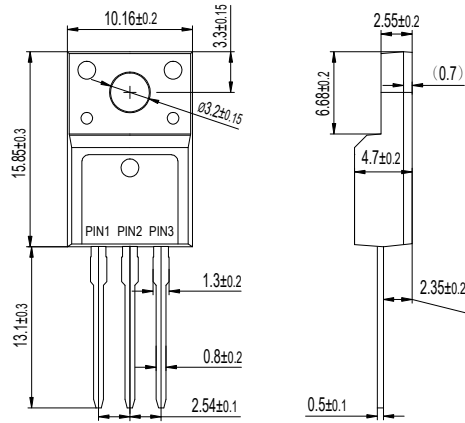

单击下面可查看定价，库存，交付和生命周期等信息

[>>YFW\(佑风微\)](#)