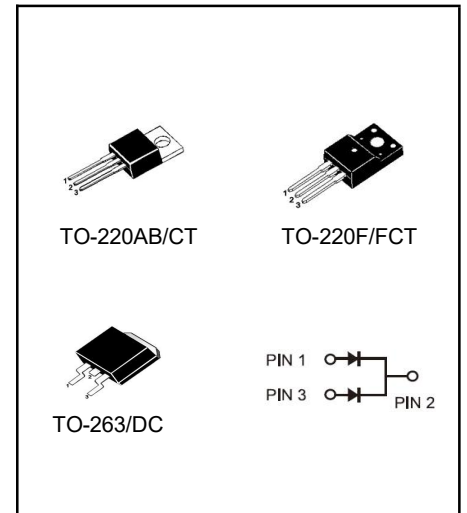

LOW VF SCHOTTKY RECTIFIER
Reverse Voltage - 300 V
Forward Current - 20A
FEATURES

- Low forward voltage
- High current capability
- High forward surge capability
- Low power losses, High efficiency
- Guarding for over voltage protection

MECHANICAL DATA

- Case: Molded plastic
- Polarity: As marked
- Mounting Position: Any
- Molded Plastic: UL Flammability Classification Rating 94V-0
- Lead free in compliance with EU RoHS 2011/65/EU directive
- Solder bath temperature 275°C maximum, 10s per JESD 22-B106

Primary Characteristic

I_o	2*10A
V_{RRM}	300V
I_{FSM}	180A
V_F	0.78V
$T_J \text{ Max}$	150°C

Maximum Ratings (Per Leg) at Ta=25°C unless otherwise specified

Characteristics		Symbol	Value	Unit
Maximum Repetitive Peak Reverse Voltage		V_{RRM}	300	V
Working Peak Reverse Voltage		V_{RWM}	210	V
Maximum DC Blocking Voltage		V_{DC}	300	V
Maximum Average Forward Rectified Current	Per Leg	I_o	10	A
	Total		20	
Peak Forward Surge Current, 8.3 ms Single Half Sine-wave Superimposed on Rated Load (JEDEC method)		I_{FSM}	180	A
Operating Temperature Range		T_J	-50 to +150	°C
Storage Temperature Range		T_{STG}	-50 to +150	°C
Typical Thermal Resistance (Note1)		$R_{\theta JC}$	2	°C/W
TO-220AB, TO-263				
TO-220F				

Note1: Thermal resistance from Junction to case per leg mounted on heatsink.

Electrical Characteristics (Per Leg) unless otherwise specified

Characteristics		Symbol	Value		Unit
Forward Voltage Drop(Note2)		V_F	Typ.	Max.	V
at $I_F=3A$	TA=25°C		0.77	0.83	
	TA=125°C		0.65	-	
at $I_F=5A$	TA=25°C		0.82	-	
	TA=125°C		0.69	-	
at $I_F=10A$	TA=25°C		0.92	0.98	
	TA=125°C		0.78	-	
Maximum Reverse Current at $V_R=300V$	TA=25°C		I_R	0.2	
	TA=125°C	20		-	μA

Note2: Pulse test: 300 μs pulse width, 1 % duty cycle

RATINGS AND CHARACTERISTIC CURVES

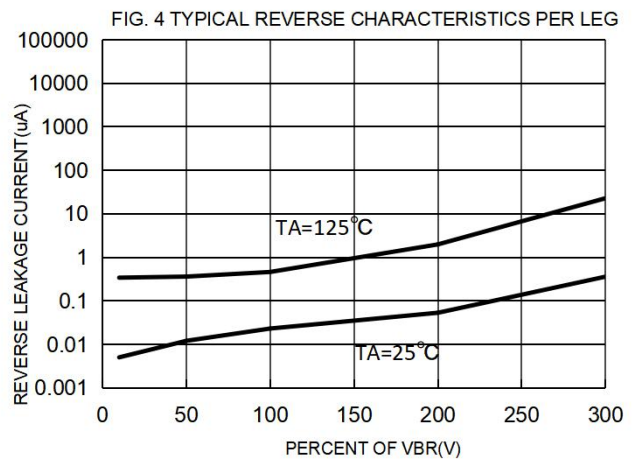
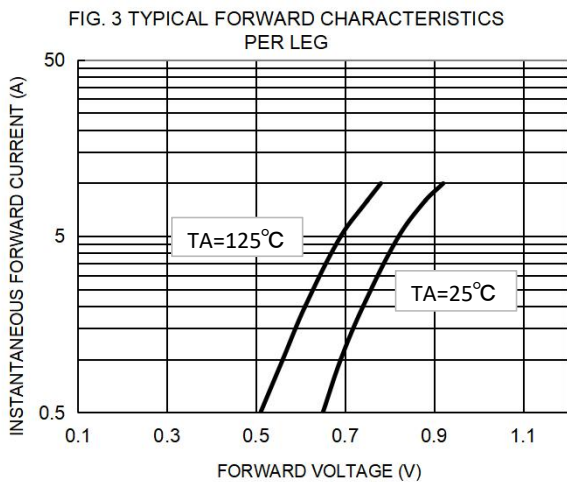
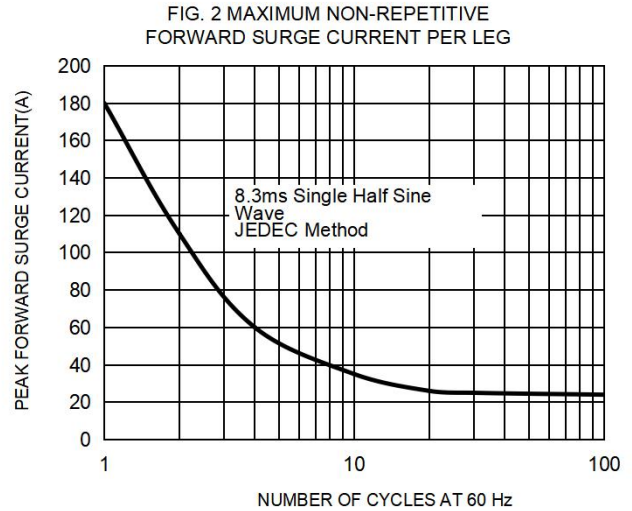
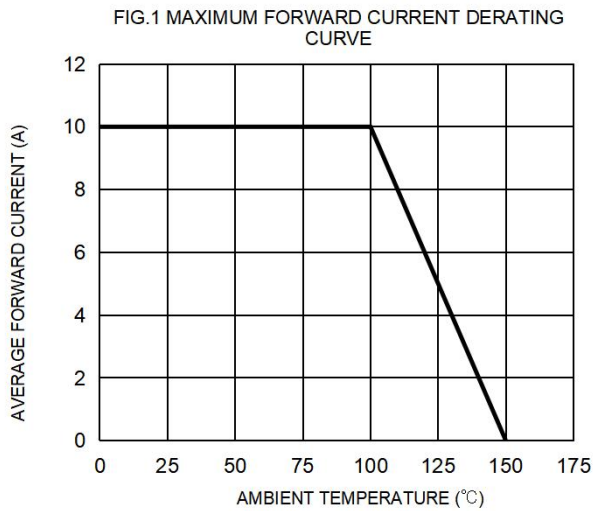

Marking on the body

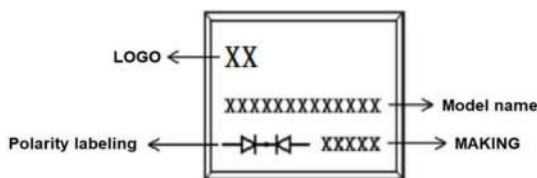

MAKING:

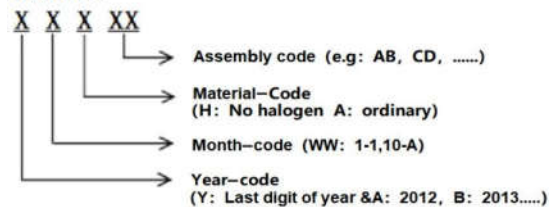

Ordering information

Part Number	Package	Unit Weight	Base Quantity	Delivery mode
SRM20L300CT	TO-220AB	0.07oz(1.96g)	50 pcs / tube	1000pcs/box 5000pcs/carton
SRM20L300FCT	TO-220F	0.06oz(1.74g)	50 pcs / tube	1000pcs/box 5000pcs/carton
SRM20L300DC	TO-263	0.04oz(1.16g)	800 pcs / reel	1600pcs/box 8000pcs/carton

Note: For Halogen Free molding compound, add "H" suffix to part number above.

Package Outline Dimensions millimeters

TO-220AB

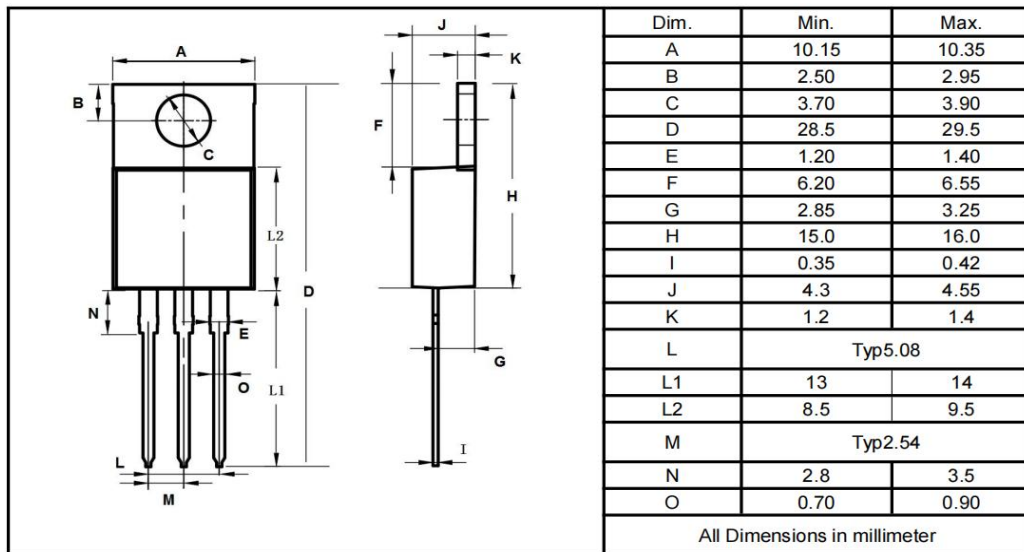

TO-220F

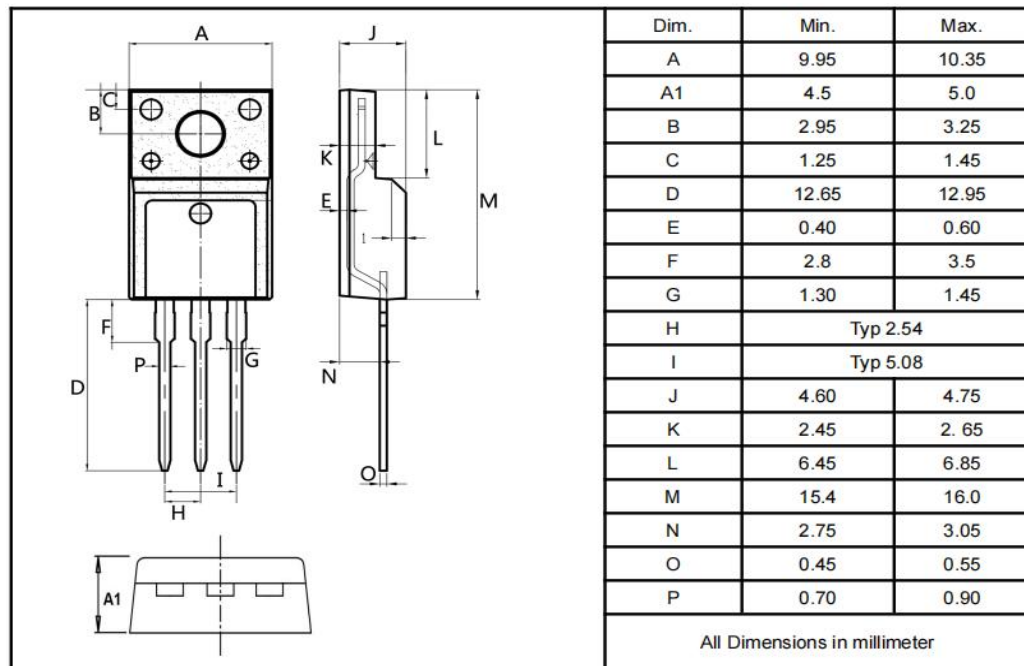

TO-263

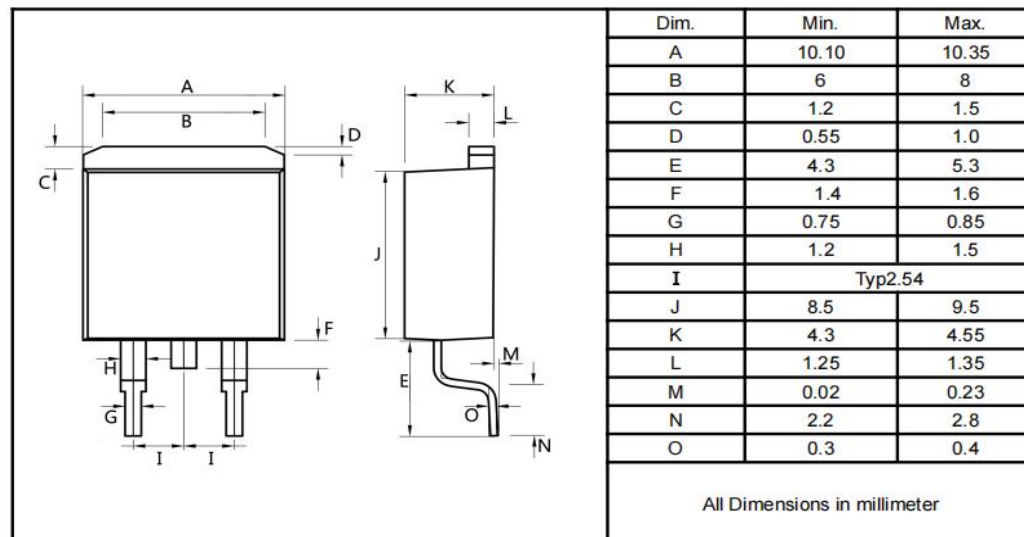

单击下面可查看定价，库存，交付和生命周期等信息

[>>YFW\(佑风微\)](#)