

**Silicon Planar Zener Diodes**

**FEATURES**

- ◆ Total power dissipation: Max. 500mW.
- ◆ Wide zener reverse voltage range 2.0 V to 75 V.
- ◆ Small plastic package suitable for surface mounted design.
- ◆ Tolerance approximately ± 2%.
- ◆ Lead free in comply with EU RoHS 2011/65/EU directives

**MECHANICAL DATA**

- ◆ Case: SOD-123
- ◆ Terminals: Solderable per MIL-STD-750, Method 2026
- ◆ Approx. Weight: 15mg / 0.00048oz

**Pinning**

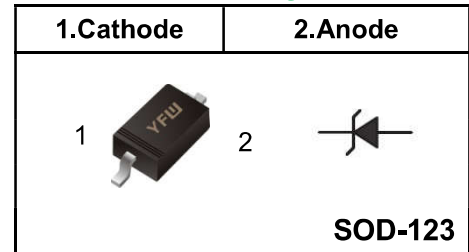

**Absolute Maximum Ratings And Characteristics (Ta = 25 °C)**

Parameter	Symbol	Value	Unit
Power Dissipation (Note 1)	<b>P<sub>D</sub></b>	500	mW
Forward Voltage (Note 2) at IF = 10 mA	<b>V<sub>F</sub></b>	0.9	V
Thermal Resistance from Junction to Ambient	<b>R<sub>θJA</sub></b>	340	°C/W
Junction Temperature	<b>T<sub>j</sub></b>	150	°C
Storage Temperature Range	<b>T<sub>stg</sub></b>	-55 ~ +150	°C

(1) Thermal resistance from junction to ambient at P.C.B. mounted with 2.0" X 2.0" (5 X 5 cm) copper areas pads.

(2) Short duration test pulse used to minimize self-heating effect

(3) f = 1kHz

**ELECTRICAL CHARACTERISTICS @ Ta=25°C unless otherwise specified**

Type	Marking	Zener Voltage Range <sup>(1)</sup>			I <sub>ZT</sub> (mA)	Dynamic Impedance	Reverse Current	
		V <sub>ZT</sub> ( at I <sub>ZT</sub> )				Z <sub>ZT</sub> ( at I <sub>ZT</sub> )	I <sub>R</sub>	at V <sub>R</sub>
		Min (V)	Nom ( V)	Max (V)		Max (Ω)	Max (μA)	(V)
BZT52B2V0	A4	1.96	2	2.04	5	100	120	0.5
BZT52B2V2	B4	2.16	2.2	2.24	5	100	120	0.7
BZT52B2V4	C4	2.35	2.4	2.45	5	100	120	1
BZT52B2V7	D4	2.65	2.7	2.75	5	110	120	1
BZT52B3V0	E4	2.94	3	3.06	5	120	50	1
BZT52B3V3	F4	3.23	3.3	3.37	5	130	20	1
BZT52B3V6	H4	3.53	3.6	3.67	5	130	10	1
BZT52B3V9	J4	3.82	3.9	3.98	5	130	5	1
BZT52B4V3	K4	4.21	4.3	4.39	5	130	5	1
BZT52B4V7	M4	4.61	4.7	4.79	5	130	2	1
BZT52B5V1	N4	5	5.1	5.20	5	130	2	1.5
BZT52B5V6	P4	5.49	5.6	5.71	5	80	1	2.5
BZT52B6V2	R4	6.08	6.2	6.32	5	50	1	3
BZT52B6V8	X4	6.66	6.8	6.94	5	30	0.5	3.5
BZT52B7V5	Y4	7.35	7.5	7.65	5	30	0.5	4
BZT52B8V2	Z4	8.04	8.2	8.36	5	30	0.5	5
BZT52B9V1	A5	8.92	9.1	9.28	5	30	0.5	6
BZT52B10	B5	9.8	10	10.2	5	30	0.1	7
BZT52B11	C5	10.78	11	11.22	5	30	0.1	8
BZT52B12	D5	11.76	12	12.24	5	35	0.1	9
BZT52B13	E5	12.74	13	13.26	5	35	0.1	10
BZT52B15	F5	14.7	15	15.3	5	40	0.1	11
BZT52B16	H5	15.68	16	16.32	5	40	0.1	12
BZT52B18	J5	17.64	18	18.36	5	45	0.1	13
BZT52B20	K5	19.6	20	20.4	5	50	0.1	15
BZT52B22	M5	21.56	22	22.44	5	55	0.1	17
BZT52B24	N5	23.52	24	24.48	5	60	0.1	19
BZT52B27	P5	26.46	27	27.54	5	70	0.1	21
BZT52B30	R5	29.4	30	30.6	5	80	0.1	23
BZT52B33	2WR	32.34	33	33.66	5	80	0.1	25
BZT52B36	Y5	35.28	36	36.72	5	90	0.1	27
BZT52B39	Z5	38.22	39	39.78	2.5	100	2	30
BZT52B43	A6	42.14	43	43.86	2.5	130	2	33
BZT52B47	B6	46.06	47	47.94	2.5	150	2	36
BZT52B51	C6	49.98	51	52.02	2.5	180	1	39
BZT52B56	D6	54.88	56	57.12	2.5	180	1	43
BZT52B62	E6	60.76	62	63.24	2.5	200	0.2	47
BZT52B68	F6	66.64	68	69.36	2.5	250	0.2	52
BZT52B75	H6	73.5	75	76.5	2.5	300	0.2	57

(1) V<sub>ZT</sub> is tested with pulses (20 ms)

Typical Characteristics

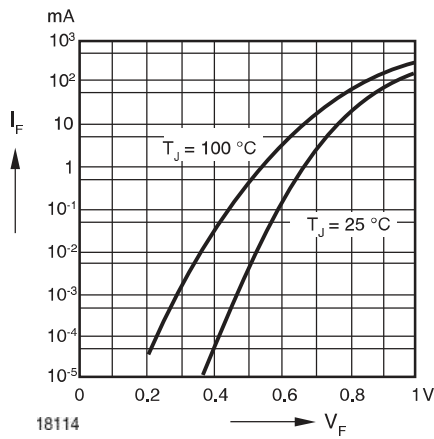

Fig. 1 - Forward characteristics

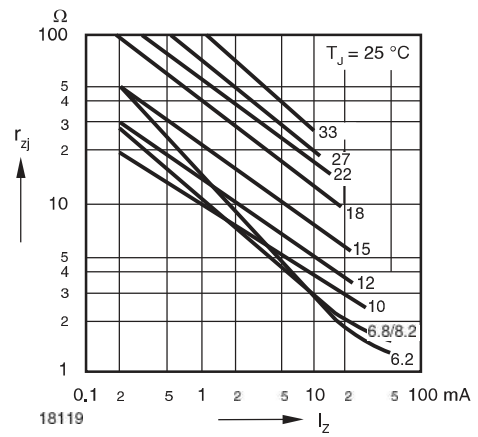

Fig. 4 - Dynamic Resistance vs. Zener Current

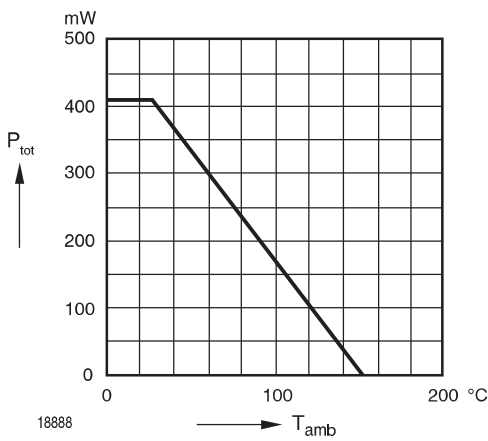

Fig. 2 - Admissible Power Dissipation vs. Ambient Temperature

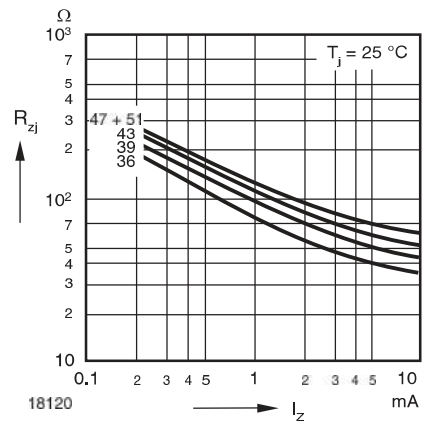

Fig. 5 - Dynamic Resistance vs. Zener Current

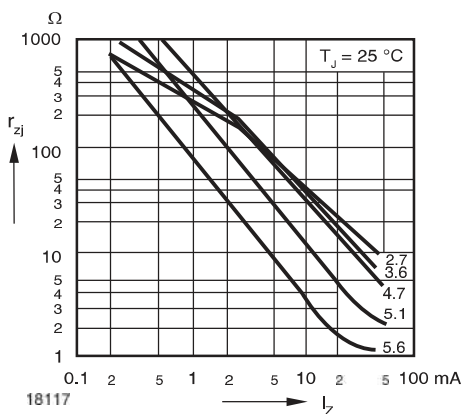

Fig. 3 - Dynamic Resistance vs. Zener Current

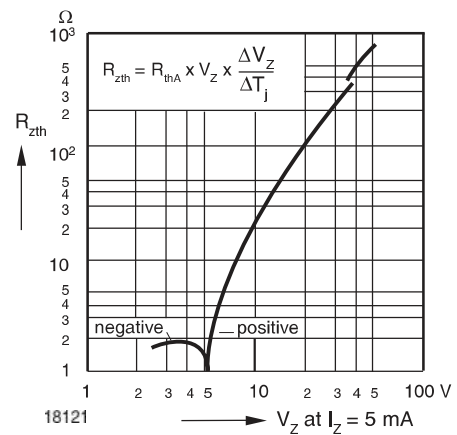

Fig. 6 - Thermal Differential Resistance vs. Zener Voltage

Typical Characteristics

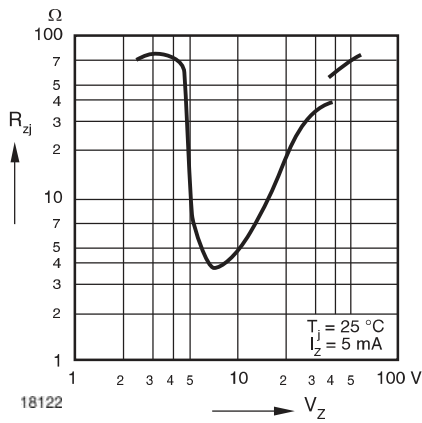

Fig. 7 - Dynamic Resistance vs. Zener Voltage

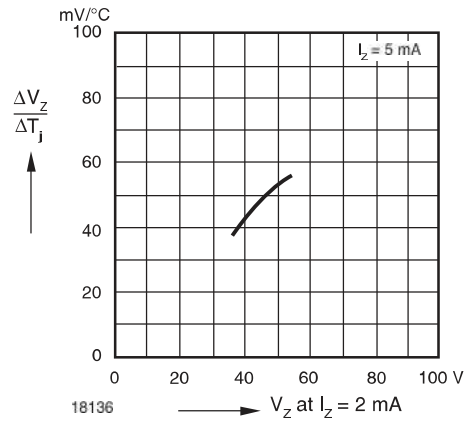

Fig. 10 - Temperature Dependence of Zener Voltage vs. Zener Voltage

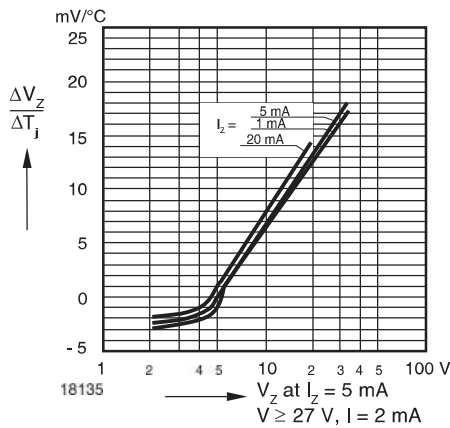

Fig. 8 - Temperature Dependence of Zener Voltage vs. Zener Voltage

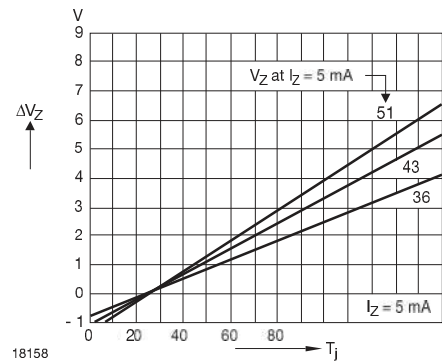

Fig. 11 - Change of Zener Voltage vs. Junction Temperature

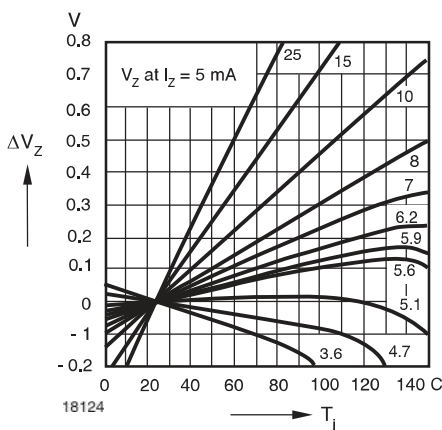

Fig. 9 - Change of Zener Voltage vs. Junction Temperature

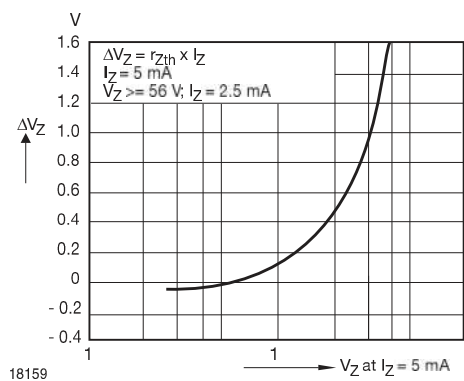

Fig. 12 - Change of Zener Voltage from Turn-on up to the Point of Thermal Equilibrium vs. Zener Voltage

Typical Characteristics

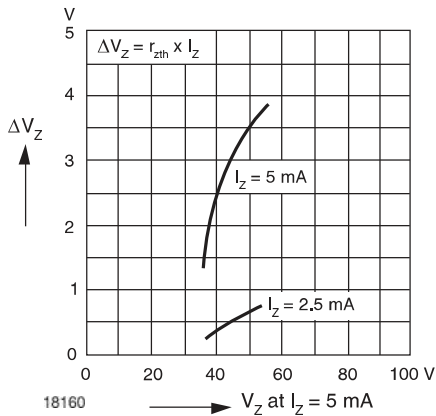

Fig. 13 - Change of Zener Voltage from Turn-on up to the Point of Thermal Equilibrium vs. Zener Voltage

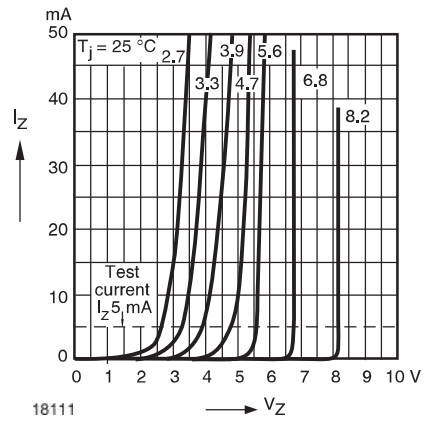

Fig. 14 - Breakdown Characteristics

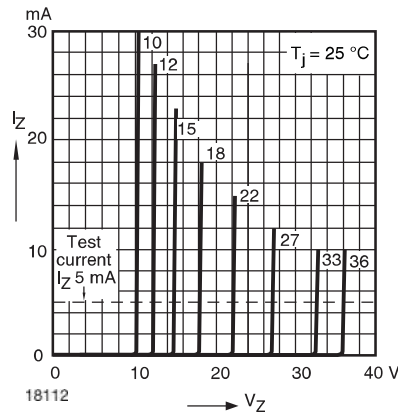

Fig. 15 - Breakdown Characteristics

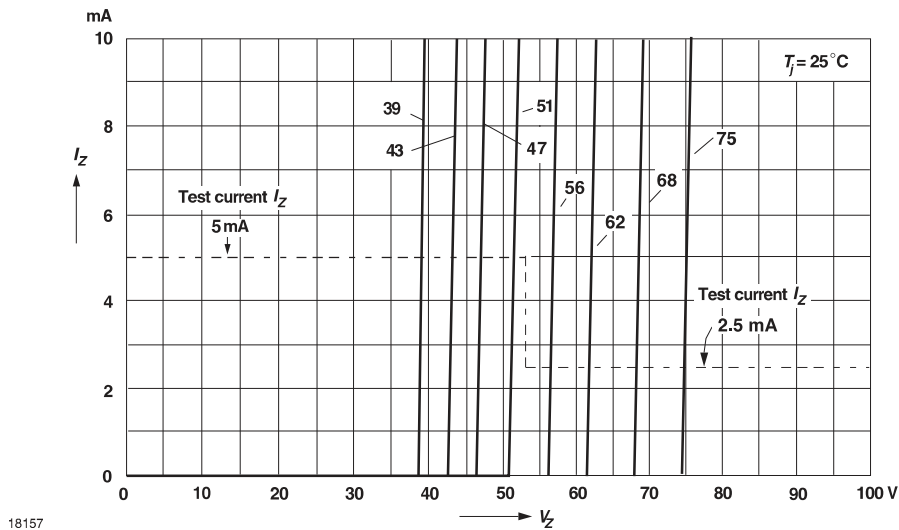
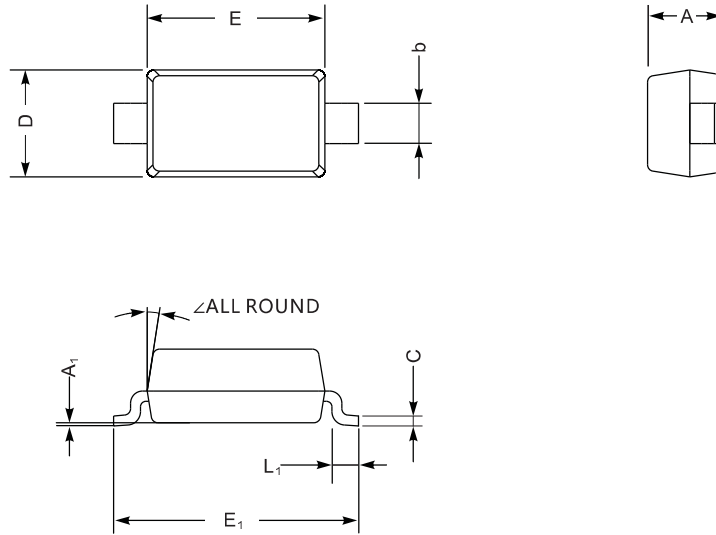

Fig. 16 - Breakdown Characteristics

The curve above is for reference only.

**Package Outline SOD-123**

Plastic surface mounted package; 2 leads



UNIT		A	C	D	E	E <sub>1</sub>	L <sub>1</sub>	b	A <sub>1</sub>	∠
mm	max	1.3	0.22	1.8	2.8	3.9	0.45	0.7	0.2	9°
	min	0.9	0.09	1.5	2.5	3.6	0.25	0.5	—	
mil	max	51	8.7	71	110	154	18	28	8	
	min	35	3.5	59	98	142	10	20	—	

**The recommended mounting pad size**

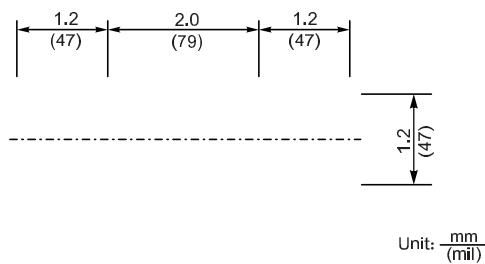

**Summary of Packing Options**

Package	Packing Description	Packing Quantity	Industry Standard
SOD-123	Tape/Reel, 7" reel	3000	EIA-481-1

单击下面可查看定价，库存，交付和生命周期等信息

[>>YFW\(佑风微\)](#)