

**3-terminal 5V 1.0A positive voltage regulator**

**Features**

- ◆ Output Current up to 1.0A
- ◆ Output Voltages of 5V
- ◆ Thermal Overload Protection
- ◆ Short Circuit Protection
- ◆ Output Transistor Safe Operating area (SOA)Protection

**Description**

The 78M05AS three-terminal positive regulators are available in the TO-263 package with several fixed output voltages making it useful in a wide range of applications.

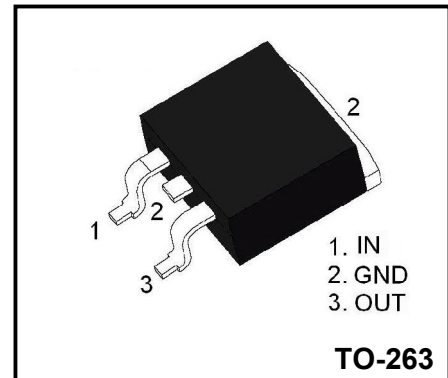

**Internal Block Diagram**

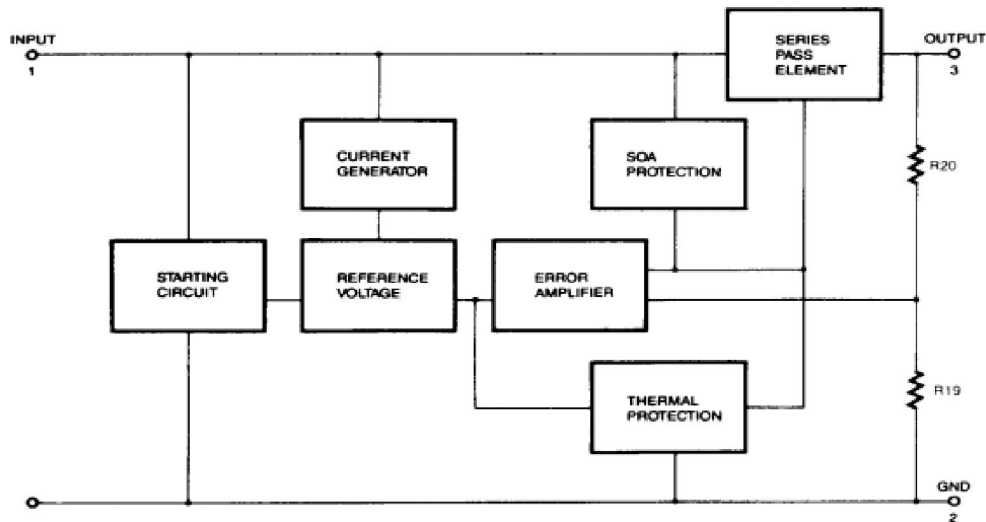

**Absolute Maximum Ratings**

Parameter	Symbol	Value	Unit
Input Voltage	$V_{IN}$	25	V
Out put Voltage	$V_O$	5	V
Continuous total dissipation	$P_D$	1.25	W
Operating Temperature Range	$T_{OPR}$	0 ~ + 125	°C
Storage Temperature Range	$T_{STG}$	-55 ~ + 150	°C

**Electrical Characteristics**

 (Refer to the test circuits,  $I_o=750\text{mA}$ ,  $V_I=10\text{V}$ ,  $C_i = 0.33\mu\text{F}$ ,  $C_o=0.1\mu\text{F}$  unless otherwise specified)

Parameter	Symbol	Conditions	Value			Unit
			Min	Typ	Max	
Output Voltage	$V_o$	$T_j = 25^\circ\text{C}$	4.8		5.2	V
		$V_I = 7 \sim 20\text{V}$ $I_o = 5\text{mA} \sim 1\text{A}$	4.75	5	5.25	
Line Regulation	$\Delta V_o$	$T_j = 25^\circ\text{C}$	$V_I = 7 \sim 25\text{V}$		120	mV
			$V_I = 8 \sim 22\text{V}$		60	
Load Regulation	$\Delta V_o$	$T_j = 25^\circ\text{C}$	$I_o = 5\text{mA} \sim 1\text{A}$		120	mV
			$I_o = 0.25\text{A} \sim 0.75\text{A}$		60	
Quiescent Current	$I_q$	$T_j = 25^\circ\text{C}$			8	mA
Quiescent Current Change	$\Delta I_q$	$I_o = 5\text{mA} \sim 1\text{A}$			0.5	mA
		$V_I = 7 \sim 25\text{V}$			1.2	
Output Voltage Drift	$\Delta V/\Delta T$	$I_o = 5\text{mA}$ $T_j = 0 \text{ to } +125^\circ\text{C}$		-0.8		mV/°C
Output Noise Voltage	$V_N$	$10\text{Hz} \leq f \leq 100\text{kHz}$		40		$\mu\text{V}$
Ripple Rejection	RR	$f = 120\text{Hz}$ , $I_o = 300\text{mA}$ $V_I = 8 \text{ to } 18\text{V}$	60			dB
Dropout Voltage	$V_D$	$T_j = +25^\circ\text{C}$ , $I_o = 1\text{A}$		2		V
Short Circuit Current	$I_{SC}$	$T_j = +25^\circ\text{C}$ , $V_I = 35\text{V}$		300		mA
Peak Current	$I_{PK}$			1.50		A

Notes:

 \*Load and line regulation are specified at constant junction temperature. Change in  $V_o$  due to heating effects must be taken into account separately. Pulse testing with low duty is used.

Typical Characteristics

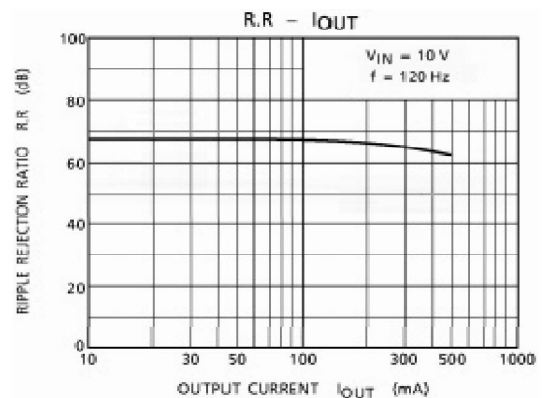
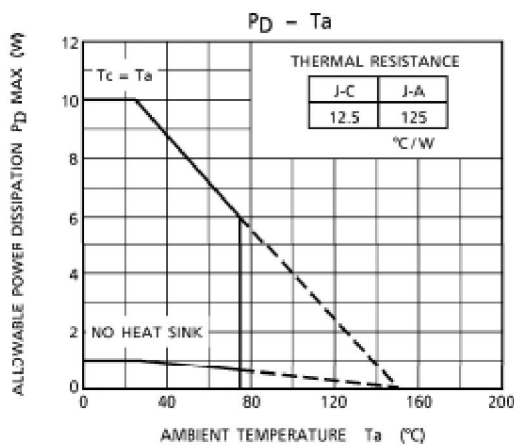
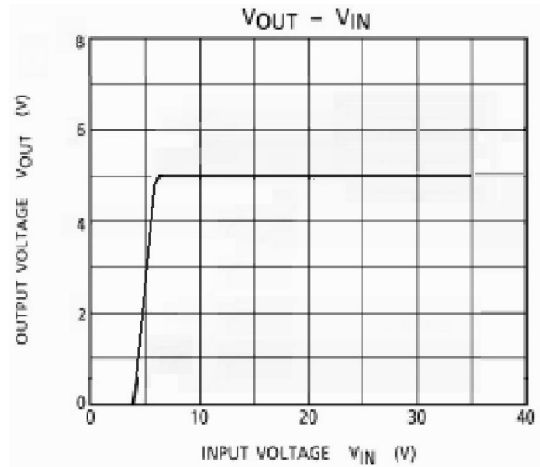
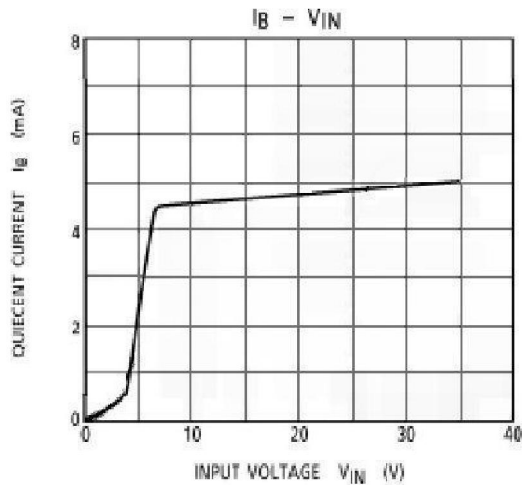
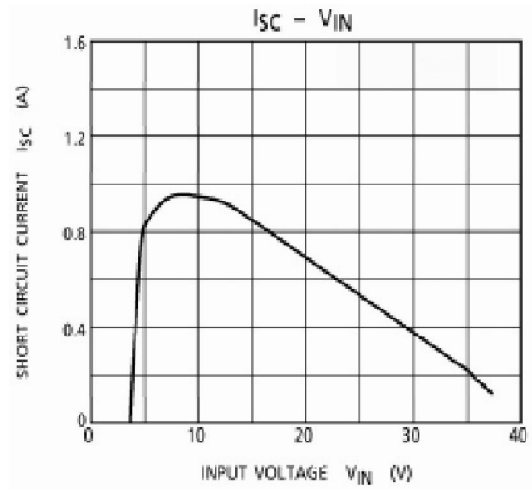
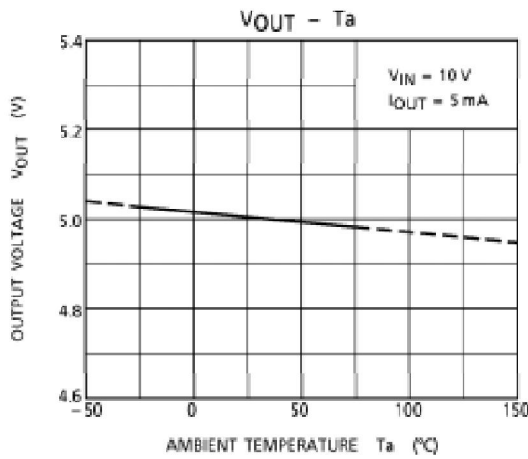

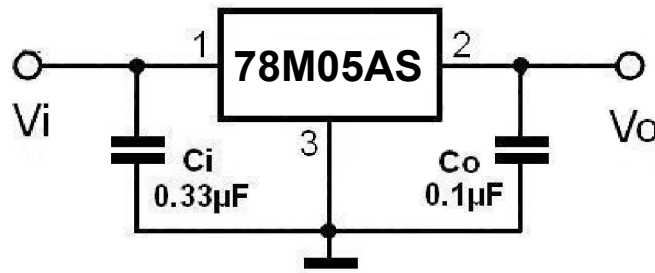

DC Parameter

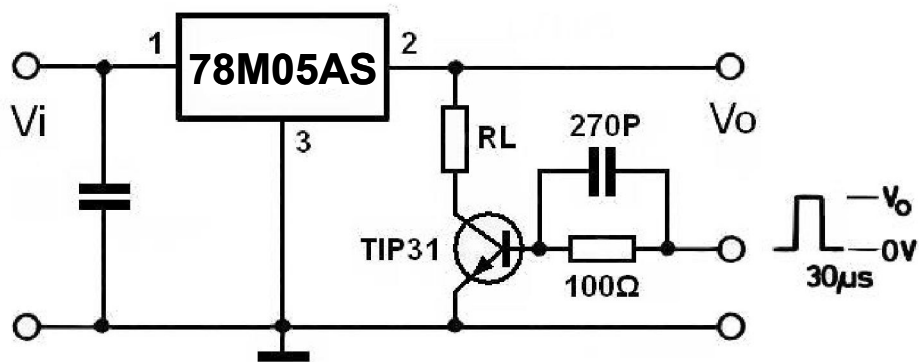

Load Regulation

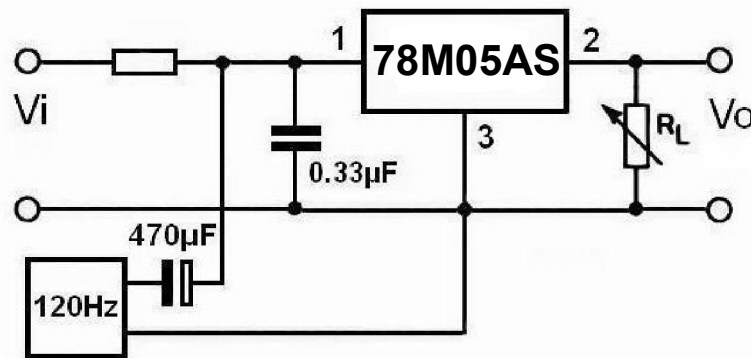

Ripple Rejection

Package Dimensions

TO-263

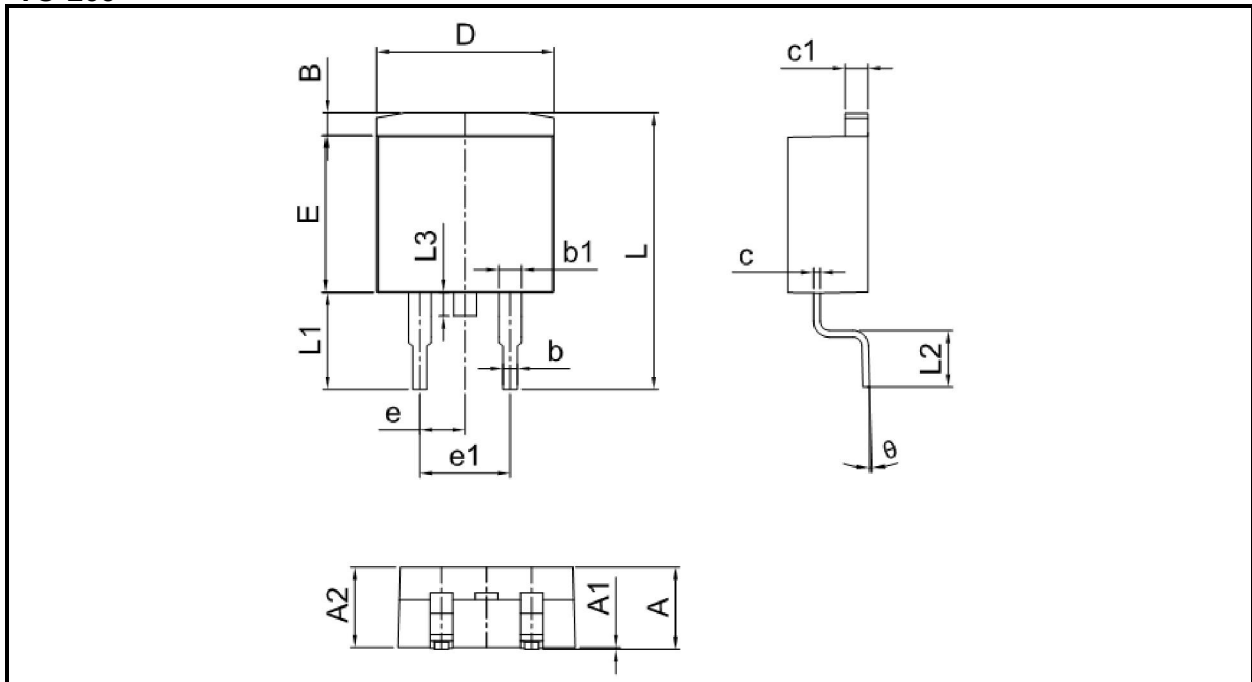

Symbol	Millimeter		Inches	
	Min.	Max.	Min.	Max.
A	4.30	4.70	0.169	0.185
A1	0.00	0.15	0.000	0.006
A2	4.40	4.60	0.173	0.181
B	1.12	1.42	0.044	0.056
b	0.71	0.91	0.028	0.036
b1	1.17	1.37	0.046	0.054
c	0.30	0.50	0.012	0.020
c1	1.17	1.37	0.046	0.054
D	9.90	10.20	0.390	0.402
E	8.50	8.90	0.335	0.350
e	2.44	2.64	0.096	0.104
e1	4.88	5.28	0.192	0.208
F	2.60	2.80	0.102	0.110
L	15.30	15.50	0.602	0.610
L1	5.30	5.50	0.209	0.217
L2	2.34	2.74	0.092	0.108
L3	1.30	1.70	0.051	0.067
θ	0°	8°	0°	8°

Product Specification Classification

Part Number	Package	Marking	Pack
78M05AS	TO-263	YFW 78M05AS XXXXX	800PCS/Reel

单击下面可查看定价，库存，交付和生命周期等信息

[>>YFW\(佑风微\)](#)