

Surface Mount Schottky Barrier Rectifier

Reverse Voltage - 20 to 200 V

Forward Current - 2 A

FEATURES

- ◆ Metal silicon junction, majority carrier conduction
- ◆ For surface mounted applications
- ◆ Low power loss, high efficiency
- ◆ High forward surge current capability
- ◆ For use in low voltage, high frequency inverters, free wheeling, and polarity protection applications
- ◆ Lead free in comply with EU RoHS 2011/65/EU directives

MECHANICAL DATA

- ◆ Case: DO-214AA/SMB
- ◆ Terminals: Solderable per MIL-STD-750, Method 2026
- ◆ Approx. Weight: 0.095g / 0.003oz

Absolute Maximum Ratings and Electrical characteristics
 Ratings at 25 ° ambient temperature unless otherwise specified. Single phase, half wave, 60Hz resistive or inductive load, for capacitive load, derate by 20 %

Pinning

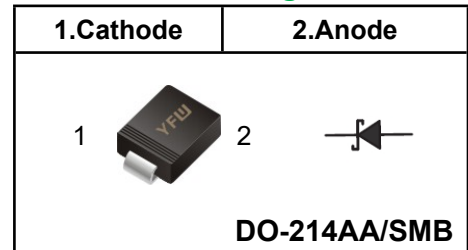

Marking Code

| | |
|---------------|--------------|
| SS22B | SS22 |
| SS24B | SS24 |
| SS26B | SS26 |
| SS28B | SS28 |
| SS210B | SS210 |
| SS212B | SS212 |
| SS215B | SS215 |
| SS220B | SS220 |

| Parameter | Symbols | SS22B | SS24B | SS26B | SS28B | SS210B | SS212B | SS215B | SS220B | Units |
|--|-----------------|------------|-------|-------|----------|--------|--------|--------|--------|-------|
| Maximum Repetitive Peak Reverse Voltage | V_{RRM} | 20 | 40 | 60 | 80 | 100 | 120 | 150 | 200 | V |
| Maximum RMS voltage | V_{RMS} | 14 | 28 | 42 | 56 | 70 | 84 | 105 | 140 | V |
| Maximum DC Blocking Voltage | V_{DC} | 20 | 40 | 60 | 80 | 100 | 120 | 150 | 200 | V |
| Maximum Average Forward Rectified Current | $I_{F(AV)}$ | 2.0 | | | | | | | | A |
| Peak Forward Surge Current, 8.3ms Single Half Sine-wave Superimposed On Rated Load (JEDEC method) | I_{FSM} | 55 | | | | 45 | | | | A |
| Maximum Instantaneous Forward Voltage at 2 A | V_F | 0.55 | | 0.70 | | 0.85 | | 0.90 | | V |
| Maximum Instantaneous Reverse Current at Rated DC Reverse Voltage <small>$T_A = 25^{\circ}C$ $T_A = 100^{\circ}C$</small> | I_R | 0.5 5 | | | 0.3 3 | | | | | mA |
| Typical Junction Capacitance ⁽¹⁾ | C_j | 220 | | | | 110 | | | | pF |
| Typical Thermal Resistance ⁽²⁾ | $R_{\theta JA}$ | 60 | | | | | | | | °C/W |
| Operating Junction Temperature Range | T_j | -55 ~ +150 | | | | | | | | °C |
| Storage Temperature Range | T_{stg} | -55 ~ +150 | | | | | | | | °C |

(1) Measured at 1 MHz and applied reverse voltage of 4 V D.C

(2) P.C.B. mounted with 2.0" X 2.0" (5 X 5 cm) copper pad areas.

Fig.1 Forward Current Derating Curve

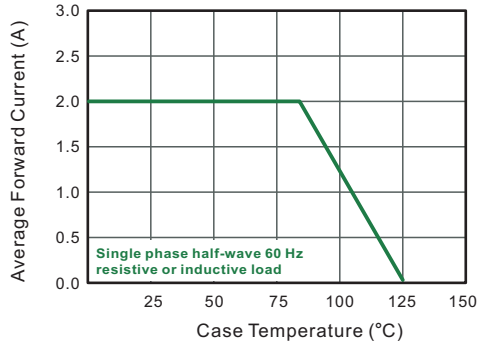

Fig.2 Typical Reverse Characteristics

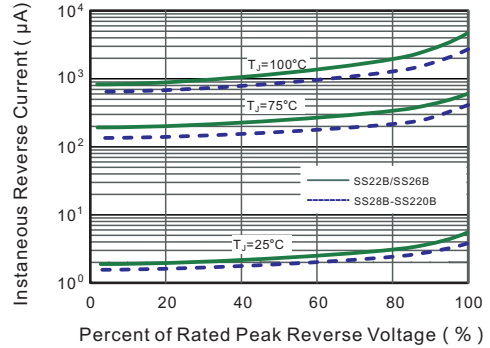

Fig.3 Typical Forward Characteristic

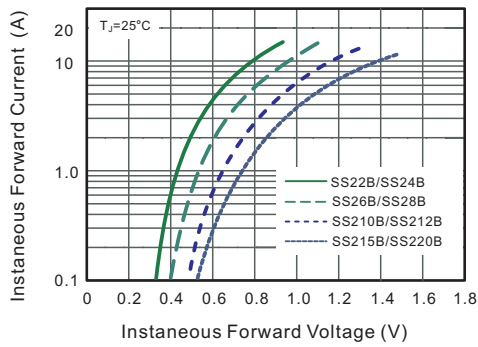

Fig.4 Typical Junction Capacitance

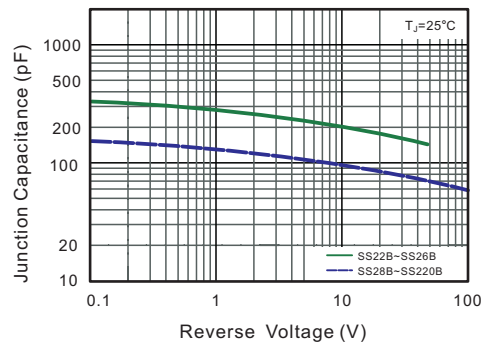

Fig.5 Maximum Non-Repetitive Forward Surge Current

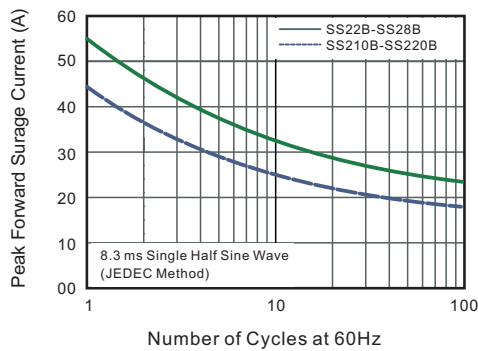
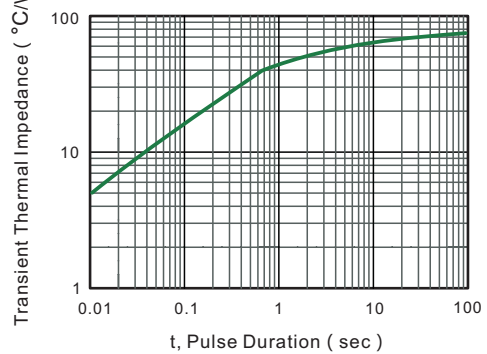
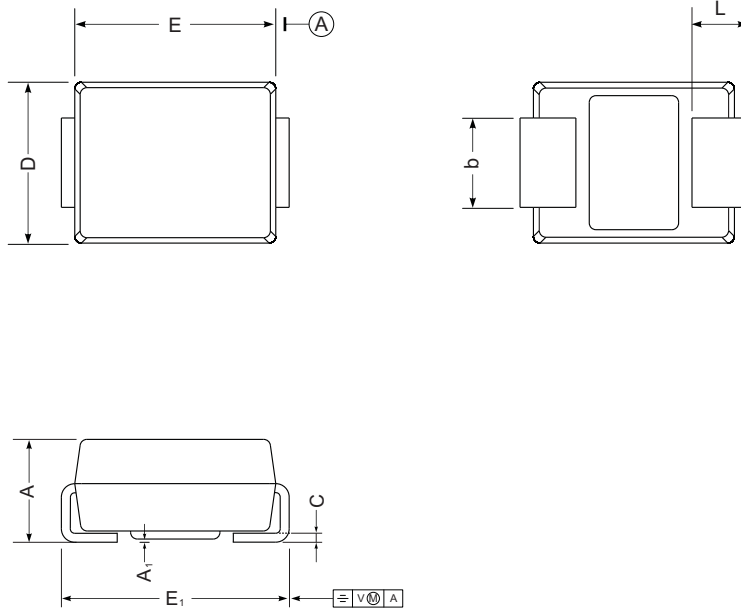

Fig.6- Typical Transient Thermal Impedance



Package Outline DO-214AA SMB

Plastic surface mounted package; 2 leads



| UNIT | | A | E | D | E ₁ | A ₁ | L | C | b |
|------|-----|------|------|------|----------------|----------------|-----|-------|-----|
| mm | max | 2.44 | 4.70 | 3.94 | 5.59 | 0.20 | 1.5 | 0.305 | 2.2 |
| | min | 2.13 | 4.06 | 3.3 | 5.08 | 0.05 | 0.8 | 0.152 | 1.9 |
| mil | max | 96 | 185 | 155 | 220 | 7.9 | 59 | 12 | 87 |
| | min | 84 | 160 | 130 | 200 | 2.0 | 32 | 6 | 75 |

The recommended mounting pad size

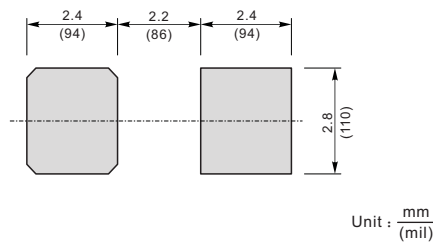

Summary of Packing Options

| Package | Packing Description | Packing Quantity | Industry Standard |
|--------------|---------------------|------------------|-------------------|
| DO-214AA SMB | Tape/Reel, 13" reel | 3000 | EIA-481-1 |

单击下面可查看定价，库存，交付和生命周期等信息

[>>YFW\(佑风微\)](#)