

Low Capacitance ESD Protection -ESDSR05

Description

The ESDSR05 consists of four, low capacitance steering diodes and a low voltage TVS diode that provide protection against ESD and lightning surge events. Each channel or I/O pin can safely absorb up to 25A ($t_p=8/20 \mu s$) and repetitive ESD strikes above the maximum level (Level 4) specified in the IEC 61000-4-2 international standard without performance degradation.

The low capacitance of the steering diode allows the designer to protect high speed data applications. The small SOT-143 package with four leads reduces the internal lead inductance for low overshoot voltage during fast front time transient events such as ESD and EFT.

Features

- Case :JEDEC SOT-143 package
- Low clamping voltage
- Small packaging options saves board space
- Low capacitance :4 pF typical
- Protection for 2 Lines
- Compatible with IEC 61000-4-2(ESD) :Air 15KV , Contact 8KV
- Compatible with IEC 61000-4-4(EFT) :40A ,5/50 nS
- Compatible with IEC 61000-4-5(Surge):24A ,8/20 uS - level 2 (line-GND)&Level 3 (Line-Line)

Applications

- USB Power and Data Line Protection
- 10/100/1000 Ethernet
- Video Graphics Cards
- SIM Ports
- ATM Interfaces

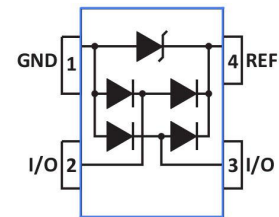

- Montors and Flat Panel Displays
- Digital Video Interface(DVI)

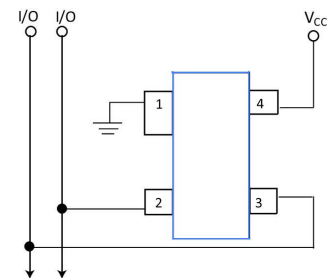

- IEEE 1394 Fire wire Ports

Schematic and PIN Configuration

Application Example Protection

USB Port Protection

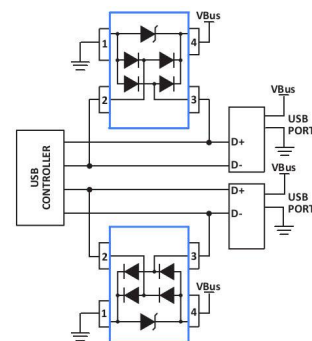

Absolute Maximum Ratings

Parameter	Symbol	Value	Units
Peak Current ($t_p = 8/20 \mu s$)	P_{PK}	500	W
Peak Current ($t_p = 8/20 \mu s$)	I_{PP}	25	A
IEC61000-4-2 (Contact)	V_{ESD}	>8	kV
IEC61000-4-2 (Air)	V_{ESD}	>15	kV
Lead Soldering Temperature	T_L	260 (10 sec)	$^{\circ} C$
Operating Temperature	T_J	-50 to 150	$^{\circ} C$
Storage Temperature Range	T_{STG}	-50 to 150	$^{\circ} C$

Electrical Characteristics ($T = 25^{\circ} C$)

Parameter	Symbol	Conditions	Min.	Typ.	Max.	Units
Reverse Stand-off Voltage	V_{RWM}				5	V
Reverse Breakdown Voltage	V_{BR}	$I_t = 1mA$	6			V
Reverse Leakage Current	I_R	$V_{RWM} = 5.0V, T = 25^{\circ}C$			5	μA
Clamping Voltage	V_C	$I_{PP} = 1A, t_p = 8/20\mu s$			9.8	V
Clamping Voltage	V_C	$I_{PP} = 10A, t_p = 8/20\mu s$			12	V
Junction Capacitance	C_J	$V_R = 0V, f = 1MHz$		0.7	2.5	pF

Rating & Characteristic Curves

Figure 1- Power Derating Curve

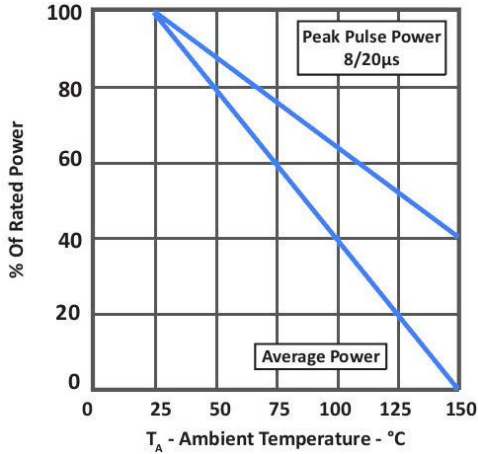

Figure 2- Clamping Voltage vs Current

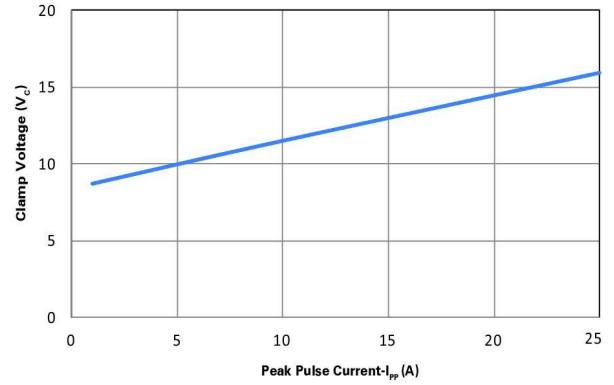

Figure 3- Typical Junction Capacitance

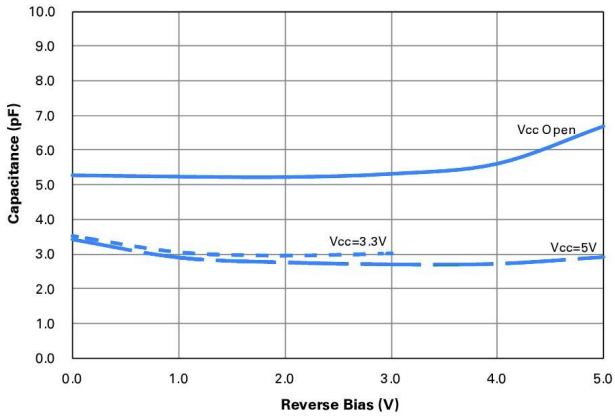
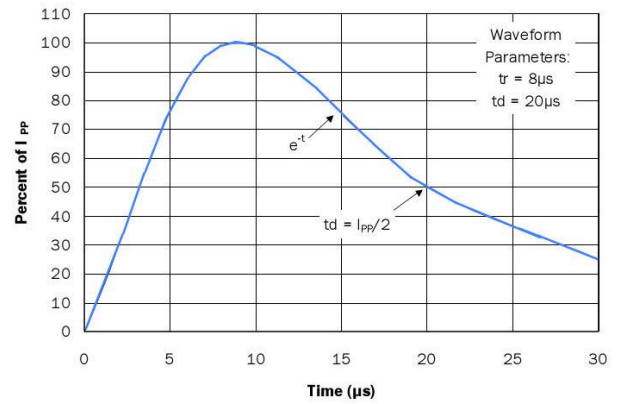
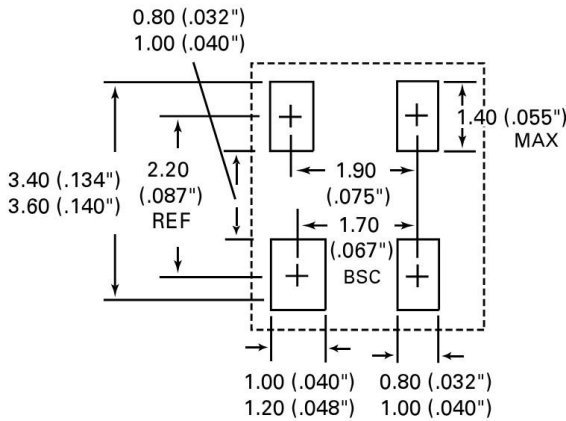
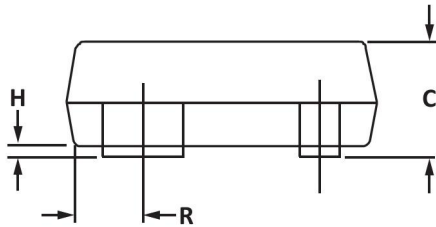
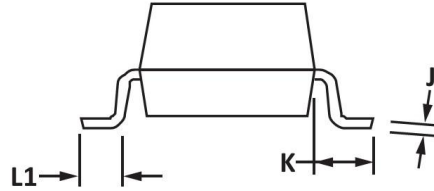
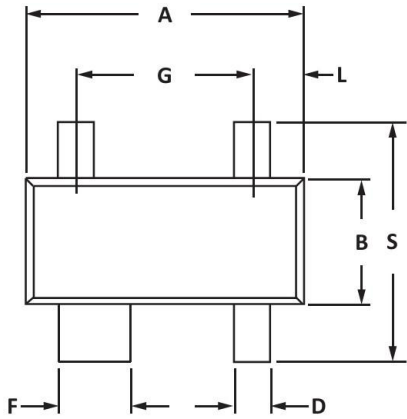

Figure 4- Pulse Waveform



PACKAGE OUTLINE DIMENSIONS in inches (millimeters) SOT-143



Recommended Pad Layout

Dim	Millimeters		Inches	
	MIN	MAX	MIN	MAX
A	2.80	3.04	0.110	0.120
B	1.20	1.39	0.047	0.055
C	0.84	1.14	0.033	0.045
D	0.39	0.50	0.015	0.020
F	0.79	0.93	0.031	0.037
G	1.78	2.03	0.070	0.080
J	0.08	0.15	0.003	0.006
K	0.46	0.60	0.018	0.024
L	0.045	0.60	0.0175	0.024
L1	0.4	0.60	0.016	0.024
R	0.72	0.83	0.028	0.033
S	2.11	2.48	0.083	0.098

Disclaimer

Specifications are subject to change without notice.

The device characteristics and parameters in this data sheet can and do vary in different applications and actual device performance may vary over time.

Users should verify actual device performance in their specific applications.

单击下面可查看定价，库存，交付和生命周期等信息

[>>Yint\(音特电子\)](#)