

SI2302

SOT-23 Plastic-Encapsulate Transistors

SI2302 MOSFET(N-Channel)

FEATURES

TrenchFET Power MOSFET

MARKING: A2sHB:

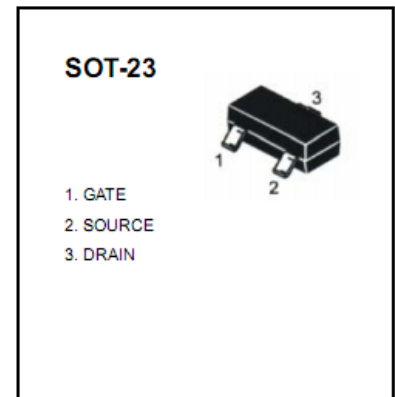
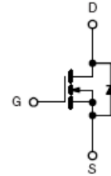

MAXIMUM RATINGS (TA=25°C unless otherwise noted)

Symbol	Parameter	Value	Units
V _{DS}	Drain-Source voltage	20	V
V _{GS}	Gate-Source voltage	± 12	V
I _D	Drain current	2.5	A
P _D	Power Dissipation	0.9	W
T _j	Junction Temperature	150	°C
T _{stg}	Storage Temperature	-55-150	°C

ELECTRICAL CHARACTERISTICS (T_{amb}=25°C unless otherwise specified)

Parameter	Symbol	Test conditions	MIN	TYP	MAX	UNIT
Drain-Source Breakdown Voltage	V _{(BR)DSS}	V _{GS} =0V, I _D =250μA	20			V
Gate-Threshold Voltage	V _{th(GS)}	V _{DS} =V _{GS} , I _D =250 μA	0.5	0.75	1.2	V
Gate-body Leakage	I _{GSS}	V _{DS} =0V, V _{GS} =± 10V			± 100	nA
Zero Gate Voltage Drain Current	I _{DSS}	V _{DS} =20V, V _{GS} =0V			1	μA
Drain-Source On-Resistance	r _{DS(ON)}	V _{GS} =2.5V, I _D =1.0A		50	85	mΩ
		V _{GS} =4.5V, I _D =2.5A		40	50	mΩ
Forward Trans conductance	g _{fs}	V _{DS} =5V, I _D =2.9A		8.0		s
Dynamic Characteristics						
Input Capacitance	C _{iss}	V _{DS} =10V, V _{GS} =0V, f=1MHz		260		pF
Output Capacitance	C _{oss}			48		
Reverse Transfer Capacitance	C _{rss}			27		
Switching Capacitance						
Turn-on Delay Time	t _{d(on)}	V _{DD} =10V, I _D =2.5A, V _{GS} =4.5V R _{GEN} =2.8Ω		2.5		nS
Turn-on Rise Time	t _r			3.2		nS
Turn-off Delay Time	t _{d(off)}			21		nS
Turn-off Fall Time	t _f			3.0		nS
Total Gate Charge	Q _g	V _{DS} =10V, I _D =2.5A, V _{GS} =4.5V,		2.9		nC
Gate-Source Charge	Q _{gs}			0.4		nC
Gate-Drain Charge	Q _{gd}			0.6		nC
Drain-Source Diode Characteristics						
Diode Forward Voltage	V _{SD}	V _{GS} =0V, I _S =2.5A			1.2	V
Diode Forward Current	I _S				2.0	A

Typical Characteristics

Switch Time Test Circuit and Switching Waveforms:

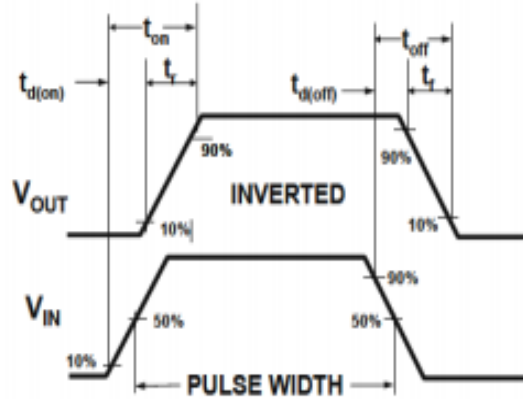
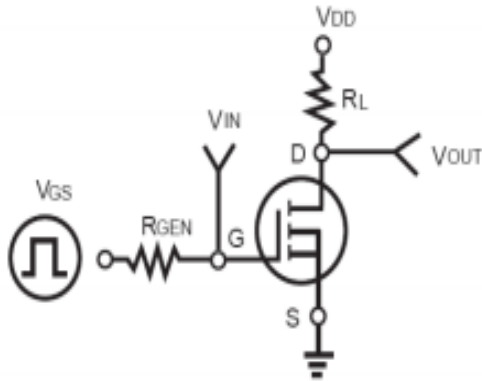

TYPICAL ELECTRICAL AND THERMAL CHARACTERISTICS (Curves)

Figure1. Power Dissipation

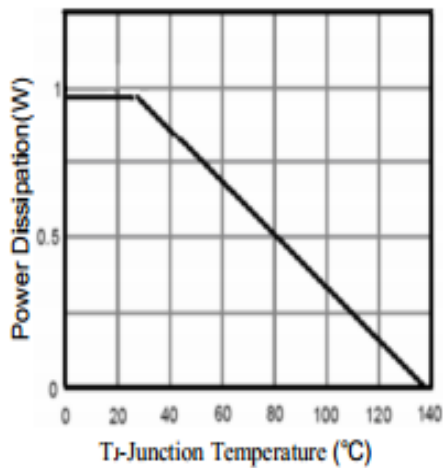

Figure2. Drain Current

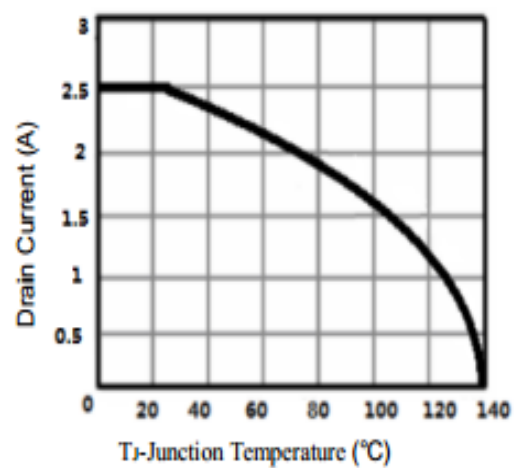

Figure3. Output Characteristics

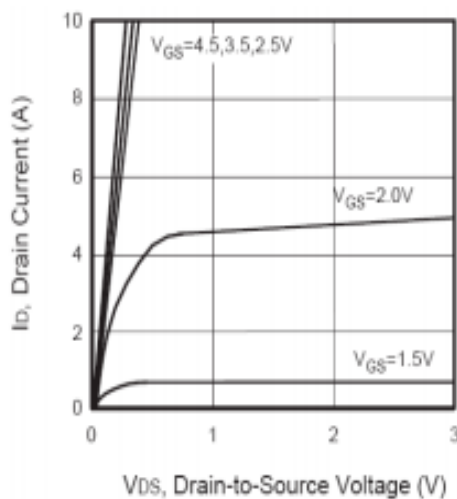
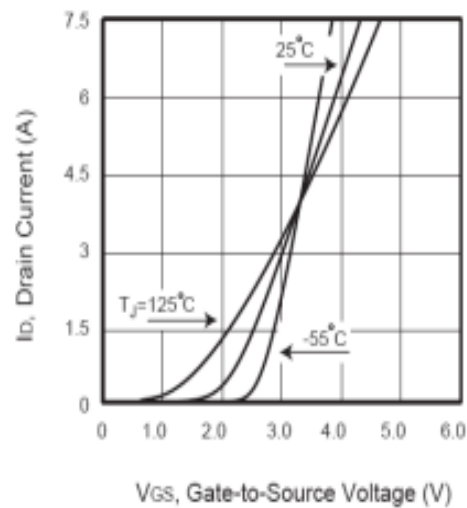

Figure4. Transfer Characteristics



单击下面可查看定价，库存，交付和生命周期等信息

[>>YONGYUTAI\(永裕泰\)](#)