

TRANSISTOR (NPN)

FEATURES

- Epitaxial Planar Die Construction
- Complementary PNP Type Available (MMBT3906)
- Ideal for Medium Power Amplification and Switching

MARKING: 1AM

SOT-23

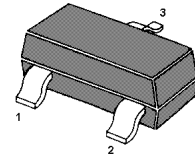

1. BASE
2. EMITTER
3. COLLECTOR

MAXIMUM RATINGS (T_a=25°C unless otherwise noted)

Symbol	Parameter	Value	Unit
V _{CB0}	Collector-Base Voltage	60	V
V _{CEO}	Collector-Emitter Voltage	40	V
V _{EBO}	Emitter-Base Voltage	6	V
I _C	Collector Current	200	mA
P _C	Total Device Dissipation	200	mW
R _{θJA}	Thermal Resistance From Junction to Ambient	625	°C/W
T _J	Junction Temperature	150	°C
T _{stg}	Storage Temperature	-55 ~ +150	°C

ELECTRICAL CHARACTERISTICS (T_a=25°C unless otherwise specified)

Parameter	Symbol	Test conditions	Min	Max	Unit
Collector-base breakdown voltage	V _{(BR)CBO}	I _C = 10μA, I _E =0	60		V
Collector-emitter breakdown voltage	V _{(BR)CEO}	I _C = 1mA, I _B =0	40		V
Emitter-base breakdown voltage	V _{(BR)EBO}	I _E =10μA, I _C =0	6		V
Collector cut-off current	I _{CB0}	V _{CB} =60V, I _E =0		0.1	μA
Collector cut-off current	I _{CEX}	V _{CE} =30V, V _{BE(off)} =3V		50	nA
Emitter cut-off current	I _{EBO}	V _{EB} =5V, I _C =0		0.1	μA
DC current gain	h _{FE(1)}	V _{CE} =1V, I _C =10mA	100	300	
	h _{FE(2)}	V _{CE} =1V, I _C = 50mA	60		
	h _{FE(3)}	V _{CE} =1V, I _C = 100mA	30		
Collector-emitter saturation voltage	V _{CE(sat)}	I _C =50mA, I _B = 5mA		0.3	V
Base-emitter saturation voltage	V _{BE(sat)}	I _C = 50mA, I _B = 5mA		0.95	V
Transition frequency	f _T	V _{CE} =20V, I _C =10mA, f=100MHz	300		MHz
Delay Time	t _d	V _{CC} =3V, V _{BE} =-0.5V		35	nS
Rise Time	t _r	I _C =10mA, I _{B1} =-I _{B2} =1.0mA		35	nS
Storage Time	t _s	V _{CC} =3V, I _C =10mA,		200	nS
Fall Time	t _f	I _{B1} =-I _{B2} =1mA		50	nS

MMBT3904

Typical Characteristics

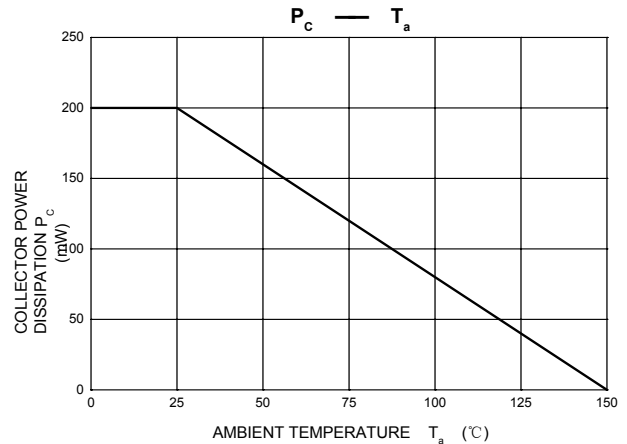
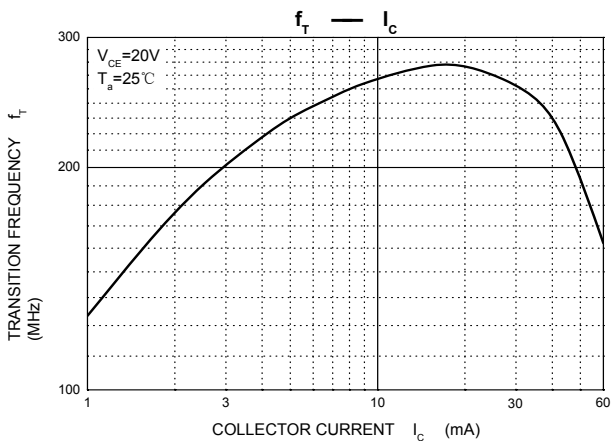
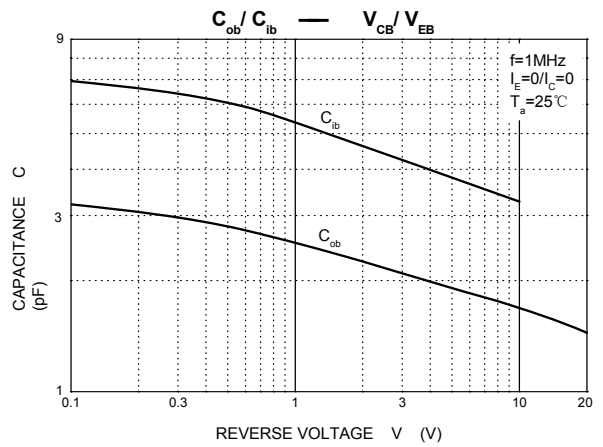
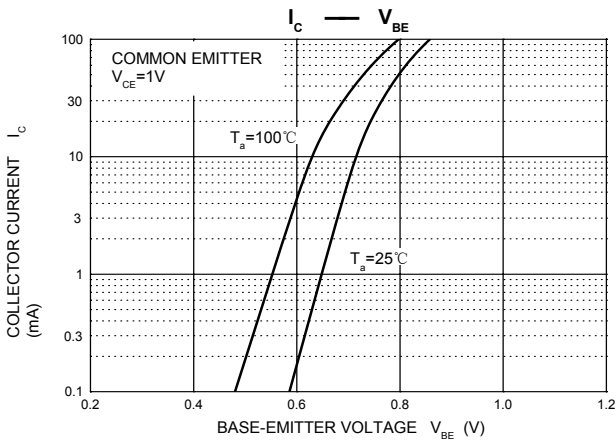
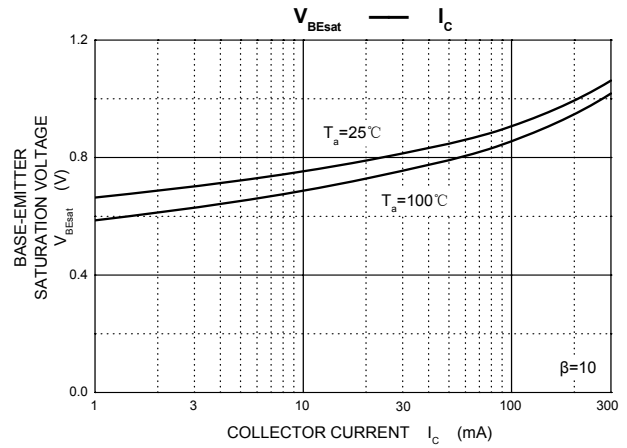
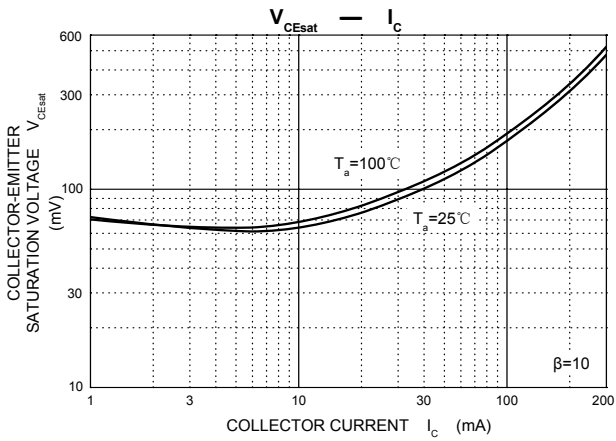
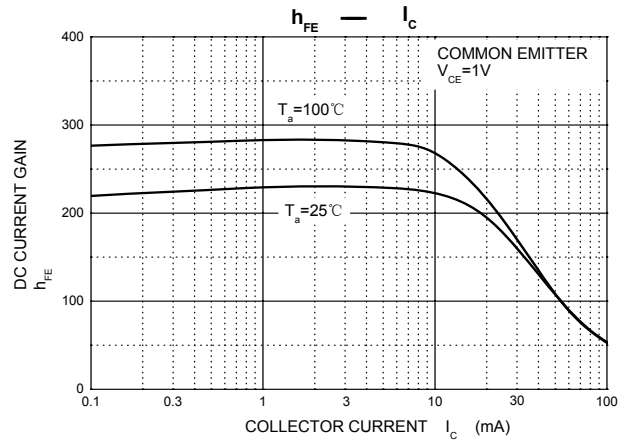
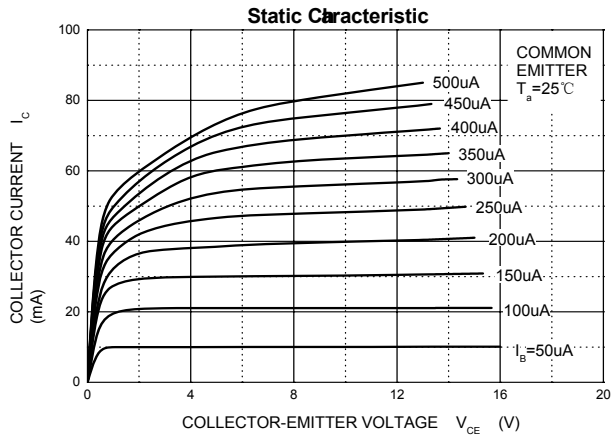

PACKAGE OUTLINE

Plastic surface mounted package; 3 leads

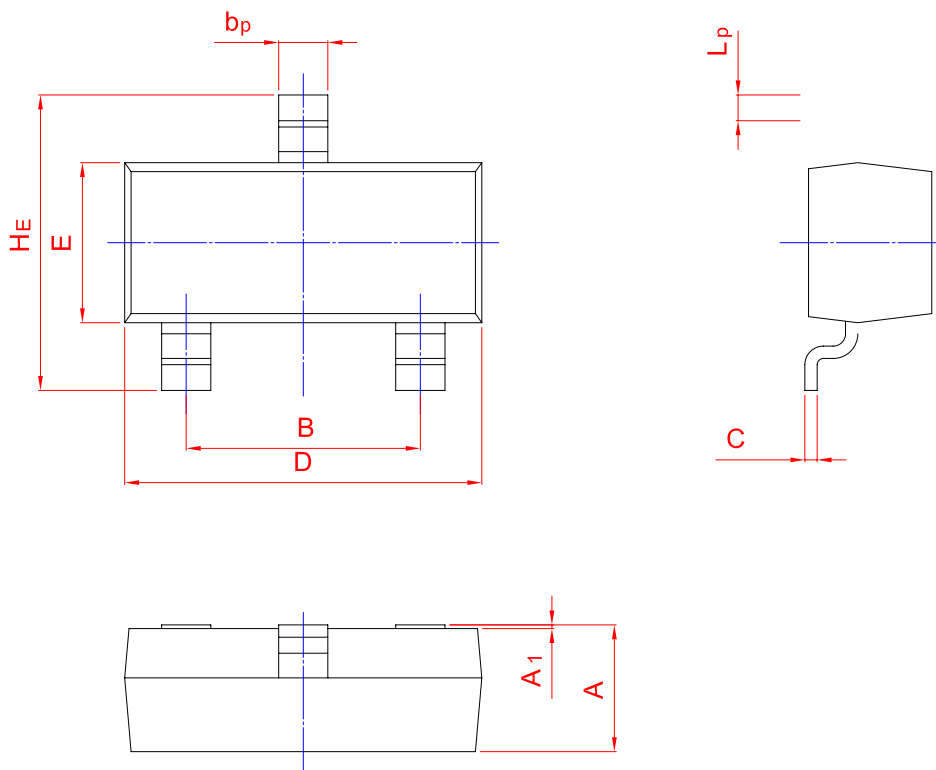
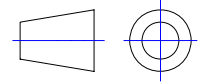
SOT-23

UNIT	A	B	bp	C	D	E	HE	A1	Lp
mm	1.40	2.04	0.50	0.19	3.10	1.65	3.00	0.100	0.50
	0.95	1.78	0.35	0.08	2.70	1.20	2.20	0.013	0.20

单击下面可查看定价，库存，交付和生命周期等信息

[>>YONGYUTAI\(永裕泰\)](#)