

BAW56/BAV70/BAV99

BAW56/BAV70/BAV99 SWITCHING DIODE

FEATURES

- Fast Switching Speed
- For General Purpose Switching Applications
- High Conductance

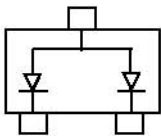
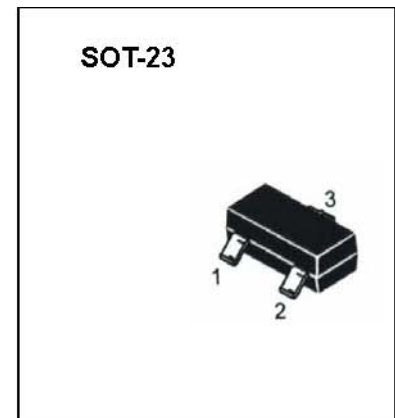

BAW56 Marking: A1

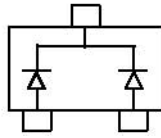

BAV70 Marking: A4

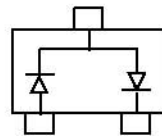

BAV99 Marking: A7

Maximum Ratings @TA=25°C

Parameter	Symbol	Limits	Unit
Reverse voltage	V_R	70	V
Forward Current	I_F	200	mA
Peak Forward Surge Current	$I_{FM(surge)}$	500	mA
Power Dissipation	P_D	225	mW
Thermal Resistance Junction to Ambient Air	$R_{\theta JA}$	556	°C/W
Junction temperature	T_J	150	°C
Storage temperature range	T_{STG}	-55-150	°C

Electrical Characteristics @TA=25°C

Parameter	Symbol	Min.	Typ.	Max.	Unit	Conditions
Reverse Breakdown Voltage	V_R	70			V	$I_R=100\mu A$
Forward voltage	V_{F1}			0.715	V	$I_F=1mA$
	V_{F2}			0.855	V	$I_F=10mA$
	V_{F3}			1	V	$I_F=50mA$
	V_{F4}			1.25	V	$I_F=150mA$
Reverse current	I_R			2.5	μA	$V_R=70V$
Capacitance between terminals	C_T			1.5	pF	$V_R=0, f=1MHz$
Reverse recovery time	t_{rr}			6	ns	$I_F = I_R = 10mA, I_{rr} = 0.1 \times I_R, R_L = 100\Omega$

Typical Characteristics

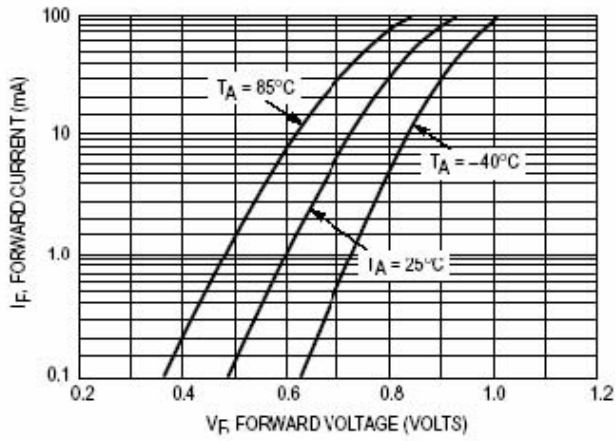

Figure 1. Forward Voltage

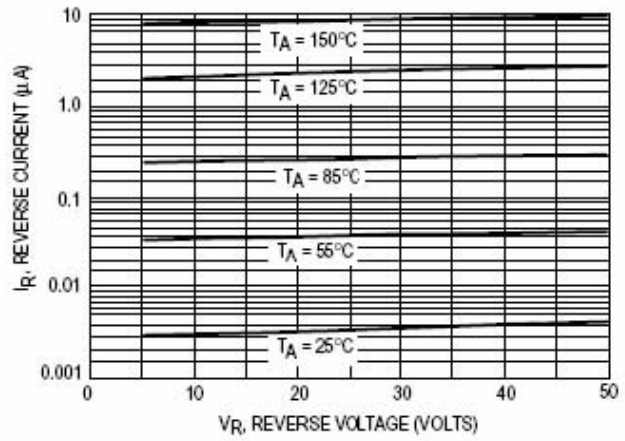

Figure 2. Leakage Current

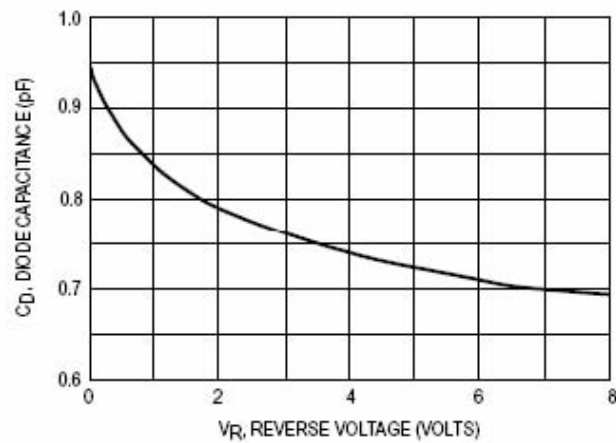

Figure 3. Capacitance

单击下面可查看定价，库存，交付和生命周期等信息

[>>YONGYUTAI\(永裕泰\)](#)