

BTA12-800B
MAIN FEATURES 4Q TRIAC

Symbol	Value	Unit
$I_{T(RMS)}$	12	A
V_{DRM}/V_{RRM}	800	V
$I_{GT1/2/3}$	50/50/50/70	mA

DESCRIPTION:

The BTA12-800B triac is suitable for general purpose AC switching. It can be used as an ON/OFF function in applications such as heating regulation, induction motor starting circuits, for phase control operation in light dimmers, motor speed controllers. By using an external plastic package.

Package TO-220F is RoHS compliant.

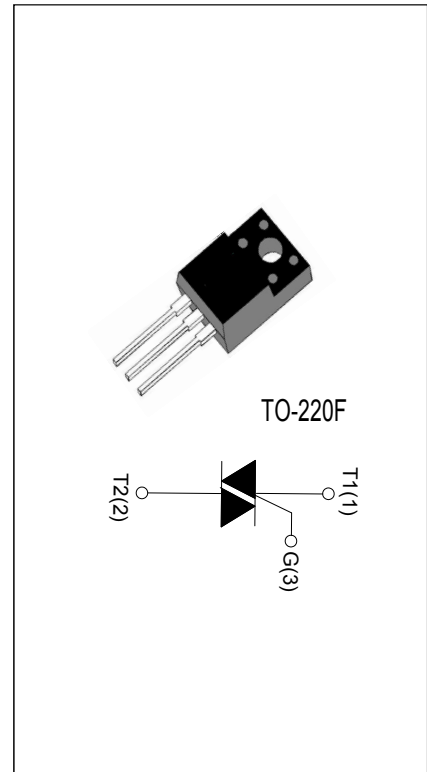
ABSOLUTE MAXIMUM RATINGS

Parameter	Symbol	Value	Unit
Storage junction temperature range	T_{stg}	-40-150	°C
Operating junction temperature range	T_j	-40-125	°C
Repetitive peak off-state voltage ($T_j=25^\circ\text{C}$)	V_{DRM}	800	V
Repetitive peak reverse voltage ($T_j=25^\circ\text{C}$)	V_{RRM}	800	V
RMS on-state current ($T_c \leq 90^\circ\text{C}$)	$I_{T(RMS)}$	12	A
Non repetitive surge peak on-state current (full cycle, $t_p=20\text{ms}$, $T_j=25^\circ\text{C}$)	I_{TSM}	120	A
I^2t value for fusing ($t_p=10\text{ms}$, $T_j=25^\circ\text{C}$)	I^2t	72	A^2s
Critical rate of rise of on-state current ($T_j=125^\circ\text{C}$)	di/dt	50	$\text{A}/\mu\text{s}$
Peak gate current ($t_p=20\mu\text{s}$, $T_j=125^\circ\text{C}$)	I_{GM}	4	A
Average gate power dissipation ($T_j=125^\circ\text{C}$)	$P_{G(AV)}$	10	W

ELECTRICAL CHARACTERISTICS ($T_j=25^{\circ}\text{C}$ unless otherwise specified)

Symbol	Test Condition	Quadrant	Value		Unit
I_{GT}	$V_D=12\text{V}$ $R_L=100\Omega$	I - II -III	MAX.	50	mA
		IV		70	
V_{GT}		ALL	MAX.	1	V
V_{GD}	$V_D=V_{DRM}$ $T_j=125^{\circ}\text{C}$ $R_L=100\Omega$	ALL	MIN.	0.2	V
I_L	$I_G=1.2I_{GT}$	I -III-IV	MAX.	60	mA
		II		100	
I_H	$I_T=500\text{mA}$		MAX.	60	mA
dV/dt	$V_D=2/3V_{DRM}$ $T_j=125^{\circ}\text{C}$		MIN.	500	V/ μs
$(dI/dt)_c$	$T_j=125^{\circ}\text{C}$		MIN.	8	A/ms

STATIC CHARACTERISTICS

Symbol	Parameter		Value(MAX.)	Unit
V_{TM}	$I_{TM}=32\text{A}$	$T_j=25^{\circ}\text{C}$	1.50	V
V_{TO}	Threshold voltage	$T_j=125^{\circ}\text{C}$	0.86	V
R_D	Dynamic resistance	$T_j=125^{\circ}\text{C}$	36.6	$\text{m}\Omega$
I_{DRM}	$V_D=V_{DRM}$ $V_R=V_{RRM}$	$T_j=25^{\circ}\text{C}$	5	μA
I_{RRM}		$T_j=125^{\circ}\text{C}$	1	mA

THERMAL RESISTANCES

Symbol	Parameter	Value	Unit
$R_{th(j-c)}$	junction to case (AC)	2.05	$^{\circ}\text{C}/\text{W}$

ORDERING INFORMATION

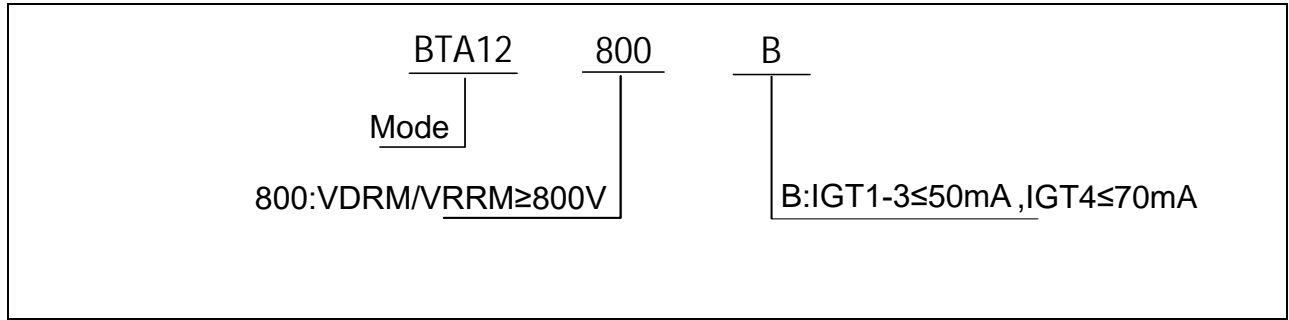

MARKING

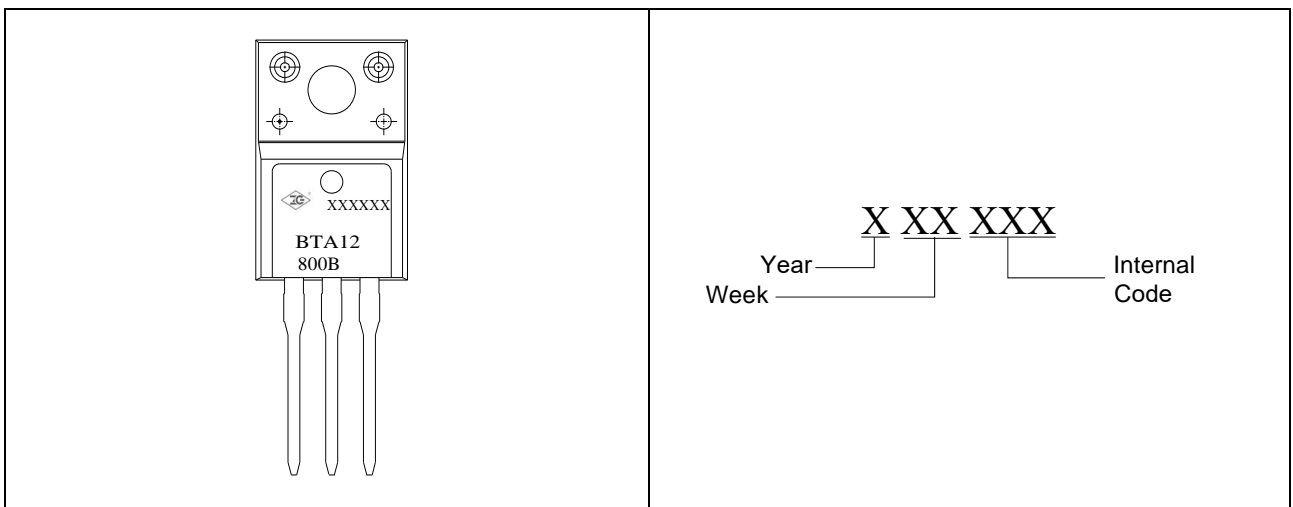

ORDERING INFORMATION

Order code	Voltage V _{DRM} /V _{RRM} (V)	IGT(mA)		Package	Base qty. (pcs)	Delivery mode
		I - II - III	IV			
BTA12-800B	800	50	70	TO-220F	50	Tube

FIG.1 Maximum power dissipation versus RMS on-state current

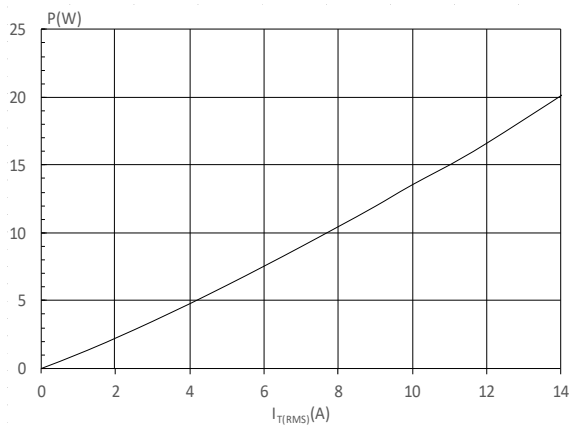

FIG.2: RMS on-state current versus case temperature

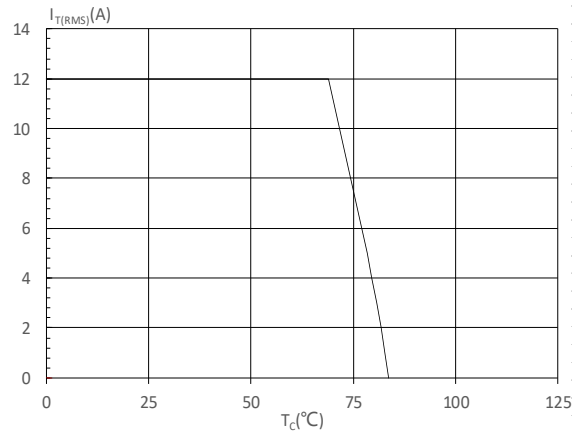

FIG.3: Surge peak on-state current versus number of cycles

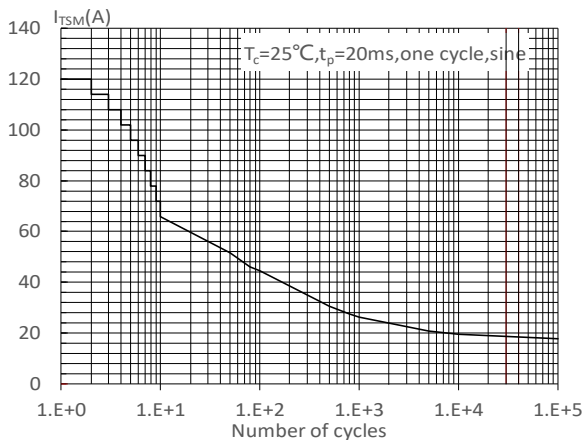

FIG.4: On-state characteristics

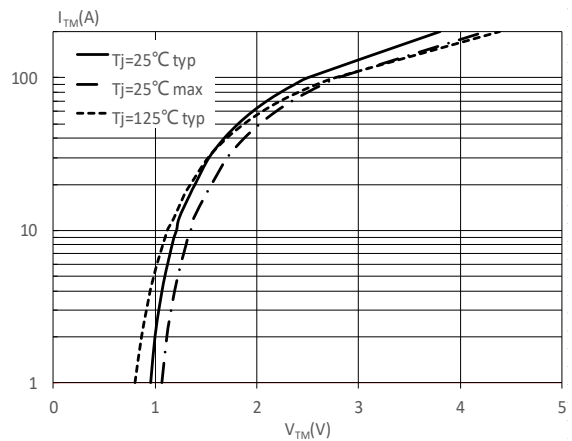

FIG.5: Non-repetitive surge peak on-state current for a sinusoidal pulse with width $t_p < 20ms$, and corresponding value of I^2t (I - II : $di/dt < 80A/\mu s$; III-IV : $di/dt < 40A/\mu s$)

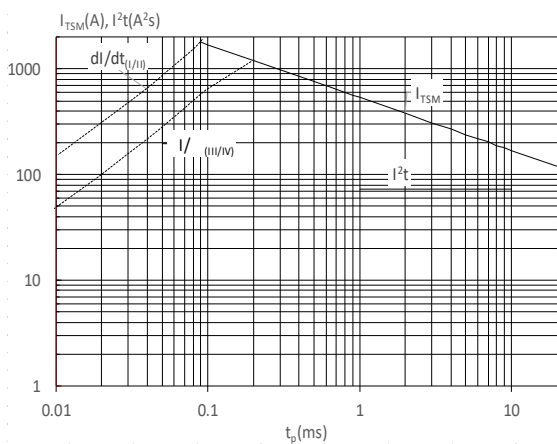
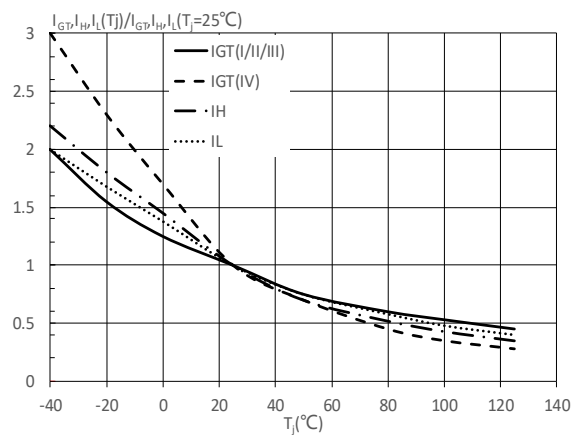

FIG.6: Relative variations of gate trigger current, holding current and latching current versus junction temperature



单击下面可查看定价，库存，交付和生命周期等信息

[>>ZG\(中鑫半导体\)](#)