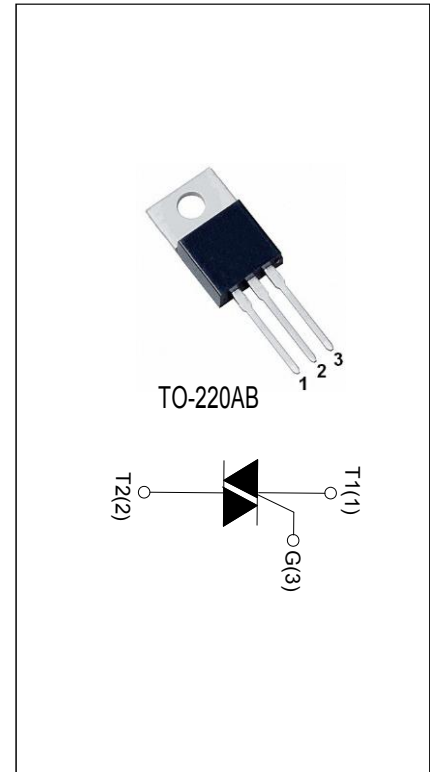

**BTA08-800BW**
**MAIN FEATURES 3Q TRIAC**

Symbol	Value	Unit
$I_{T(RMS)}$	8	A
$V_{DRM}/V_{RRM}$	800	V
$I_{GT1/2/3}$	50/50/50	mA

**DESCRIPTION:**

The BTA08-800BW triac is suitable for general purpose AC switching. It can be used as an ON/OFF function in applications such as heating regulation, induction motor starting circuits, for phase control operation in light dimmers, motor speed controllers. BTA08-800BW snubberless triac is especially recommended for use on inductive loads. It can be driven directly through the MCU I/O port. By using an internal ceramic pad, Package TO-220AB RoHS compliant.

**ABSOLUTE MAXIMUM RATINGS**

Parameter	Symbol	Value	Unit
Storage junction temperature range	$T_{stg}$	-40-150	$^{\circ}C$
Operating junction temperature range	$T_j$	-40-125	$^{\circ}C$
Repetitive peak off-state voltage ( $T_j=25^{\circ}C$ )	$V_{DRM}$	800	V
Repetitive peak reverse voltage ( $T_j=25^{\circ}C$ )	$V_{RRM}$	800	V
RMS on-state current ( $T_c \leq 80^{\circ}C$ )	$I_{T(RMS)}$	8	A
Non repetitive surge peak on-state current (full cycle, $t_p=20ms$ , $T_j=25^{\circ}C$ )	$I_{TSM}$	80	A
$I^2t$ value for fusing ( $t_p=10ms$ , $T_j=25^{\circ}C$ )	$I^2t$	64	$A^2s$
Critical rate of rise of on-state current ( $T_j=125^{\circ}C$ )	$di/dt$	50	$A/\mu s$
Peak gate current ( $t_p=20\mu s$ , $T_j=125^{\circ}C$ )	$I_{GM}$	4	A
Average gate power dissipation ( $T_j=125^{\circ}C$ )	$P_{G(AV)}$	1	W

**ELECTRICAL CHARACTERISTICS** ( $T_j=25^\circ\text{C}$  unless otherwise specified)

Symbol	Test Condition	Quadrant	Value		Unit
$I_{GT}$	$V_D=12\text{V}$ $R_L=100\Omega$	I - II -III	MAX.	50	mA
$V_{GT}$		I - II -III	MAX.	1	V
$V_{GD}$	$V_D=V_{DRM}$ $T_j=125^\circ\text{C}$ $R_L=100\Omega$	I - II -III	MIN.	0.2	V
$I_L$	$I_G=1.2I_{GT}$	I -III	MAX.	60	mA
		II		100	
$I_H$	$I_T=500\text{mA}$		MAX.	60	mA
$dV/dt$	$V_D=2/3V_{DRM}$ $T_j=125^\circ\text{C}$		MIN.	500	V/ $\mu\text{s}$
$(dI/dt)_c$	$T_j=125^\circ\text{C}$		MIN.	10	A/ms

**STATIC CHARACTERISTICS**

Symbol	Parameter		Value(MAX.)	Unit
$V_{TM}$	$I_{TM}=32\text{A}$	$T_j=25^\circ\text{C}$	1.5	V
$V_{TO}$	Threshold voltage	$T_j=125^\circ\text{C}$	0.86	V
$R_D$	Dynamic resistance	$T_j=125^\circ\text{C}$	36.6	$\text{m}\Omega$
$I_{DRM}$	$V_D=V_{DRM}$ $V_R=V_{RRM}$	$T_j=25^\circ\text{C}$	5	$\mu\text{A}$
$I_{RRM}$		$T_j=125^\circ\text{C}$	1	mA

**THERMAL RESISTANCES**

Symbol	Parameter	Value	Unit
$R_{th(j-c)}$	junction to case (AC)	2.05	$^\circ\text{C}/\text{W}$

**ORDERING INFORMATION**

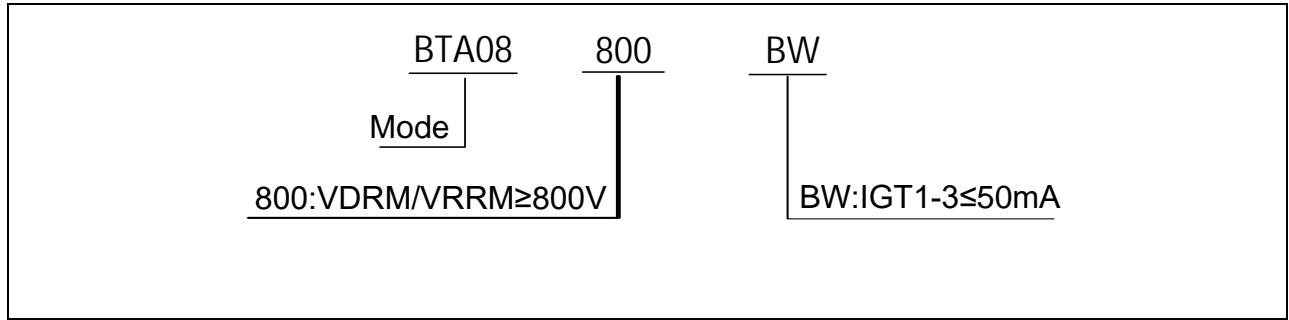

**MARKING**

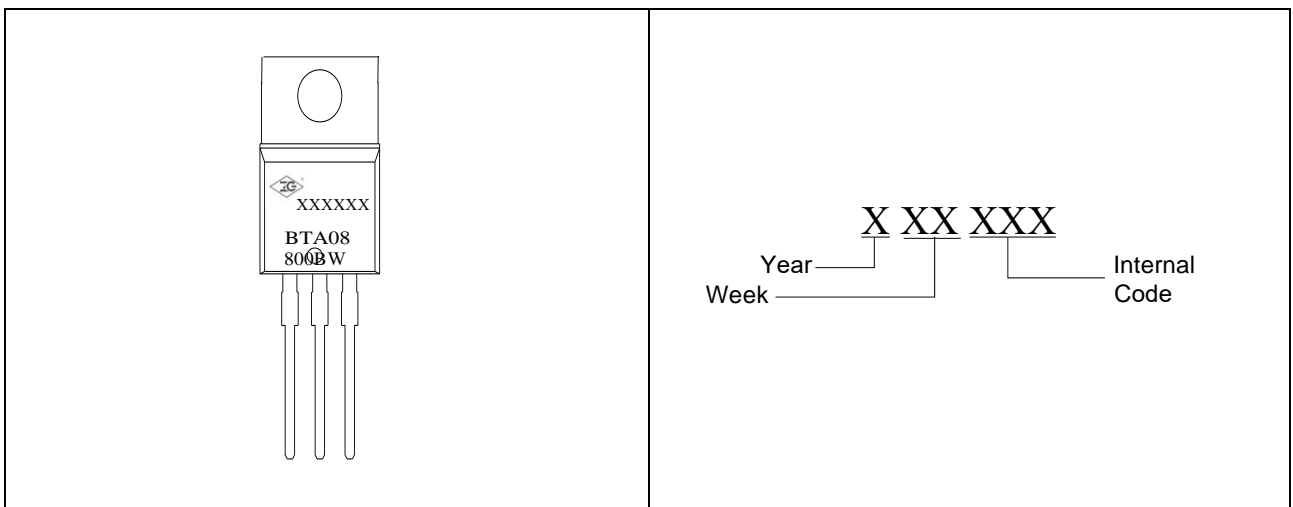

**ORDERING INFORMATION**

Order code	Voltage V <sub>DRM</sub> /V <sub>R<sub>RRM</sub></sub> (V)	IGT(mA)	Package	Base qty. (pcs)	Delivery mode
		I -II-III			
BTA08-800BW	800	50	TO-220AB	50	Tube

PACKAGE MECHANICAL DATA



TO-220AB

Ref.	Dimensions		
	Millimeters		
	Min.	Typ.	Max.
A	4.30	4.50	4.70
B	0.60	0.80	1.00
C	0.28	0.38	0.48
C2	1.17	1.27	1.37
C3	2.30	2.50	2.70
D	8.80	9.00	9.20
E	9.80	10.00	10.20
G	2.44	2.54	2.64
H	28.55	28.85	29.15
L2	1.10	1.30	1.50
L3	2.59	2.74	2.89

DELIVERY MODE

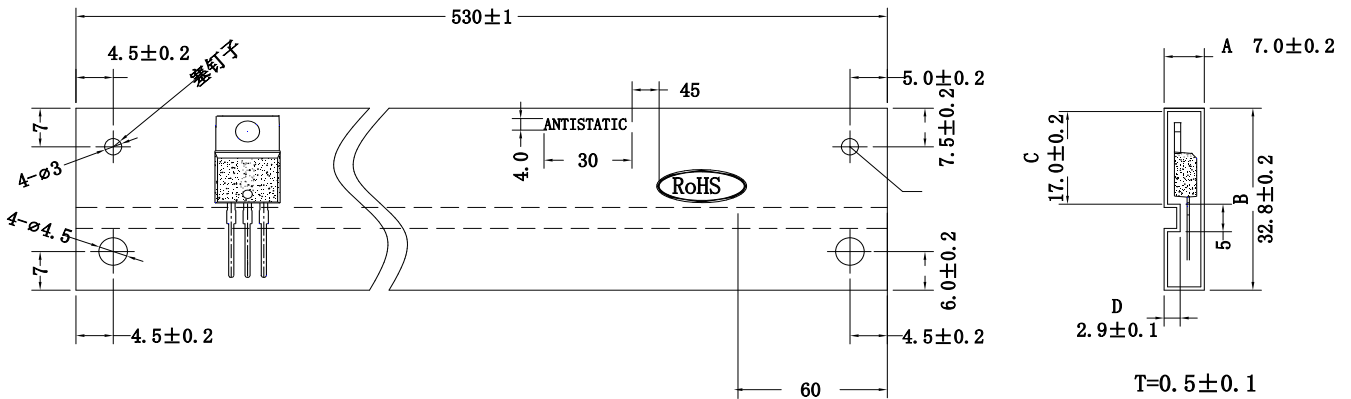

PACKAGE	OUTLINE	TUBE (PCS)	INNER BOX (PCS)	PER CARTON
TO-220AB	TUBE	50	1,000	5,000

FIG.1: Maximum power dissipation versus RMS on-state current (full cycle)

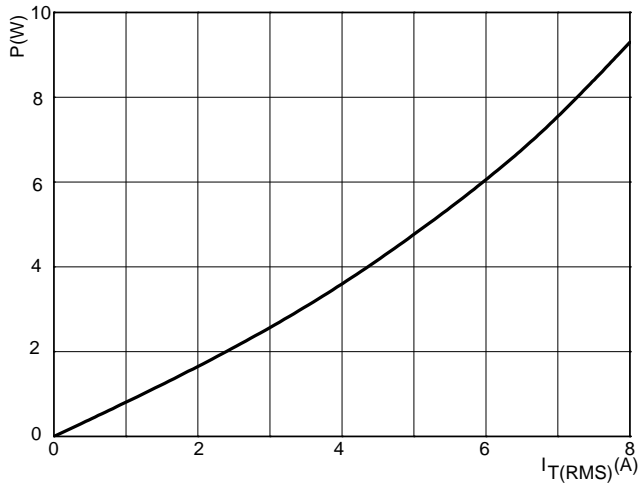

FIG.2: RMS on-state current versus case temperature (full cycle)

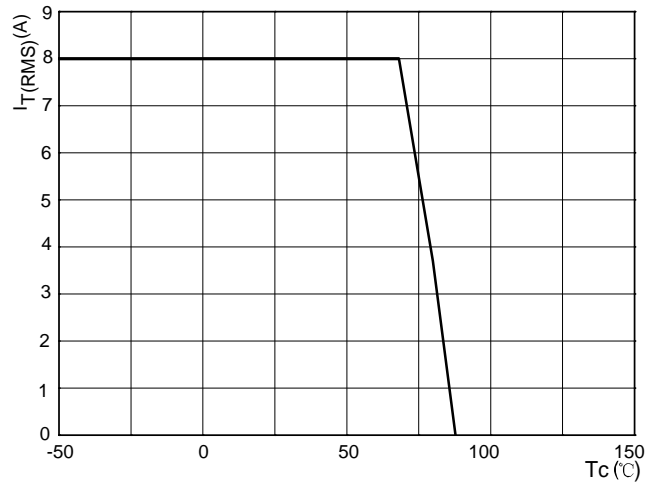

FIG.3: Surge peak on-state current versus number of cycles

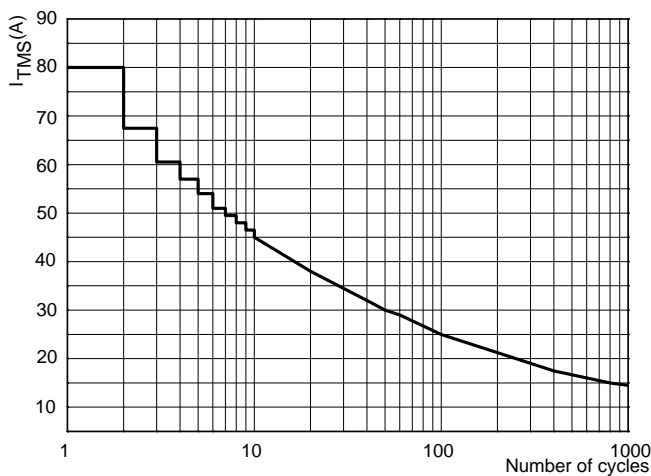

FIG.4: On-state characteristics (maximum values)

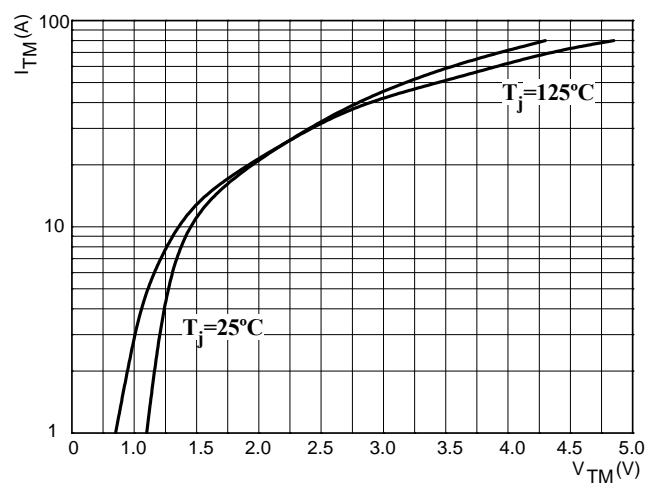

FIG.5: Non-repetitive surge peak on-state current for a sinusoidal pulse with width  $t_p < 10ms$

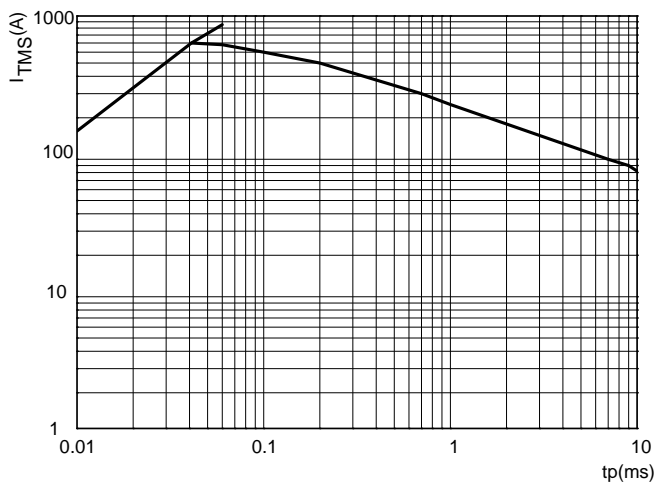
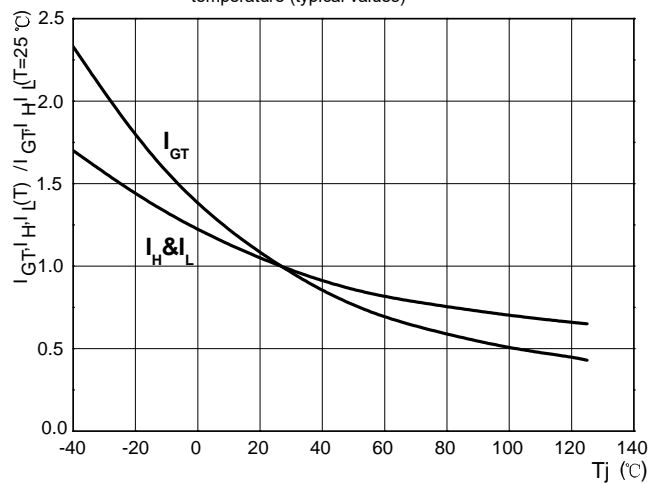

FIG.6: Relative variations of gate trigger current, holding current and latching current versus junction temperature (typical values)



单击下面可查看定价，库存，交付和生命周期等信息

[>>ZG\(中鑫半导体\)](#)