

BT153-800R

MAIN FEATURES

Symbol	Value	Unit
$I_{T(RMS)}$	16	A
V_{DRM}/V_{RRM}	800R	V

DESCRIPTION:

With high ability to withstand the shock loading of large current, BT153-800R of silicon controlled rectifiers provides high dV/dt rate with strong resistance to electromagnetic interference. It is especially recommended for use on solid state relay, motorcycle, power charger, T-tools etc. From all three terminals to external heatsink.

Package TO-220AB is RoHS compliant.

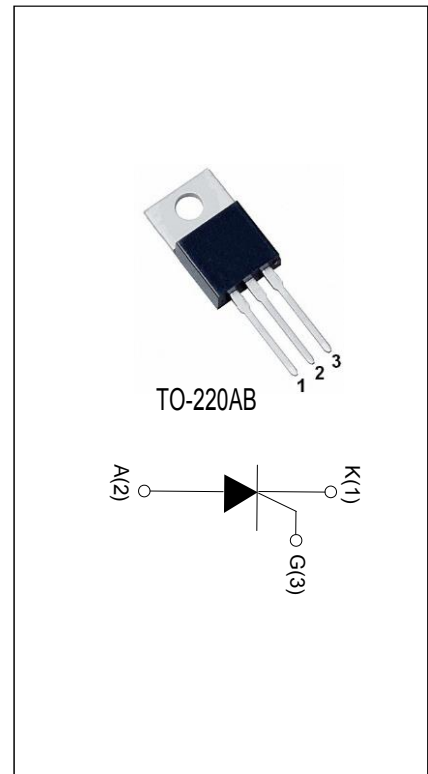

ABSOLUTE MAXIMUM RATINGS

Parameter	Symbol	Value	Unit
Storage junction temperature range	T_{stg}	-40-150	$^{\circ}C$
Operating junction temperature range	T_j	-40-125	$^{\circ}C$
Repetitive peak off-state voltage ($T_j=25^{\circ}C$)	V_{DRM}	800	V
Repetitive peak reverse voltage ($T_j=25^{\circ}C$)	V_{RRM}	800	V
RMS on-state current ($T_c \leq 80^{\circ}C$)	$I_{T(RMS)}$	16	A
Non repetitive surge peak on-state current (full cycle, $t_p=20ms$, $T_j=25^{\circ}C$)	I_{TSM}	160	A
I^2t value for fusing ($t_p=10ms$, $T_j=25^{\circ}C$)	I^2t	128	A^2s
Critical rate of rise of on-state current ($T_j=125^{\circ}C$)	di/dt	50	$A/\mu s$
Peak gate current ($t_p=20\mu s$, $T_j=125^{\circ}C$)	I_{GM}	4	A
Average gate power dissipation ($T_j=125^{\circ}C$)	$P_{G(AV)}$	1	W

ELECTRICAL CHARACTERISTICS ($T_j=25^{\circ}\text{C}$ unless otherwise specified)

Symbol	Test Condition	Value		Unit
I_{GT}	$V_D = 12\text{V}$ $R_L = 100\Omega$	MAX.	20	mA
V_{GT}		MAX.	1.5	V
V_{GD}	$V_D = V_{DRM}$ $T_j = 125^{\circ}\text{C}$ $R_L = 100\Omega$	MIN.	0.2	V
I_L	$I_G = 1.2I_{GT}$	MAX.	60	mA
			100	
I_H	$I_T = 500\text{mA}$	MAX.	30	mA
dV/dt	$V_D = 2/3V_{DRM}$ $T_j = 125^{\circ}\text{C}$	MIN.	500	V/ μs

STATIC CHARACTERISTICS

Symbol	Parameter		Value(MAX.)	Unit
V_{TM}	$I_{TM} = 32\text{A}$	$T_j = 25^{\circ}\text{C}$	1.5	V
V_{TO}	Threshold voltage	$T_j = 125^{\circ}\text{C}$	0.86	V
R_D	Dynamic resistance	$T_j = 125^{\circ}\text{C}$	36.6	$\text{m}\Omega$
I_{DRM}	$V_D = V_{DRM}$ $V_R = V_{RRM}$	$T_j = 25^{\circ}\text{C}$	5	μA
I_{RRM}		$T_j = 125^{\circ}\text{C}$	1	mA

THERMAL RESISTANCES

Symbol	Parameter	Value	Unit
$R_{th(j-c)}$	junction to case (AC)	1.25	$^{\circ}\text{C}/\text{W}$

ORDERING INFORMATION

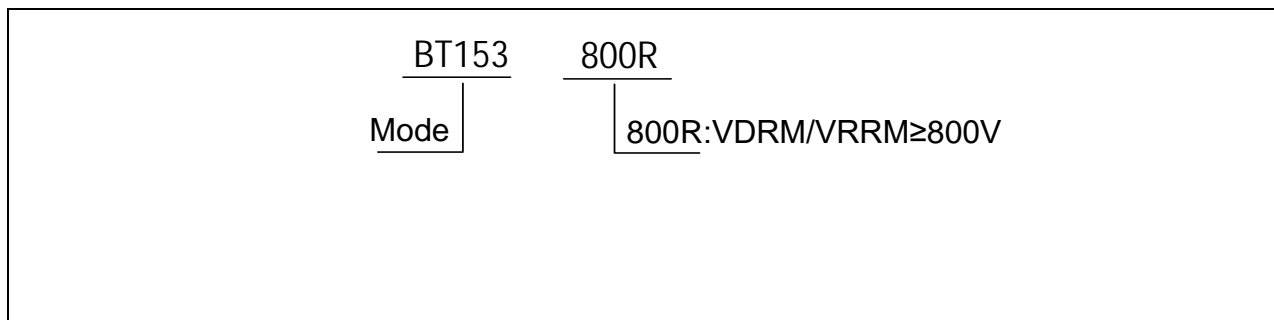

MARKING

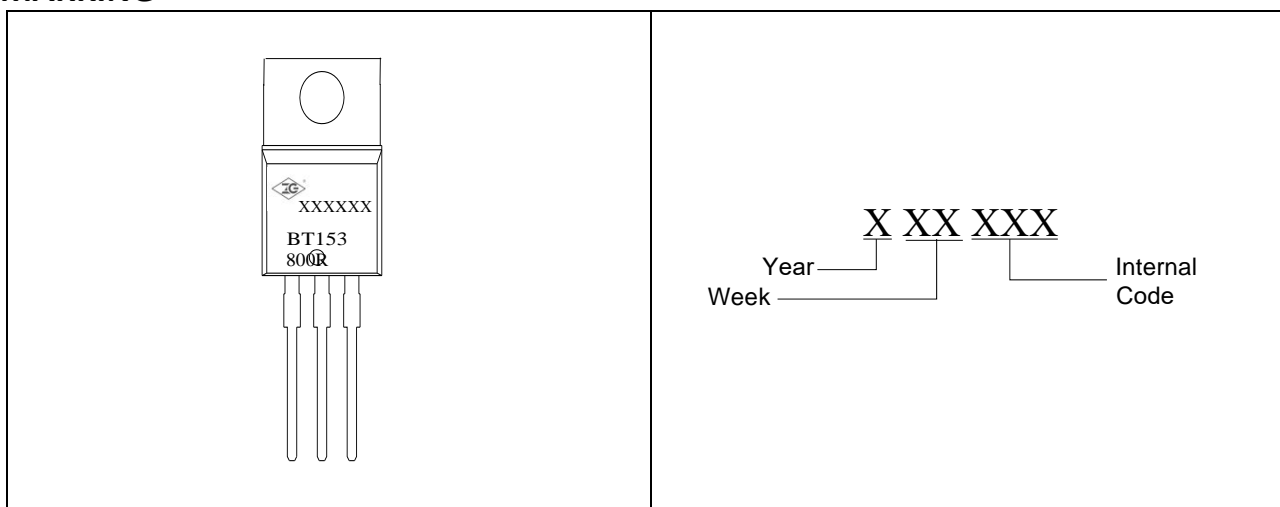

ORDERING INFORMATION

Order code	Voltage V _{DRM} /V _{R_{RRM}} (V)	Package	Base qty. (pcs)	Delivery mode
BT153-800R	800	TO-220AB	50	Tube

PACKAGE MECHANICAL DATA

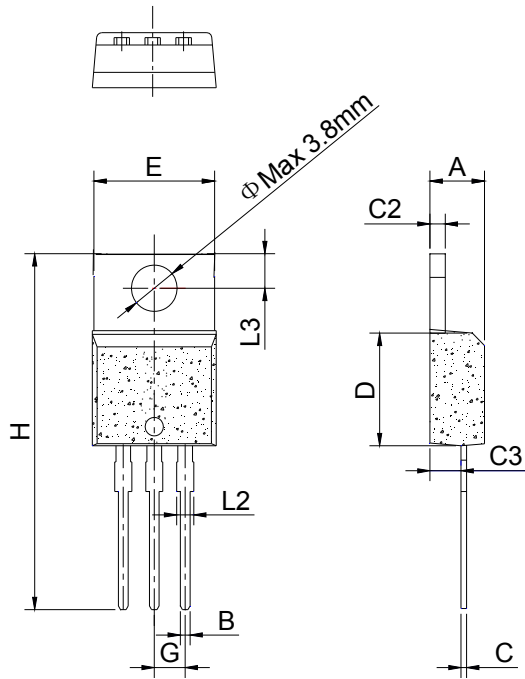

TO-220AB

Ref.	Dimensions		
	Millimeters		
	Min.	Typ.	Max.
A	4.30	4.50	4.70
B	0.60	0.80	1.00
C	0.28	0.38	0.48
C2	1.17	1.27	1.37
C3	2.30	2.50	2.70
D	8.80	9.00	9.20
E	9.80	10.00	10.20
G	2.44	2.54	2.64
H	28.55	28.85	29.15
L2	1.10	1.30	1.50
L3	2.59	2.74	2.89

DELIVERY MODE

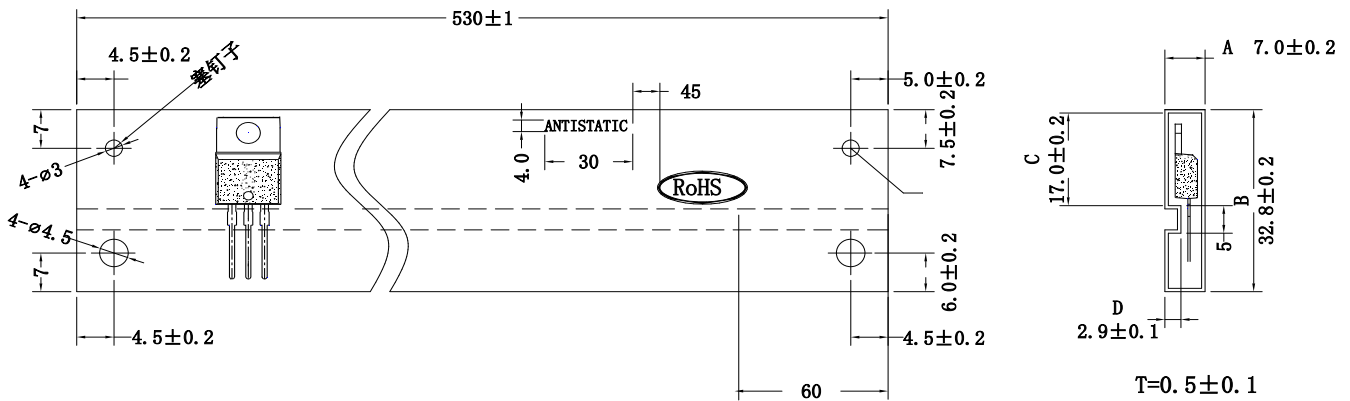

PACKAGE	OUTLINE	TUBE (PCS)	INNER BOX (PCS)	PER CARTON
TO-220AB	TUBE	50	1,000	5,000

FIG.1: Maximum power dissipation versus RMS on-state current (full cycle)

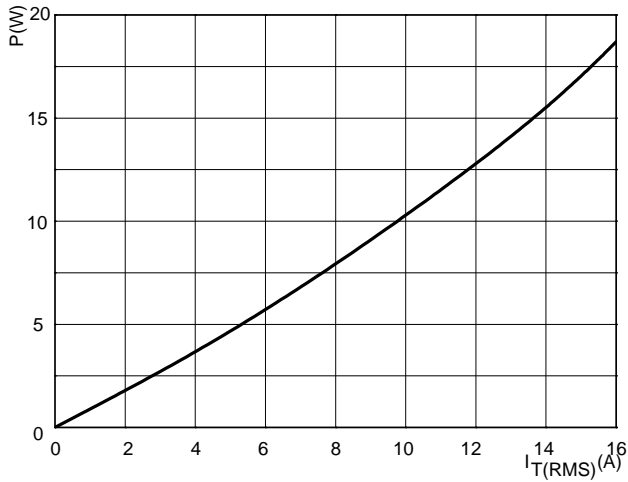

FIG.2: RMS on-state current versus case temperature (full cycle)

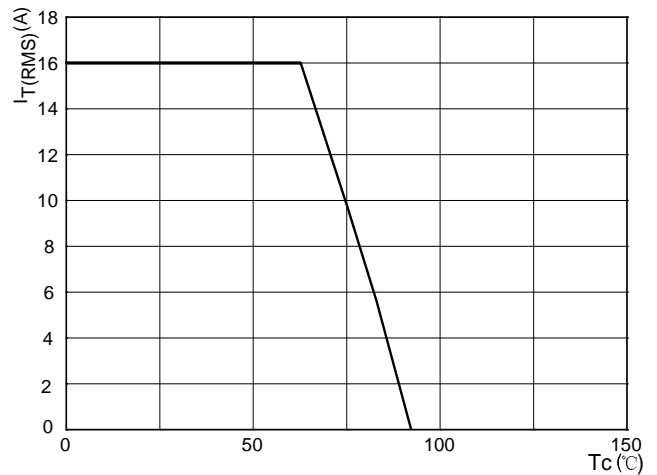

FIG.3: Surge peak on-state current versus number of cycles

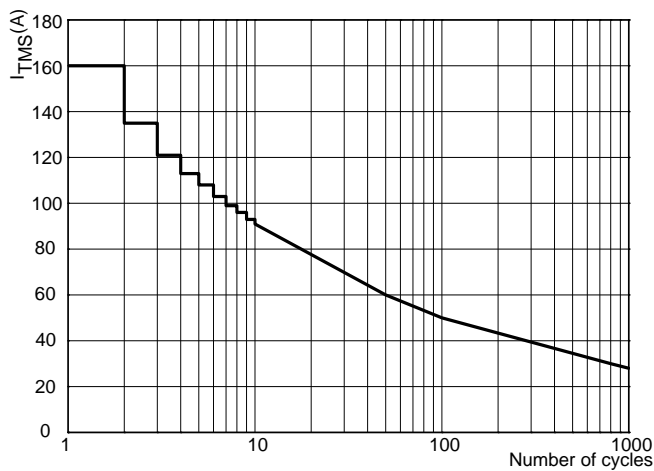

FIG.4: On-state characteristics (maximum values)

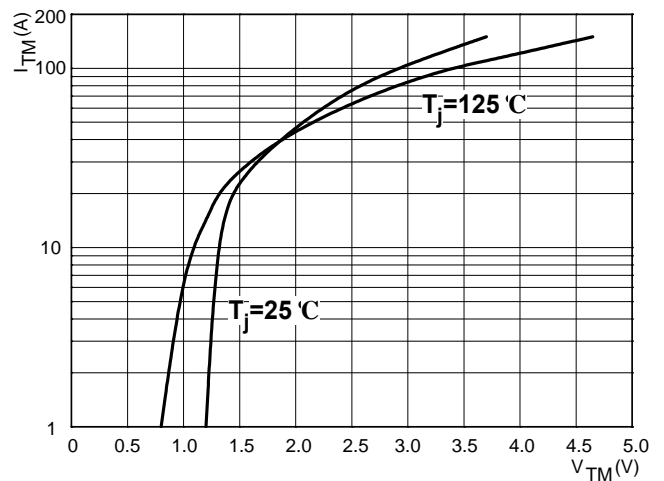

FIG.5: Non-repetitive surge peak on-state current for a sinusoidal pulse with width $t_p < 10\text{ms}$

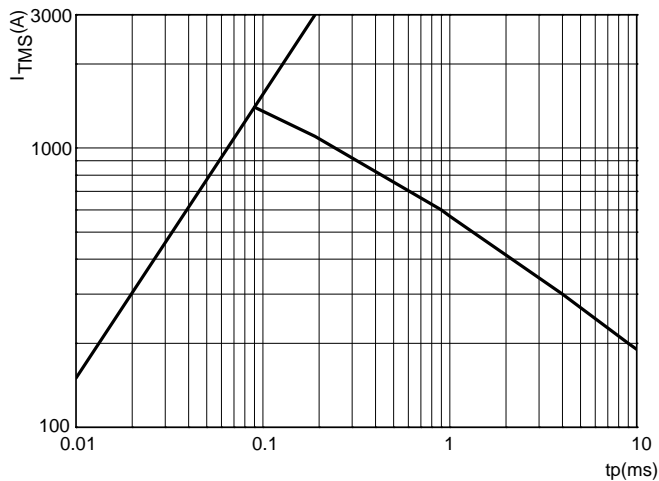
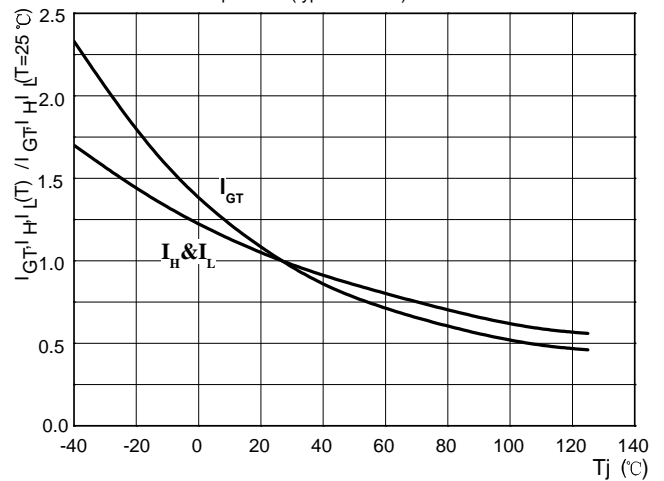

FIG.6: Relative variations of gate trigger current, holding current and latching current versus junction temperature (typical values)



单击下面可查看定价，库存，交付和生命周期等信息

[>>ZG\(中鑫半导体\)](#)