

BTA24-800C
MAIN FEATURES 4Q TRIAC

Symbol	Value	Unit
$I_{T(RMS)}$	24	A
V_{DRM}/V_{RRM}	800	V
$I_{GT1/2/3}$	25/25/25/50	mA

DESCRIPTION:

The BTA24-800C triac is suitable for general purpose AC switching. It can be used as an ON/OFF function in applications such as heating regulation, induction motor starting circuits, for phase control operation in light dimmers, motor speed controllers.

By using an external plastic package.

Package TO-220F is RoHS compliant.

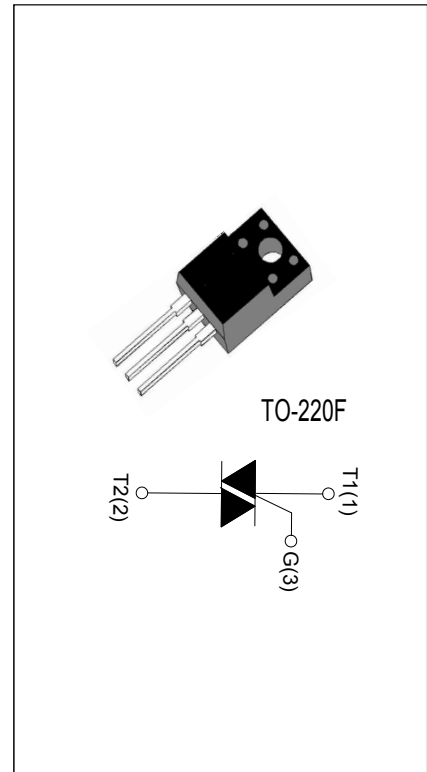
ABSOLUTE MAXIMUM RATINGS

Parameter	Symbol	Value	Unit
Storage junction temperature range	T_{stg}	-40-150	°C
Operating junction temperature range	T_j	-40-125	°C
Repetitive peak off-state voltage ($T_j=25^\circ\text{C}$)	V_{DRM}	800	V
Repetitive peak reverse voltage ($T_j=25^\circ\text{C}$)	V_{RRM}	800	V
RMS on-state current ($T_c \leq 90^\circ\text{C}$)	$I_{T(RMS)}$	24	A
Non repetitive surge peak on-state current (full cycle , $t_p=20\text{ms}$, $T_j=25^\circ\text{C}$)	I_{TSM}	240	A
I^2t value for fusing ($t_p=10\text{ms}$, $T_j=25^\circ\text{C}$)	I^2t	288	A^2s
Critical rate of rise of on-state current ($T_j=125^\circ\text{C}$)	di/dt	50	$\text{A}/\mu\text{s}$
Peak gate current ($t_p=20\mu\text{s}$, $T_j=125^\circ\text{C}$)	I_{GM}	4	A
Average gate power dissipation ($T_j=125^\circ\text{C}$)	$P_{G(AV)}$	1	W

ELECTRICAL CHARACTERISTICS ($T_j=25^\circ\text{C}$ unless otherwise specified)

Symbol	Test Condition	Quadrant	Value		Unit
I_{GT}	$V_D=12\text{V}$ $R_L=100\Omega$	I - II - III	MAX.	25	mA
		IV		50	
V_{GT}		ALL	MAX.	1	V
V_{GD}	$V_D=V_{DRM}$ $T_j=125^\circ\text{C}$ $R_L=100\Omega$	ALL	MIN.	0.2	V
I_L	$I_G=1.2I_{GT}$	I - III - IV	MAX.	80	mA
		II		100	
I_H	$I_T=500\text{mA}$		MAX.	80	mA
dV/dt	$V_D=2/3V_{DRM}$ $T_j=125^\circ\text{C}$		MIN.	500	V/ μs
$(dI/dt)_c$	$T_j=125^\circ\text{C}$		MIN.	10	A/ms

STATIC CHARACTERISTICS

Symbol	Parameter		Value(MAX.)	Unit
V_{TM}	$I_{TM}=32\text{A}$	$T_j=25^\circ\text{C}$	1.55	V
V_{TO}	Threshold voltage	$T_j=125^\circ\text{C}$	0.87	V
R_D	Dynamic resistance	$T_j=125^\circ\text{C}$	14.6	$\text{m}\Omega$
I_{DRM}	$V_D=V_{DRM}$ $V_R=V_{RRM}$	$T_j=25^\circ\text{C}$	5	μA
I_{RRM}		$T_j=125^\circ\text{C}$	1	mA

THERMAL RESISTANCES

Symbol	Parameter	Value	Unit
$R_{th(j-c)}$	junction to case (AC)	2.05	$^\circ\text{C}/\text{W}$

ORDERING INFORMATION

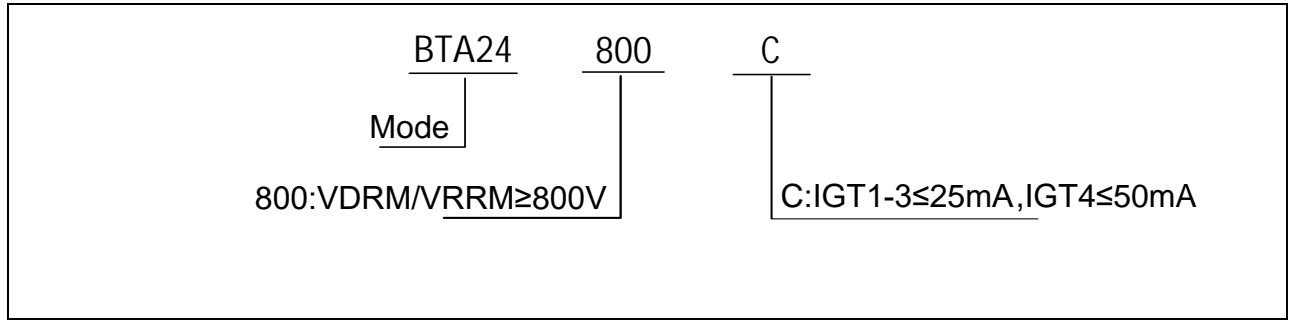

MARKING

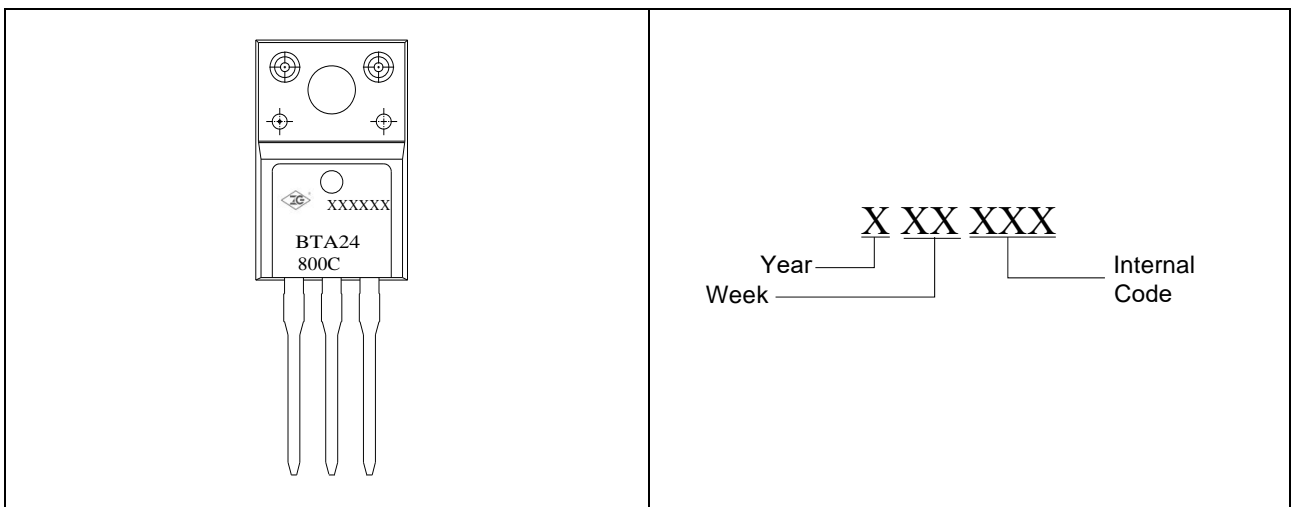

ORDERING INFORMATION

Order code	Voltage V _{DRM} /V _{RRM} (V)	IGT(mA)		Package	Base qty. (pcs)	Delivery mode
		I - II - III	IV			
BTA24-800C	800	25	50	TO-220F	50	Tube

PACKAGE MECHANICAL DATA

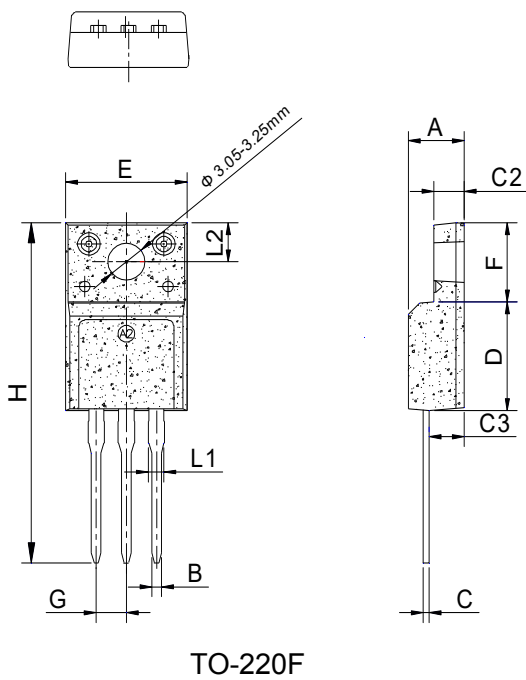

Ref.	Dimensions		
	Millimeters		
	Min.	Typ.	Max.
A	4.50	4.70	4.90
B	0.60	0.80	1.00
C	0.40	0.5	0.60
C2	2.35	2.55	2.75
C3	2.15	2.35	2.55
D	8.97	9.17	9.37
E	9.96	10.16	10.36
F	6.48	6.68	6.88
G	2.44	2.54	2.64
H	28.65	28.95	29.25
L1	1.10	1.30	1.50
L2	3.15	3.30	3.45

DELIVERY MODE

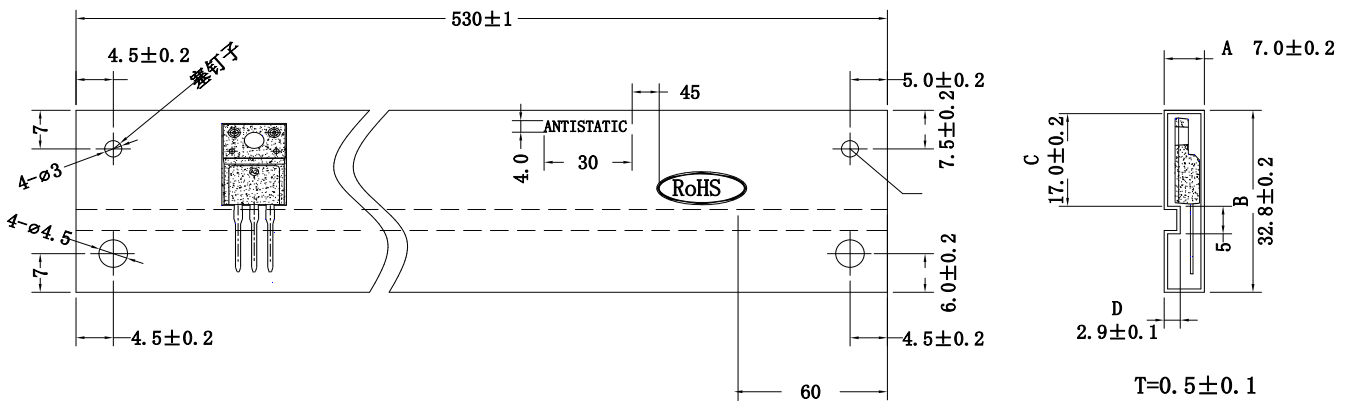

PACKAGE	OUTLINE	TUBE (PCS)	INNER BOX (PCS)	PER CARTON
TO-220F	TUBE	50	1,000	5,000

FIG.1 Maximum power dissipation versus RMS on-state current

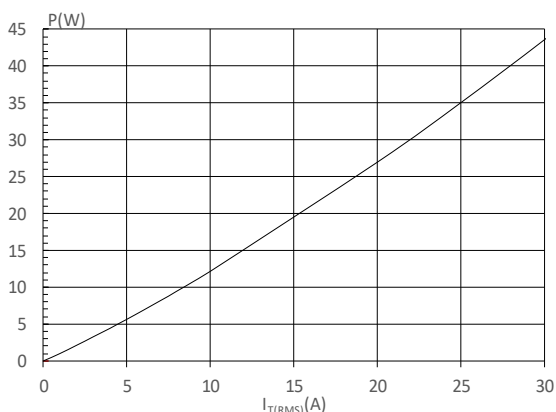

FIG.3: Surge peak on-state current versus number of cycles

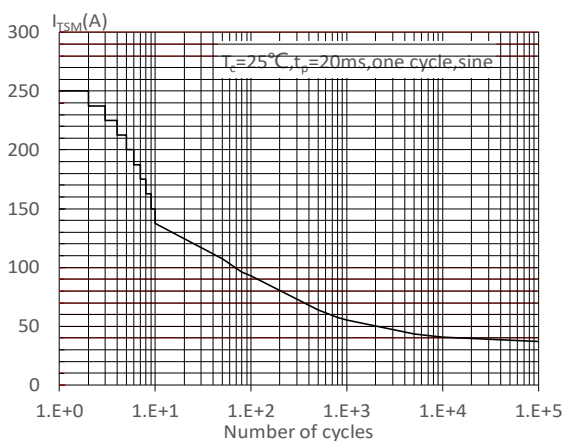

FIG.5: Non-repetitive surge peak on-state current for a sinusoidal pulse with width $t_p < 20\text{ms}$, and corresponding value of I^2t (I - II: $di/dt < 80\text{A}/\mu\text{s}$; III-IV: $di/dt < 40\text{A}/\mu\text{s}$)

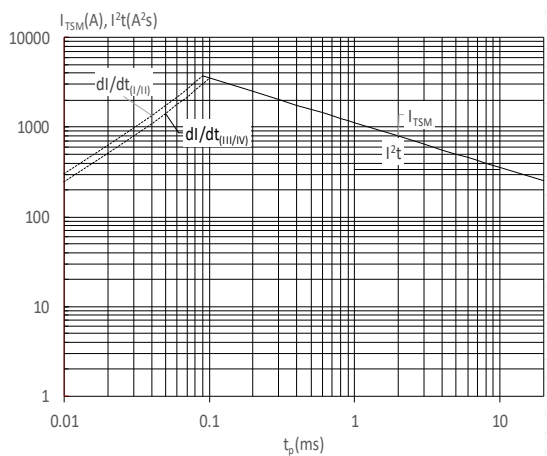

FIG.2: RMS on-state current versus case temperature

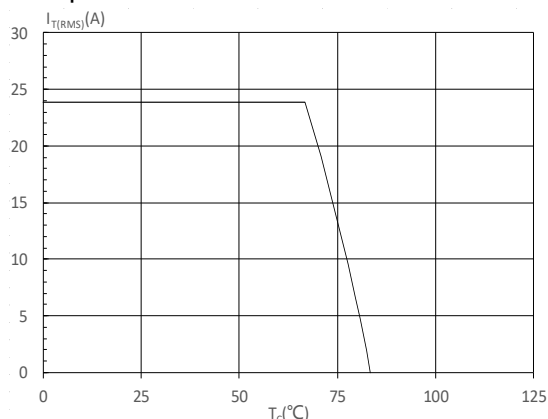

FIG.4: On-state characteristics

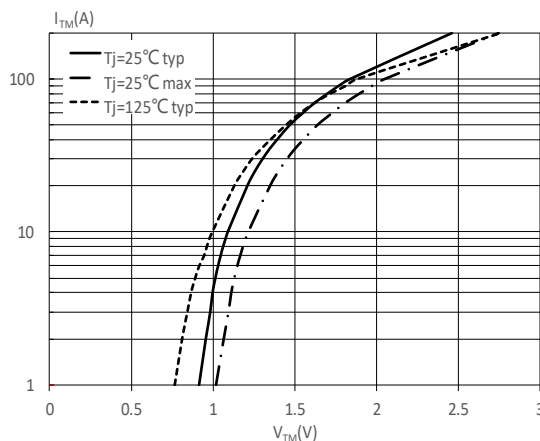
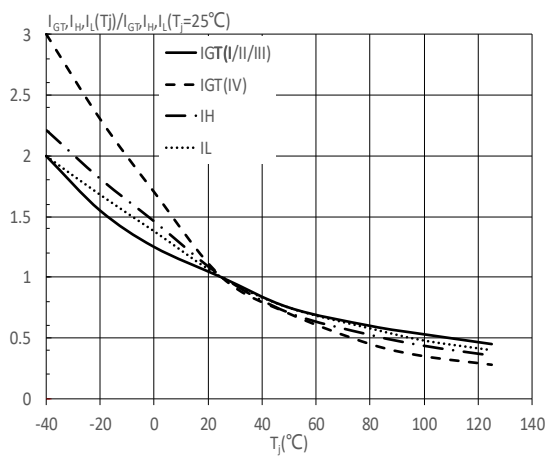

FIG.6: Relative variations of gate trigger current, holding current and latching current versus junction temperature



单击下面可查看定价，库存，交付和生命周期等信息

[>>ZG\(中鑫半导体\)](#)