

## General Purpose Thin Film Chip Resistor — TR Series

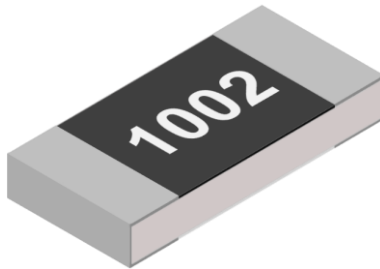

Top view

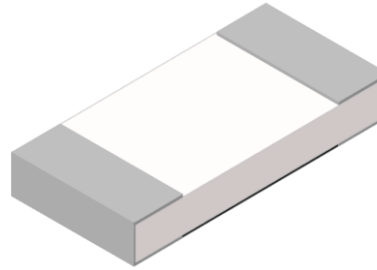

Bottom view

### Applications

- Computer & relative products
- Communication devices
- Measuring instrument
- Converters
- Printing equipment

### Features

- Tolerance to  $\pm 0.1\%$
- Low TCR to  $\pm 10 \text{ ppm}/^\circ\text{C}$
- Down size to 0201
- Halogen free and lead free
- RoHS compliant

### Parts Number Explanation

#### Example:

TR	1206	B	10K0	P	05	25	Z
Product Type	Size (Inch)	Tolerance	Resistance	Package	Quantity (PCS)	TCR (ppm/ $^\circ\text{C}$ )	Optional
TR Series General Purpose Thin Film Chip Resistor	0201 0402 0603 0805 1206 1210 2010 2512	B : $\pm 0.1\%$ C : $\pm 0.25\%$ D : $\pm 0.5\%$ F : $\pm 1\%$	4 digits EX. 1R00 = 1 $\Omega$ 10R0 = 10 $\Omega$ 100R = 100 $\Omega$ 2K20 = 2.2 K $\Omega$ 332K = 332 K $\Omega$ 1M00 = 1 M $\Omega$	P : Paper Taping (0603~1210) Q : Paper Taping (0201、0402) E : Embossed Taping B : Bulk	04 : 4000 05 : 5000 10 : 10000 20 : 20000 40 : 40000 50 : 50000	10 : $\pm 10$ 15 : $\pm 15$ 25 : $\pm 25$ 50 : $\pm 50$	Z : Default Code



# TR Series General Purpose Thin Film Chip Resistor Product Specifications

Document No. S-10-12-03-09

Revision Date 2023/09/08

Page No. 2/9

## Standard Electrical Specifications

項目 Item 型別 Type	額定功率 Rated Power at 70°C	最大工作電壓 Max Working Voltage	最大過負載電壓 Max Overload Voltage	溫度係數 T.C.R. (PPM/°C)	阻值範圍 Resistance Range						
					B ±0.1%	C ±0.25%	D ±0.5%	F ±1%			
TR0201	0.05W	25V	50V	±10	10 Ω ~ 5.1 KΩ						
				±15							
				±25	10 Ω ~ 82 KΩ						
				±50							
TR0402	0.063W	50V	100V	±10	10 Ω ~ 68 KΩ						
				±15							
				±25	4.7 Ω ~ 220 KΩ	2.49 Ω ~ 220 KΩ					
				±50							
TR0603	0.1W	75V	150V	±10	10 Ω ~ 332 KΩ						
				±15							
				±25	4.7 Ω ~ 680 KΩ	2.49 Ω ~ 680 KΩ					
				±50							
TR0805	0.125W	150V	300V	±10	10 Ω ~ 680 KΩ						
				±15							
				±25	4.7 Ω ~ 1 MΩ	2.49 Ω ~ 1 MΩ					
				±50							
TR1206	0.25W	200V	400V	±10	10 Ω ~ 1 MΩ						
				±15							
				±25	4.7 Ω ~ 1.5 MΩ	2.49 Ω ~ 1.5 MΩ					
				±50							
TR1210	0.25W			200V	400V	±10	10 Ω ~ 1 MΩ				
						±15					
						±25	4.7 Ω ~ 1 MΩ	2.49 Ω ~ 1 MΩ			
						±50					
TR2010	0.5W	200V	400V			±10	10 Ω ~ 1 MΩ				
						±15					
						±25	4.7 Ω ~ 1 MΩ	2.49 Ω ~ 1 MΩ			
						±50					
TR2512	0.75W			200V	400V	±10	10 Ω ~ 1 MΩ				
						±15					
						±25	4.7 Ω ~ 1 MΩ	2.49 Ω ~ 1 MΩ			
						±50					

- For non-standard parts, please contact our sales dept.
- Operating Temperature Range : -55°C ~ +155°C.

## Construction

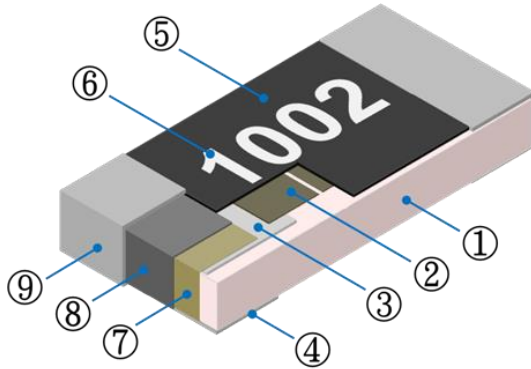

①	Alumina Substrate	④	Bottom Inner Electrode	⑦	Side Inner Electrode
②	Resistive Layer	⑤	Protective Overcoat	⑧	Nickel Barrier
③	Top Inner Electrode	⑥	Marking	⑨	Solder coating (Sn)

## Dimensions

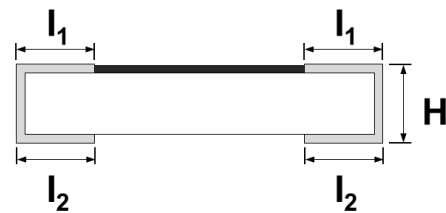
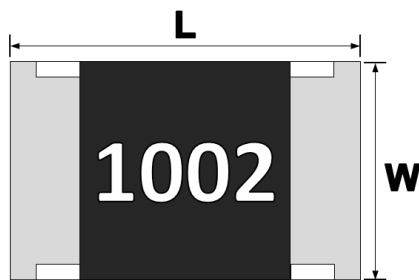

Unit : mm

TYPE	L	W	H	l <sub>1</sub>	l <sub>2</sub>
TR0201	0.60 ± 0.05	0.30 ± 0.05	0.23 ± 0.05	0.12 ± 0.05	0.15 ± 0.05
TR0402	1.00 ± 0.10	0.50 ± 0.05	0.30 ± 0.05	0.20 ± 0.10	0.20 ± 0.10
TR0603	1.60 ± 0.15	0.80 ± 0.10	0.45 ± 0.10	0.30 ± 0.20	0.30 ± 0.20
TR0805	2.00 ± 0.15	1.25 ± 0.15	0.55 ± 0.10	0.35 ± 0.20	0.40 ± 0.20
TR1206	3.10 ± 0.15	1.60 ± 0.15	0.55 ± 0.10	0.45 ± 0.20	0.50 ± 0.20
TR1210	3.10 ± 0.15	2.50 ± 0.15	0.55 ± 0.10	0.45 ± 0.20	0.50 ± 0.20
TR2010	5.00 ± 0.15	2.50 ± 0.15	0.55 ± 0.10	0.60 ± 0.20	0.60 ± 0.20
TR2512	6.30 ± 0.15	3.20 ± 0.15	0.55 ± 0.10	0.60 ± 0.20	0.60 ± 0.20



## ■ Performance Characteristics

### ■ Power Derating Curve

The Operating Temperature Range: -55°C ~+155°C.

Power rating is in the case based on continuous full-load at ambient temperature of 70°C. For operation at ambient temperature in excess of 70°C, the load should be derated in accordance with figure of derating Curve.

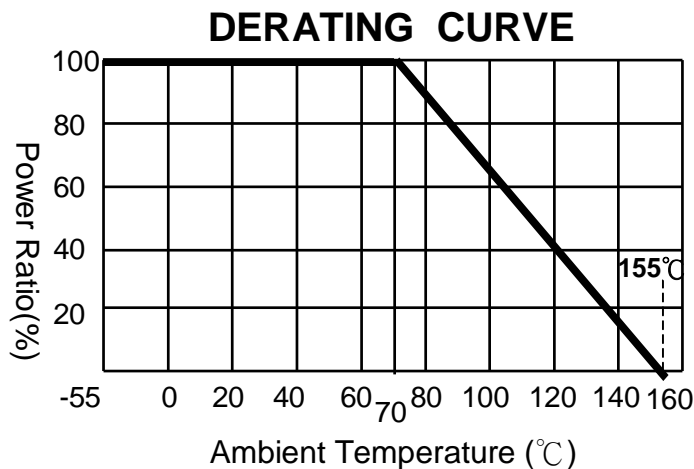

### ■ Rated Voltage

Resistance Range:  $\geq 1\Omega$

Rated Voltage: The resistor shall have a DC continuous working voltage or a RMS AC continuous working voltage at commercial-line frequency and wave form corresponding to the power rating, as determined formula as following:

$$V = \sqrt{P \times R}$$

V = Rated voltage (V)

P = Rated power (W)

R = Nominal resistance ( $\Omega$ )



# TR Series General Purpose Thin Film Chip Resistor Product Specifications

Document No. S-10-12-03-09

Revision Date 2023/09/08

Page No. 5/9

## Reliability Tests and Requirements

Test Item	Test Method	Procedure	Requirements
Temperature Coefficient of Resistance (T.C.R)	JIS-C-5201-1 4.8 IEC-60115-1 4.8	At 25 / -55°C and 25°C /+125°C, 25°C is the reference temperature	Refer to Standard Electrical Specifications
Short Time Overload	JIS-C-5201-1 4.13 IEC-60115-1 4.13	2.5 times RCWV or Max. Overload voltage whichever is less for 5 seconds.	±(0.5%+0.05Ω) No Visual damage
Insulation Resistance	JIS-C-5201-1 4.6 IEC-60115-1 4.6	Apply 100VDC for 1 minute.	≥ 10GΩ
Solderability	JIS-C-5201-1 4.17 IEC-60115-1 4.17	245±5°C for 3 seconds.	>95% Coverage No Visual damage
Resistance to Soldering Heat	JIS-C-5201-1 4.18 IEC-60115-1 4.18	260±5°C for 10 seconds.	±(0.5%+0.05Ω) No Visual damage
Leaching	JIS-C-5201-1 4.18 IEC-60068-2-58 8.2.1	260±5°C for 30 seconds.	>95% Coverage No Visual damage
Rapid Change of Temperature	JIS-C-5201-1 4.19 IEC-60115-1 4.19	-55°C to +155°C, 300 cycles	±(0.5%+0.05Ω) No Visual damage
High Temperature Exposure	JIS-C5201-1 4.25 IEC 60068-2-2	At 155±5°C for 1000 hours.	±(0.5%+0.05Ω)
Resistance to Solvent	JIS-C-5201-1 4.29	The tested resistor be immersed into isopropyl alcohol of 20~25°C for 60 secs. Then the resistor is left in the room for 48 hrs.	±(0.5%+0.05Ω) No Visual damage
Damp Heat with Load	JIS-C-5201-1 4.24 IEC-60115-1 4.24	40±2°C, 90~95% R.H. RCWV or Max. working voltage whichever is less for 1000 hrs with 1.5 hrs "ON" and 0.5 hr "OFF"	±(0.5%+0.05Ω)
Biased Humidity	MIL-STD-202 Method 103	1,000 hours; 85°C / 85% RH, 10% of operating power. Measurement at 24±4 hours after test conclusion.	±(0.5%+0.05Ω)
Load Life (Endurance)	JIS-C-5201-1 4.25 IEC-60115-1 4.25.1	70±2°C, RCWV or Max. working voltage whichever is less for 1000 hrs with 1.5 hrs "ON" and 0.5 hr "OFF" .	±(0.5%+0.05Ω)
Bending Strength	JIS-C-5201-1 4.33 IEC-60115-1 4.33	Bending once for 5 seconds D : 0201、0402、0603、0805 = 5mm 1206、1210 = 3mm 2010、2512 = 2mm	±(0.5%+0.05Ω) No Visual damage

• We can also provide AEC-Q200 test reports if required by customers.

■ **Recommended Customer Soldering Parameters**

■ **Wave solder Temperature condition**

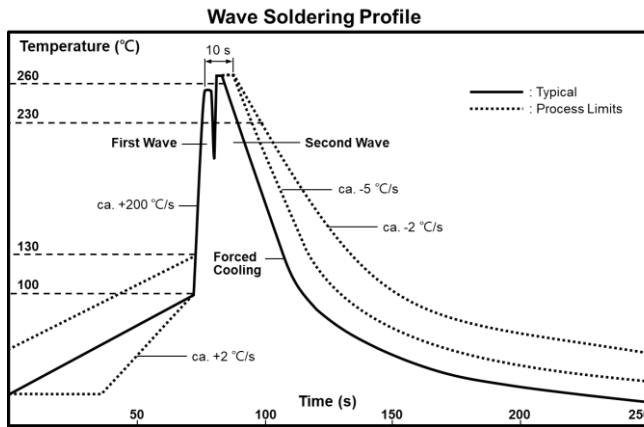

■ **Solder reflow Temperature condition**

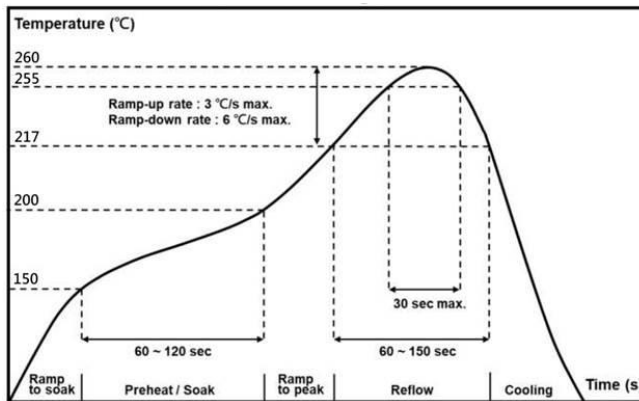

· The peak temperature of soldering heat is 260 for 10s

■ **Rework temperature ( hot air equipment ) : 350°C, 3~5seconds**

■ **Recommended reflow methods**

IR, vapor phase oven, hot air oven

If reflow temperatures exceed the recommended profile, devices may not meet the performance requirements.

■ **Recommend Land Pattern Design**

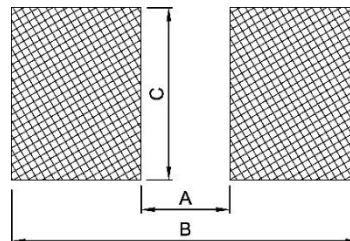

Unit: mm

Type	0201	0402	0603	0805	1206	1210	2010	2512
A	0.25	0.50	0.80	1.30	2.20	2.00	3.80	4.90
B	0.85	1.60	2.40	2.90	4.20	4.40	6.60	8.10
C	0.35	0.70	1.00	1.40	1.70	2.70	2.70	3.40

**Marking**



0201 ~ 0402: no marking



0603: 3 digits code



0805~2512: 4 digits code

**No marking on 0201/0402 type**

**3 digits code for 0603 type**

**Standard E96 Values and 0603 Resistance Codes**

<b>R-Value</b>	100	102	105	107	110	113	115	118	121	124	127	130	133	137	140	143	147	150	154	158	162	165	169	174
<b>Code</b>	01	02	03	04	05	06	07	08	09	10	11	12	13	14	15	16	17	18	19	20	21	22	23	24
<b>R-Value</b>	178	182	187	191	196	200	205	210	215	221	226	232	237	243	249	255	261	267	274	280	287	294	301	309
<b>Code</b>	25	26	27	28	29	30	31	32	33	34	35	36	37	38	39	40	41	42	43	44	45	46	47	48
<b>R-Value</b>	316	324	332	340	348	357	365	374	383	392	402	412	422	432	442	453	464	475	487	499	511	523	536	549
<b>Code</b>	49	50	51	52	53	54	55	56	57	58	59	60	61	62	63	64	65	66	67	68	69	70	71	72
<b>R-Value</b>	562	576	590	604	619	634	649	665	681	698	715	732	750	768	787	806	825	845	866	887	909	931	953	976
<b>Code</b>	73	74	75	76	77	78	79	80	81	82	83	84	85	86	87	88	89	90	91	92	93	94	95	96

**E96 Multiplier Code**

Code	A	B	C	D	E	F	G	H	X	Y	Z
Multiplier	10 <sup>0</sup>	10 <sup>1</sup>	10 <sup>2</sup>	10 <sup>3</sup>	10 <sup>4</sup>	10 <sup>5</sup>	10 <sup>6</sup>	10 <sup>7</sup>	10 <sup>-1</sup>	10 <sup>-2</sup>	10 <sup>-3</sup>

1. 0603 3 digits coding formula for E96 values as following:

CODING FORMULA

$$\begin{array}{c} \text{XX} \\ \uparrow \\ \text{Resistance Code} \end{array} \quad \begin{array}{c} \text{X} \\ \swarrow \\ \text{Multiplier Code} \end{array} \quad \text{Example: } 10.2\text{K}\Omega = \underline{102} \times \underline{10^2}\Omega = \mathbf{02C}$$

$$33.2\Omega = \underline{332} \times \underline{10^{-1}}\Omega = \mathbf{51X}$$

$$51 \quad X$$

EX.: 7.5Ω=85Y ; 11Ω=05X ; 130Ω=12A ; 2KΩ= 30B ; 10KΩ=01C ; 150KΩ=18D

E24	10	11	12	13	15	16	18	20	22	24	27	30	33	36	39	43	47	51	56	62	68	75	82	91
-----	----	----	----	----	----	----	----	----	----	----	----	----	----	----	----	----	----	----	----	----	----	----	----	----

2. 0603 3 digits for E24 values

Examples:

Resistance	4.7Ω	33Ω	470Ω	5.6KΩ	62KΩ	680KΩ
3 digits code	4R7	330	471	562	623	684

("R"= decimal point)

3. 0603 E192 values have no marking code.

**4 digits code for 0805 ~ 2512 type**

First 3 digits are the significant figures, the 4th digit is the multiplier. "R"= decimal point.

Examples:

Resistance	5.6Ω	10Ω	22.6Ω	100Ω	1.1KΩ	10KΩ	332KΩ	1MΩ
4 digits code	5R60	10R0	22R6	1000	1101	1002	3323	1004

**■ Packaging Information**

**■ Reel Dimensions**

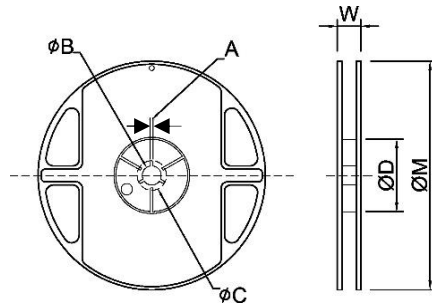

Unit: mm

Type	Size	A	φB	φC	φD	W	φM
0201	7" 10K/Reel	2.0±0.5	13.5±1.0	21±1.0	60±1.0	11.5±2.0	178±2.0
0402	7" 10K/Reel	2.0±0.5	13.5±1.0	21±1.0	60±1.0	11.5±2.0	178±2.0
0402	13" 40K/50K Reel	2.0±0.5	13.5±1.0	21±1.0	100±1.0	11.5±2.0	330±2.0
0603/0805/1206/1210	7" 5K/Reel	2.0±0.5	13.5±1.0	21±1.0	60±1.0	11.5±2.0	178±2.0
0603/0805 /1206	10" 10K/Reel	2.0±0.5	13.5±1.0	21±1.0	100±1.0	11.5±2.0	254±2.0
	13" 20K/Reel	2.0±0.5	13.5±1.0	21±1.0	100±1.0	11.5±2.0	330±2.0
2010/2512	7" 4K/Reel	2.0±0.5	13.5±1.0	21±1.0	60±1.0	16.0±2.0	178±2.0

**■ Paper Tape Dimensions**

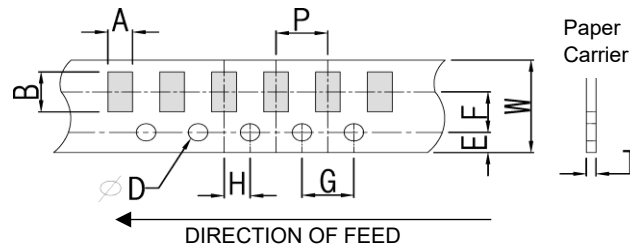

Unit: mm

Type	A	B	W	E	F	G	H	T	φD	P
0201	0.40±0.05	0.70±0.05	8.0±0.20	1.75±0.10	3.5±0.05	4.0±0.10	2.0±0.05	0.45±0.10	1.50 <sup>+0.10</sup> <sub>-0</sub>	2.0±0.10
0402	0.70±0.10	1.20±0.10	8.0±0.20	1.75±0.10	3.5±0.05	4.0±0.10	2.0±0.05	0.45±0.10		
0603	1.05±0.20	1.80±0.20	8.0±0.20	1.75±0.10	3.5±0.05	4.0±0.10	2.0±0.05	0.60±0.10		
0805	1.55±0.20	2.30±0.20	8.0±0.20	1.75±0.10	3.5±0.05	4.0±0.10	2.0±0.05	0.75±0.10		
1206	1.90±0.20	3.50±0.20	8.0±0.20	1.75±0.10	3.5±0.05	4.0±0.10	2.0±0.05	0.75±0.10		
1210	2.85±0.20	3.50±0.20	8.0±0.20	1.75±0.10	3.5±0.05	4.0±0.10	2.0±0.05	0.75±0.10		4.0±0.10

**■ Plastic Embossed Tape Dimensions**

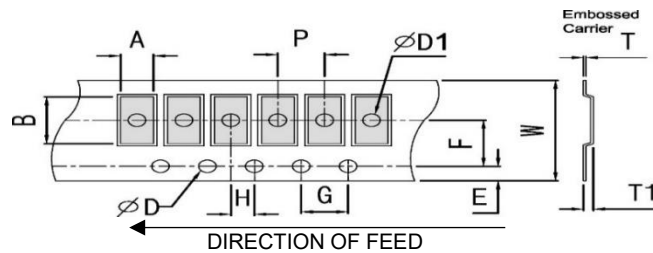

Unit: mm

Type	A	B	W	E	F	G	H	T	φD	φD1	T1	P
2010	2.80±0.20	5.60±0.20	12±0.10	1.75±0.10	5.5±0.05	4.0±0.10	2.0±0.05	0.23±0.10	1.50 <sup>+0.10</sup> <sub>-0</sub>	1.50±0.10	0.85±0.15	4.0±0.10
2512	3.40±0.20	6.70±0.20	12±0.10	1.75±0.10	5.5±0.05	4.0±0.10	2.0±0.05	0.23±0.10		1.50±0.10	0.85±0.15	



■ **Front & Back Lead Dimensions**

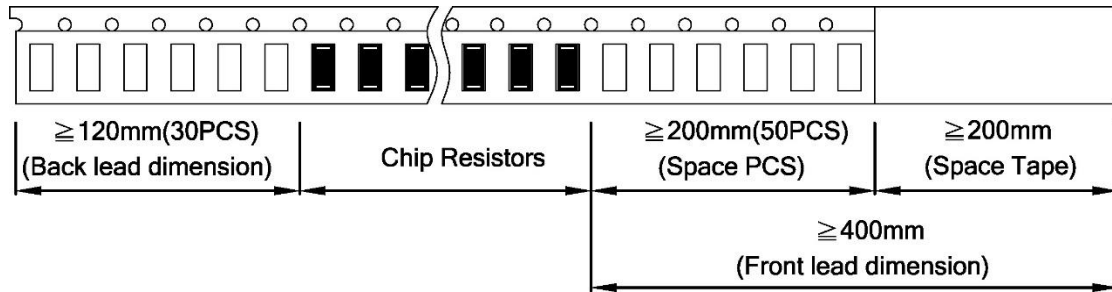

■ **Top Adhesive Peel Off Strength : 10~70g**

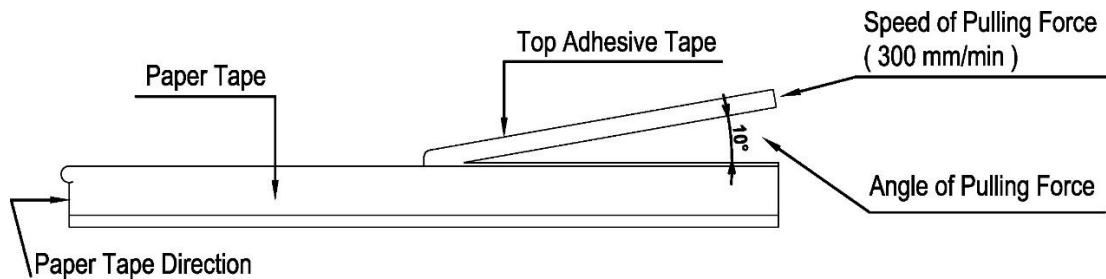

■ **Package**

Inner Box Size	
Reel	Size H(mm)
1	13
2	24
3	36
5	60
10	113

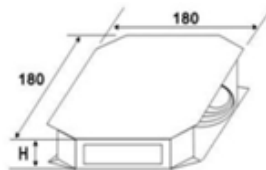

External Box Size			
Contain (Kpcs)	Length (mm)	Width (mm)	Height (mm)
25K	180	180	60
50K	180	180	110
150K	430	200	200
300K	400	400	200

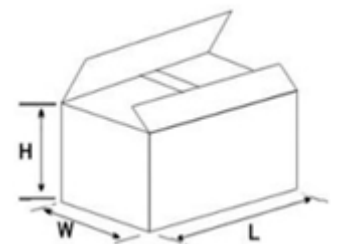

■ **Storage Data :**

Storage time at the environment temp: 25±5°C & humidity: 60±20% is valid for one year from the date of delivery.

单击下面可查看定价，库存，交付和生命周期等信息

[>>EVER OHMS\(天二\)](#)