

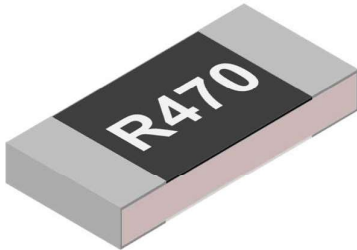

TGL Series Metal Film Anti-Surge Low-Resistance Chip Resistor Product Specifications

Document No.	S-10-12-35-07
Released Date	2020/3/26
Page No.	1/10

■ Metal Film Anti-Surge Low-Resistance Chip Resistor — TGL Series



Top view

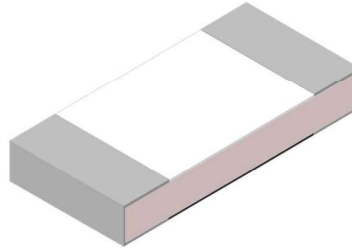

Bottom view

■ Application

- Consumer electronics
- Computer & relative products
- Communication devices
- Measuring instrument
- Industrial / Power supply
- Battery management system

■ Features

- Low Resistance / TCR / Inductance($\leq 5nH$)
- Excellent long-term stability
- High precision current sensing
- High rated power capability and excellent Anti-Surge
- Halogen free and lead free
- RoHs compliant

■ Parts Number Explanation

■ Example:

TGL	1206	10	F	R470	P	05	Z
Product Type	Size (Inch)	Rated Power	Tolerance	Resistance	Package	Quantity (PCS)	Optional
Metal Film Anti-Surge Low-Resistance Chip Resistors	1206 1210 2010 2512	10 : 1.0W 15 : 1.5W 20 : 2.0W 35 : 3.5W	D : $\pm 0.5\%$ F : $\pm 1\%$ G : $\pm 2\%$ J : $\pm 5\%$	EX, R050 = 0.05Ω R470 = 0.47Ω 4R70 = 4.7Ω 33R0 = 33Ω	P : Paper Taping E : Embossed Taping	04 : 4000 05 : 5000	Z : Normal U : Ultra Power



TGL Series Metal Film Anti-Surge Low-Resistance Chip Resistor Product Specifications

Document No.	S-10-12-35-07
Released Date	2020/3/26
Page No.	2/10

Standard Electrical Specifications

Type	Rated Power at 70°C	Max. Rated Current	Max. Overload Current	T.C.R. (ppm/°C)	Resistance Range
					D(0.5%), F(1.0%), G(2.0%), J(5.0%)
TGL1206	1W	4.47A	10.00A	±100	50 mΩ ≤ R < 100 mΩ
TGL1210	1W	4.47A	10.00A	±50	100 mΩ ≤ R ≤ 33 Ω
TGL2010	1.5W	5.48A	12.25A	±50	50 mΩ ≤ R ≤ 33 Ω
TGL2512	2W	6.32A	14.14A		
	3.5W(U)	8.37A	18.71A		

- For non-standard parts, please contact our sales dept.
- Operating Temperature Range : -55°C ~ +170°C.

Anti-Surge Ability:

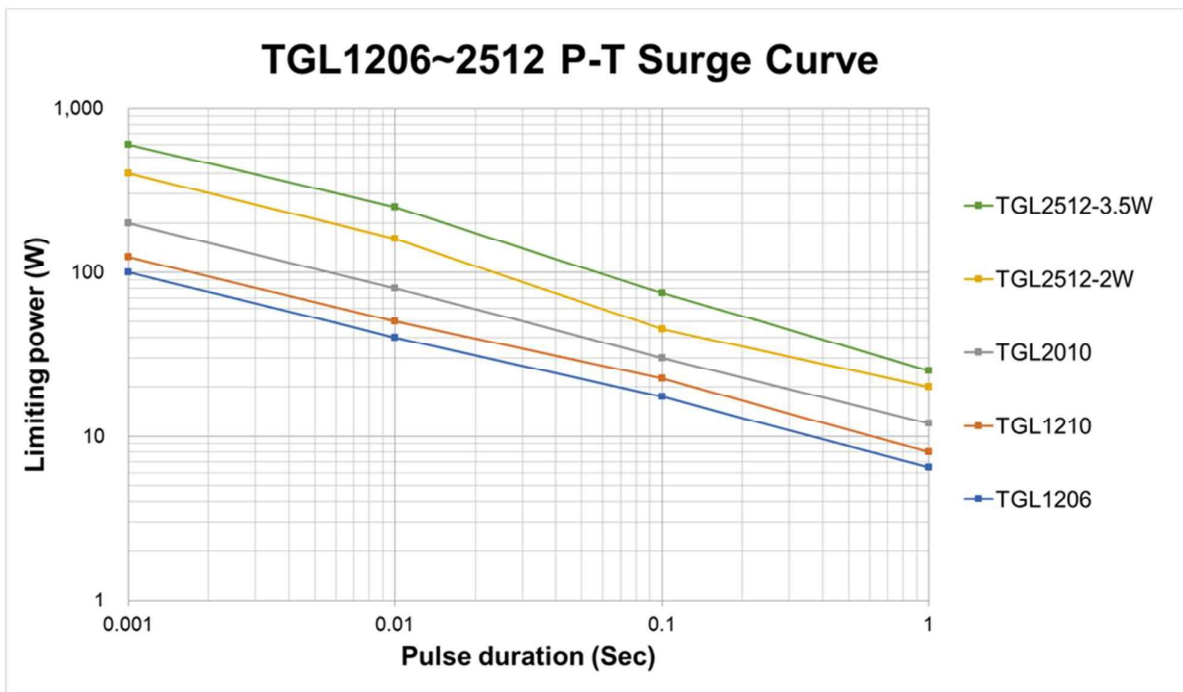



TGL Series Metal Film Anti-Surge Low-Resistance Chip Resistor Product Specifications

Document No.	S-10-12-35-07
Released Date	2020/3/26
Page No.	3/10

■ Type Dimension

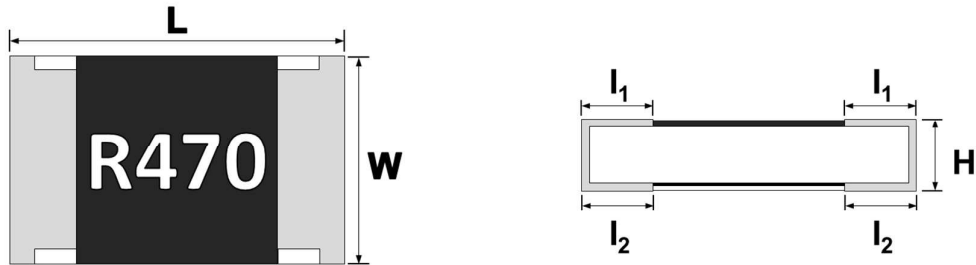

Unit : mm

TYPE	L	W	H	l ₁	l ₂
TGL1206	3.10±0.10	1.60±0.10	0.55±0.10	0.40±0.20	0.45±0.20
TGL1210	3.10±0.10	2.50±0.15	0.55±0.10	0.50±0.20	0.50±0.20
TGL2010	5.00±0.20	2.50±0.15	0.55±0.10	0.60±0.25	0.60±0.25
TGL2512	6.30±0.20	3.20±0.20	0.55±0.10	0.65±0.25	0.65±0.25
TGL2512(U)	6.30±0.20	3.20±0.20	0.70±0.15	0.65±0.25	0.65±0.25

■ Construction

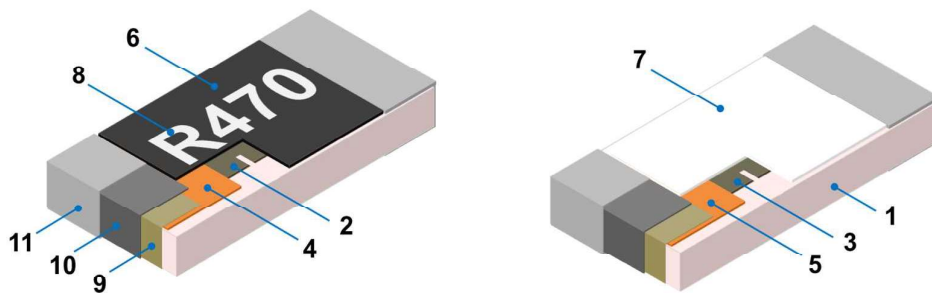

1	Alumina Substrate	7	Bottom Protective Overcoat
2	Top Resistive Layer	8	Marking
3	Bottom Resistive Layer	9	Side Inner Electrode
4	Top Inner Electrode (Cu)	10	Barrier Layer (Ni)
5	Bottom Inner Electrode (Cu)	11	Solder coating (Sn)
6	Top Protective Overcoat		



TGL Series Metal Film Anti-Surge Low-Resistance Chip Resistor Product Specifications

Document No.	S-10-12-35-07
Released Date	2020/3/26
Page No.	4/10

Performance Characteristics

Power Derating Curve

The Operating Temperature Range: $-55^{\circ}\text{C} \sim +170^{\circ}\text{C}$.

Power rating or current rating is in the case based on continuous full-load at ambient temperature of 70°C .

For operation at ambient temperature in excess of 70°C , the load should be derated in accordance with figure of derating Curve.

Derating Curve

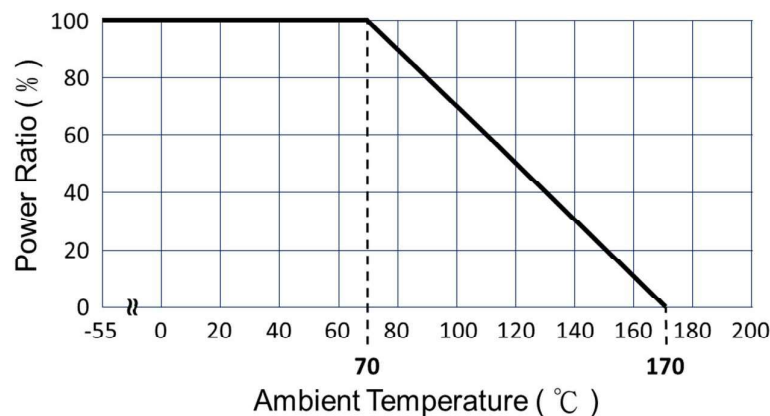

Rated Current

Resistance Range: $< 1\Omega$

Rated Current: The resistor shall have a DC continuous working current or a AC (rms) continuous working current at commercial-line frequency and wave form corresponding to the power rating, as determined formula as following:

$$I = \sqrt{P/R}$$

I = Rated current (A)
P = Rated power (W)
R = Nominal resistance (Ω)

Rated Voltage

Resistance Range: $\geq 1\Omega$

Rated Voltage: The resistor shall have a DC continuous working voltage or a RMS AC continuous working voltage at commercial-line frequency and wave form corresponding to the power rating, as determined formula as following:

$$V = \sqrt{P \times R}$$

V = Rated voltage (V)
P = Rated power (W)
R = Nominal resistance (Ω)



TGL Series Metal Film Anti-Surge Low-Resistance Chip Resistor Product Specifications

Document No.	S-10-12-35-07
Released Date	2020/3/26
Page No.	5/10

Reliability Test and Requirement

Test Item	Test Method	Procedure	Requirements
Temperature Coefficient of Resistance (T.C.R)	JIS-C-5201-1 4.8 IEC-60115-1 4.8	At 25°C / +125°C, 25°C is the reference temperature	Refer to Standard Electrical Specifications
Short Time Overload	JIS-C-5201-1 4.13 IEC-60115-1 4.13	5 times rated power whichever is less for 5 seconds.	±(1.0%+0.001Ω)
Insulation Resistance	JIS-C-5201-1 4.8 IEC-60115-1 4.8	Applied 100VDC for 1 minute.	≥10GΩ
Dielectric Withstanding Voltage	JIS-C5201-1 4.7	Applied 500VAC for 1 minute.	No short or burned on the appearance.
Core Body Strength	JIS-C5201-1 4.15	Central part pressurizing force : 10N , 10 seconds	No broken
Solderability	JIS-C-5201-1 4.17 IEC-60115-1 4.17	245±5°C for 3 seconds.	>95% Coverage No Visual damage
Resistance to Soldering Heat	JIS-C-5201-1 4.18 IEC-60115-1 4.18	260±5°C for 10 seconds.	±(1.0%+0.001Ω) No Visual damage
Leaching	JIS-C-5201-1 4.18 IEC-60068-2-58 8.2.1	260±5°C for 30 seconds.	>95% Coverage No Visual damage
Rapid Change of Temperature	JIS-C-5201-1 4.19 IEC-60115-1 4.19	-55°C to +155°C, 300 cycles	±(1.0%+0.001Ω) No Visual damage
Damp Heat with Load	JIS-C-5201-1 4.24 IEC-60115-1 4.24	40±2°C, 90~95% R.H. RCWV or Max. working current whichever is less for 1000 hrs with 1.5 hrs "ON" and 0.5 hr "OFF"	±(1.0%+0.001Ω)
Biased Humidity	MIL-STD-202 Method 103	1,000 hours; 85°C / 85% RH, 10% of operating power. Measurement at 24±4 hours after test conclusion.	±(0.5%+0.05Ω)
Load Life (Endurance)	JIS-C-5201-1 4.25 IEC-60115-1 4.25.1	70±2°C, Rated power, or Max. working current whichever is less for 1000 hrs with 1.5 hrs "ON" and 0.5 hr "OFF" .	±(1.0%+0.001Ω)
High Temperature Exposure	JIS-C5201-1 4.25 IEC 60068-2-2	At +170±5°C for 1000 +48/-0 hours.	±(1.0%+0.001Ω)
Resistance to Solvent	JIS-C-5201-1 4.29	The tested resistor be immersed into isopropyl alcohol of 20~25°C for 60 secs. Then the resistor is left in the room for 48 hrs.	±(1.0%+0.001Ω) No Visual damage
Terminal Strength (SMD)	JIS-C5201-1 4.32 AEC Q200-006	Pressurizing force for 60 seconds 1206 and above : 17.7N	No broken
Bending Strength	JIS-C-5201-1 4.33 IEC-60115-1 4.33	Bending once for 5 seconds D : 1206、1210 = 3mm 2010、2512 = 2mm	±(1.0%+0.001Ω) No Visual damage

- Temperature Coefficient of Resistance test to - 55 °C is available on request
- We can also provide AEC-Q200 test reports if required by customers.



TGL Series Metal Film Anti-Surge Low-Resistance Chip Resistor Product Specifications

Document No.	S-10-12-35-07
Released Date	2020/3/26
Page No.	6/10

■ Marking

■ TGL1206 ~ TGL2512 : 4 digit marking

First 3 digits are the significant figures, the 4th digit is the multiplier. "R"= decimal point.

Examples:

Resistance value	Code	Example
50 mΩ ~ 99 mΩ	R0XX	R050 = 0.05 Ω
100 mΩ ~ 999 mΩ	RXXX	R470 = 0.47 Ω
1 Ω ~ 9.9 Ω	XRXX	4R70 = 4.7 Ω
10 Ω ~ 33 Ω	XRX	33R0 = 33 Ω

■ Recommended Customer Soldering Parameters

■ Wave solder Temperature condition

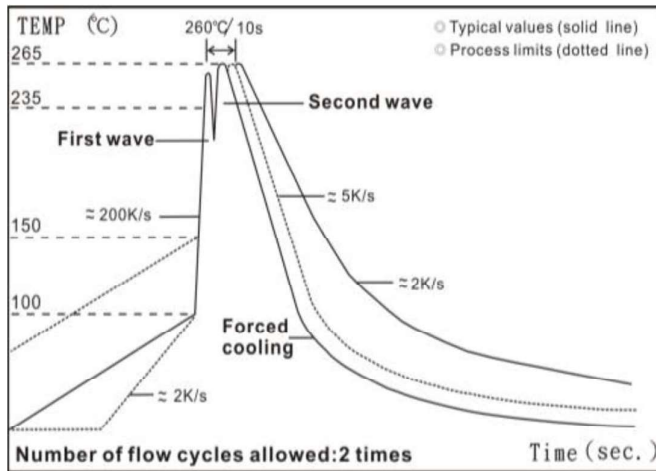

■ Solder reflow Temperature condition

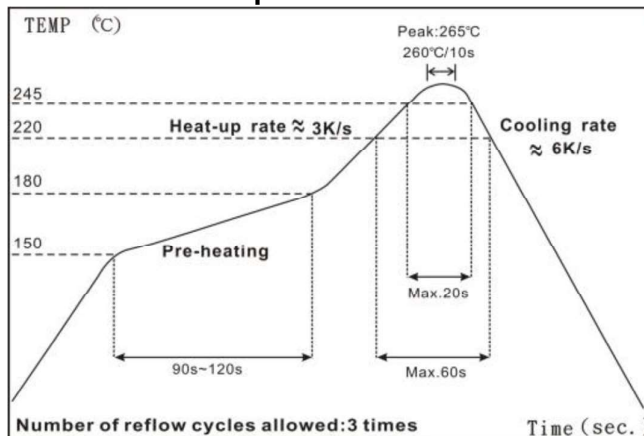



TGL Series Metal Film Anti-Surge Low-Resistance Chip Resistor Product Specifications

Document No.	S-10-12-35-07
Released Date	2020/3/26
Page No.	7/10

■ Rework temperature (hot air equipment) : 350°C, 3~5seconds

■ Recommended reflow methods

IR, vapor phase oven, hot air oven

If reflow temperatures exceed the recommended profile, devices may not meet the performance requirements.

■ Recommend Land Pattern Design

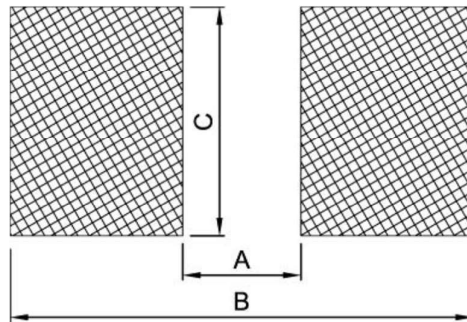

Unit: mm

TYPE	A	B	C
TGL1206	2.20	4.20	1.80
TGL1210	2.00	4.40	2.70
TGL2010	3.80	6.60	2.70
TGL2512	4.90	8.10	3.40

■ Plating Thickness

Ni: $\geq 3\mu\text{m}$

Sn(Tin): $\geq 3\mu\text{m}$



TGL Series Metal Film Anti-Surge Low-Resistance Chip Resistor Product Specifications

Document No.	S-10-12-35-07
Released Date	2020/3/26
Page No.	8/10

■ **Appendix For SMD Chip Resistor**

■ **Packaging Information**

■ **Reel Dimensions**

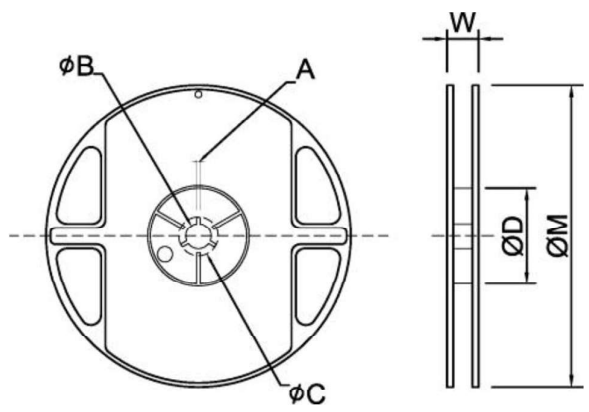

Unit: mm

TYPE	SIZE	A	φB	φC	φD	W	φM
TGL1206	7" 5K/Reel	2.0±0.5	13.5±1.0	21±1.0	60±1.0	11.5±2.0	178±2.0
TGL1210	7" 5K/Reel	2.0±0.5	13.5±1.0	21±1.0	60±1.0	11.5±2.0	178±2.0
TGL2010	7" 4K/Reel	2.0±0.5	13.5±1.0	21±1.0	60±1.0	11.5±2.0	178±2.0
TGL2512	7" 4K/Reel	2.0±0.5	13.5±1.0	21±1.0	60±1.0	16.0±2.0	178±2.0



TGL Series Metal Film Anti-Surge Low-Resistance Chip Resistor Product Specifications

Document No.	S-10-12-35-07
Released Date	2020/3/26
Page No.	9/10

■ **Packaging Information**

■ **Tapping Specifications**

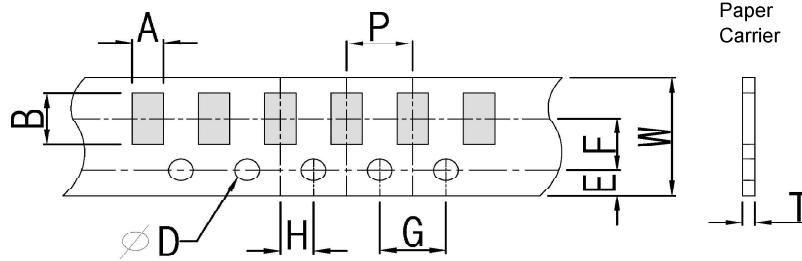

Unit: mm

Packaging	Type	A	B	W	E	F	G	H	T	ΦD	P
Paper Type	1206	1.90±0.2	3.05±0.2	8.0±0.2	1.75±0.1	3.5±0.05	4.0±0.1	2.0±0.05	0.75±0.1	1.50 ^{+0.1} ₋₀	4.0±0.1
	1210	2.85±0.2	3.05±0.2	8.0±0.2	1.75±0.1	3.5±0.05	4.0±0.1	2.0±0.05	0.75±0.1		4.0±0.1

■ **Embossed Dimensions**

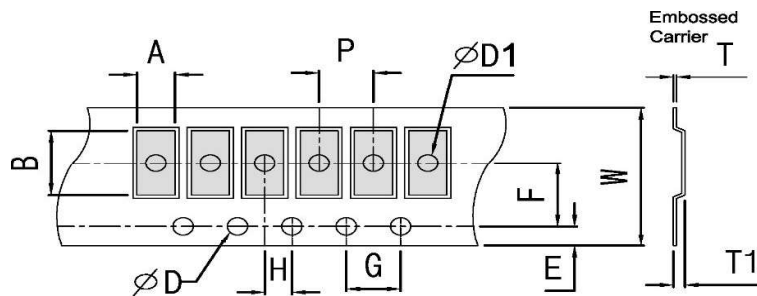

Unit: mm

Packaging	Type	A	B	W	E	F	G	H	T	ΦD	ΦD1	T1	P
Embossed Type	2010	2.80±0.2	5.60±0.2	12±0.1	1.75±0.1	5.5±0.05	4.0±0.1	2.0±0.05	0.23±0.1	1.50 ^{+0.1} ₋₀	1.50±0.1	0.85±0.15	4.0±0.1
	2512	3.40±0.2	6.70±0.2	12±0.1	1.75±0.1	5.5±0.05	4.0±0.1	2.0±0.05	0.23±0.1		1.50±0.1	0.85±0.15	4.0±0.1



TGL Series Metal Film Anti-Surge Low-Resistance Chip Resistor Product Specifications

Document No.	S-10-12-35-07
Released Date	2020/3/26
Page No.	10/10

■ **Packing Material Data / Storage Data**

■ **Front & Back Lead Dimensions**

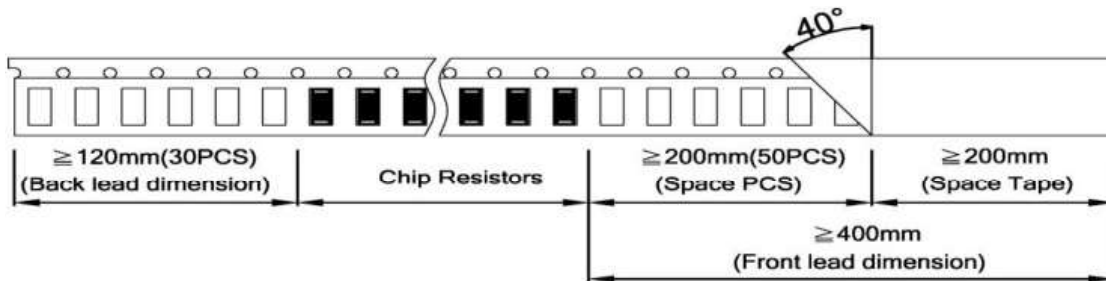

■ **Top Adhesive Peel Off Strength : 10~70g**

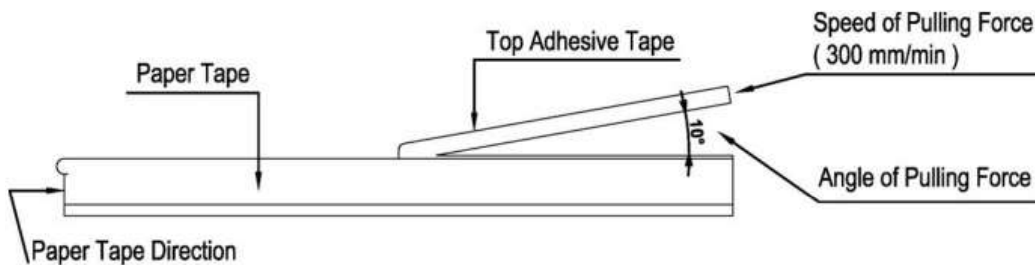

■ **Package**

Inner Box Size	
Reel	Size H(mm)
1	13
2	24
3	36
5	60
10	113

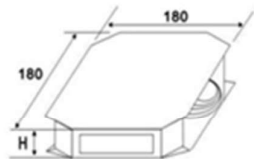

External Box Size			
Contain (Kpcs)	Length (mm)	Width (mm)	Width (mm)
25K	180	180	60
50K	180	180	110
150K	430	200	200
300K	400	400	200

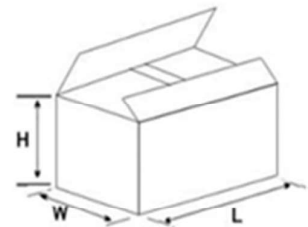

■ **Storage Data :**

Storage time at the environment temp: $25\pm 5^{\circ}\text{C}$ & humidity: $60\pm 20\%$ is valid for one year from the date of delivery.

单击下面可查看定价，库存，交付和生命周期等信息

[>>天二](#)