

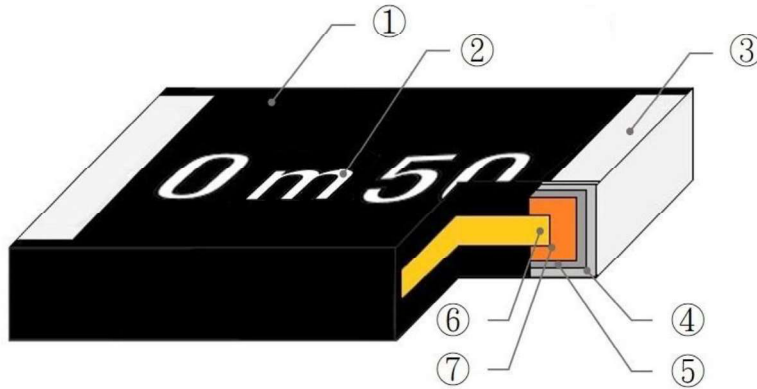

# MU Series Metal Plate Ultra Low-Resistance Resistor Product Specifications

Document No.	S-10-12-84-01
Revised Date	2021/07/21
Page No.	1/8

## ■ Metal Plate Ultra Low Resistance Chip Resistor — MU Series



1	Protective Layer	3	Terminal	5	Ni Plating	7	Cu Plating
2	Marking	4	Sn Plating	6	Metal Plate		

### ■ Application

- Entertainment equipment
- Power Supply
- Measuring instrument
- Industrial equipment
- Battery management system

### ■ Features

- Low Resistance(down to 0.3mR) / Low TCR(down to 50ppm)
- Ultra Low TCR(down to 30ppm)
- Low Inductance( $\leq 5nH$ )
- Excellent long term stability
- RoHs compliant and halogen & Lead free.
- High precision current sensing and voltage division.
- AEC-Q200 Compliant

### ■ Parts Number Explanation

#### ■ Example:

MU	2512	20	F	R001	M	Z
Product Type	Size (Inch) 2512	Rated Power 20= 2.00 W 30= 3.00 W	Tolerance D : $\pm 0.5\%$ F : $\pm 1\%$ G : $\pm 2\%$ J : $\pm 5\%$	Resistance 0m30= 0.3 mR R002= 2.0 mR	Material M : MnCu	Optional Z : Default code U : Ultra Low TCR



## MU Series Metal Plate Ultra Low-Resistance Resistor Product Specifications

Document No.	S-10-12-84-01
Revised Date	2021/07/21
Page No.	2/8

### ■ Standard Electrical Specifications

Type	Rating Power at 70°C	T.C.R. (ppm/°C)	Max. Rating Current	Max. Overload Current	Resistance Range (mΩ)		Material	Operating Temperature Range (°C)
					0.5%(D)	1.0% (F) 2.0% (G) 5.0% (J)		
MU2512	2W	≤±150	81.65A	182.57A		0.3	0.3mR~2mR:MnCu	- 55 ~ + 170
		≤±75	63.24A	141.42A		0.5		
		≤±50	44.72A	100A	1~2	1~2		
	3W	≤±150	100A	223.6A		0.3		
		≤±75	77.46A	173.20A		0.5		
		≤±50	54.77A	122.47A	1~2	1~2		

### ■ Ultra Low TCR Electrical Specifications

Type	Rating Power at 70°C	T.C.R. (ppm/°C)	Max. Rating Current	Max. Overload Current	Resistance Range (mΩ)		Material	Operating Temperature Range (°C)
					0.5%(D)	1.0% (F) 2.0% (G) 5.0% (J)		
MU2512	2W	≤±100	81.65A	182.57A		0.3	0.3mR~2mR:MnCu	- 55 ~ + 170
		≤±50	63.24A	141.42A		0.5		
		≤±30	44.72A	100A	1~2	1~2		
	3W	≤±100	100A	223.6A		0.3		
		≤±50	77.46A	173.20A		0.5		
		≤±30	54.77A	122.47A	1~2	1~2		



# MU Series Metal Plate Ultra Low-Resistance Resistor Product Specifications

Document No.	S-10-12-84-01
Revised Date	2021/07/21
Page No.	3/8

## ■ Type Dimension

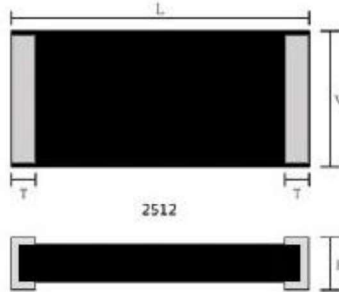

## ■ Dimension

Unit : mm

Series Size	Power Rating	Resistance Range	L	W	H	T
MU2512	2W	0.3mΩ	6.35±0.254	3.10±0.254	1.25±0.254	2.55±0.254
		0.5mΩ			1.25±0.254	1.70±0.254
		1mΩ			0.65±0.254	1.40±0.254
		2mΩ			0.35±0.254	1.40±0.254
	3W	0.3mΩ			1.25±0.254	2.55±0.254
		0.5mΩ			1.25±0.254	1.70±0.254
		1mΩ			0.65±0.254	1.40±0.254
		2mΩ			0.35±0.254	1.40±0.254

## ■ Performance Characteristics

### Power Derating Curve

The Operating Temperature Range: -55°C ~+170°C.

For resistors operated in ambient temperatures above 70°C, power rating must be derating in accordance with the curve as below :

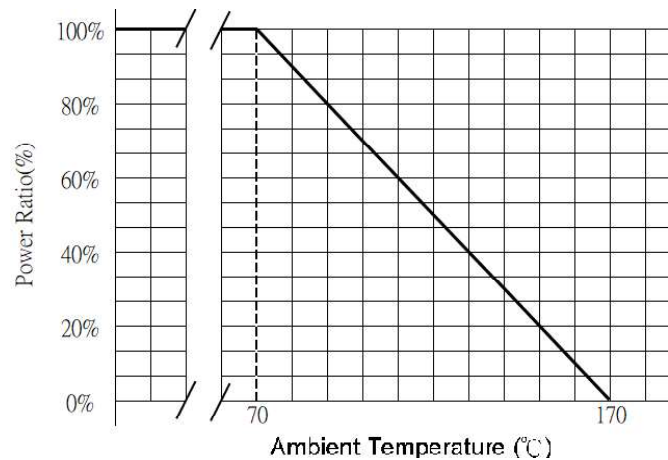



## MU Series Metal Plate Ultra Low-Resistance Resistor Product Specifications

Document No.	S-10-12-84-01
Revised Date	2021/07/21
Page No.	4/8

### ■ Rating Current

The following equation may be used to determine the DC (Direct Current) or AC (Alternating Current) (RMS, root mean square value) of normal rated power. However, if the result value exceeds the highest current of regulated standards, the highest normal rated power is to be used

$$I = \sqrt{P/R}$$

I = Rating current (A)  
P= Rating Power (W)  
R= Resistance( $\Omega$ )

- Inductance characteristics:  $\leq 5\text{nH}$ (Circuit frequency is below 1MHz)

### ■ Marking Format:

- 2512 2W and 3W 0.3mR no marking.
- The Others marking are 4 digits.
- "R" designates the decimal location in ohms  
e.g. 2m $\Omega$  the product marking is R002.
- "m" designates the decimal location in milli-ohms  
e.g. 0.5m $\Omega$  the product marking is 0m50.
- The criteria to distinguishing the mark on the surface of products are that characters can be identified.



## MU Series Metal Plate Ultra Low-Resistance Resistor Product Specifications

<b>Document No.</b>	S-10-12-84-01
<b>Revised Date</b>	2021/07/21
<b>Page No.</b>	5/8

### ■ Reliability Test and Requirement

Test Item	Test Method	Procedure	Requirements
Temperature Coefficient of Resistance (T.C.R)	JIS-C-5201-1 4.8 IEC-60115-1 4.8	At 25°C /+125°C, 25°C is the reference temperature	Refer to Ratings
Short Time Overload	JIS-C-5201-1 4.13 IEC-60115-1 4.13	The number of rated power are as follows: <ul style="list-style-type: none"> <li>● MU2512-2W: 5 times of rated power</li> <li>● MU2512-3W: 5 times of rated power for 5 seconds.</li> </ul>	$\Delta R/R1 \leq \pm 1.0\%$
High Temperature Exposure	JIS-C5201-1 4.25 IEC 60068-2-2	At 170°C for 1000 hours.	$\Delta R/R1 \leq \pm 1.0\%$
Resistance to Soldering Heat	JIS-C-5201-1 4.18 IEC-60115-1 4.18	260±5°C for 10 seconds.	$\Delta R/R1 \leq \pm 0.5\%$
Temperature Cycling	JESD22 Method JA-104	1000 Cycles (-55°C to +155°C) Measurement at 24±4 hours after test conclusion. 30min maximum dwell time at each temperature extreme.	$\Delta R/R1 \leq \pm 1.0\%$
Biased Humidity	MIL-STD-202 Method 103	1,000 hours; 85°C / 85% RH, 10% of operating power. Measurement at 24±4 hours after test conclusion.	$\Delta R/R1 \leq \pm 1.0\%$
Load Life (Endurance)	JIS-C-5201-1 4.25 IEC-60115-1 4.25.1	70±2°C, RCWV or Max. working voltage whichever is less for 1000 hrs with 1.5 hrs "ON" and 0.5 hr "OFF" .	$\Delta R/R1 \leq \pm 1.0\%$
Solderability	JIS-C-5201-1 4.17 IEC-60115-1 4.17	245±5°C for 3 seconds.	>95% coverage
Dielectric Withstanding Voltage	JIS-C5201-1 4.7	Applied 500VAC for 1 minute.	No short or burned on the appearance.
Core Body Strength	JIS-C5201-1 4.15	Central part pressurizing force : 5N , 10 seconds	No broken
Terminal Strength (SMD)	AEC Q200-006	Pressurizing force : 17.7N , 60 seconds	No broken
Bending Strength	JIS-C-5201-1 4.33 IEC-60115-1 4.33	Bending once for 2mm , 10 seconds	$\Delta R/R1 \leq \pm 0.5\%$ No broken
Moisture Resistance	MIL-STD 202 Method 106	T=24 hours / Cycle ,10Cycles . Steps 7a& 7b not required. Unpowered . (Figure 1)	$\Delta R/R1 \leq \pm 0.5\%$



# MU Series Metal Plate Ultra Low-Resistance Resistor Product Specifications

Document No.	S-10-12-84-01
Revised Date	2021/07/21
Page No.	6/8

Figure 1

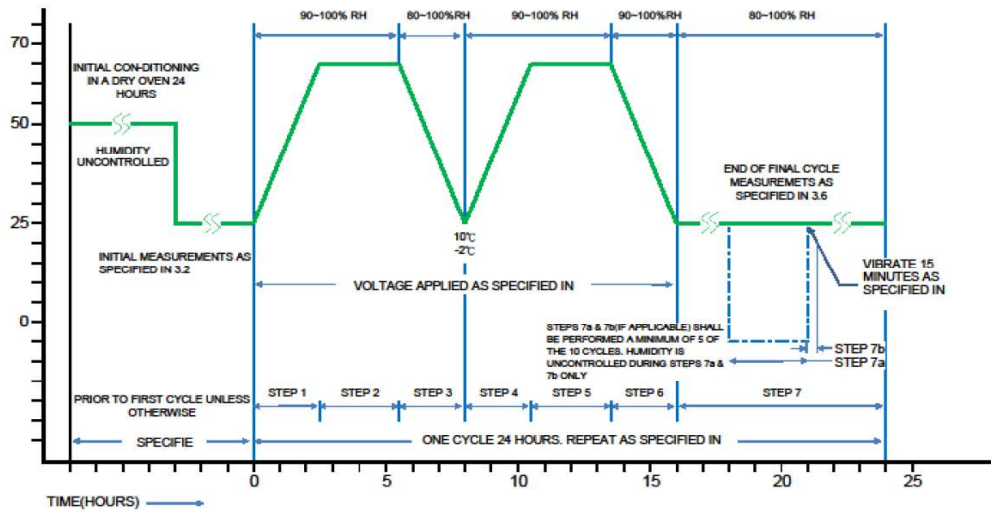

## ■ Soldering Profile

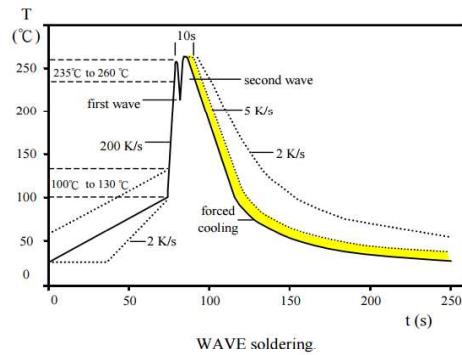
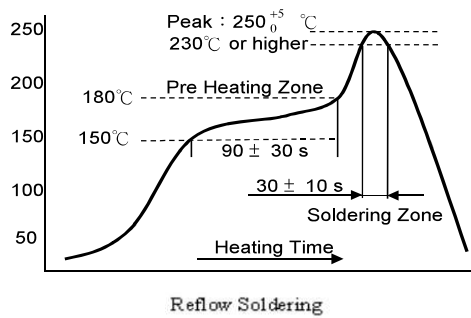



# MU Series Metal Plate Ultra Low-Resistance Resistor Product Specifications

Document No.	S-10-12-84-01
Revised Date	2021/07/21
Page No.	7/8

## Recommend Land Pattern Design

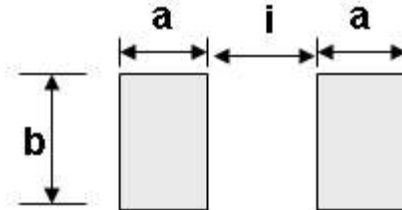

## Dimension

Unit: mm

TYPE	Resistance Range	a	b	i
MU2512 – 2W/3W	0.3mΩ	2.80	3.55	2.00
MU2512 – 2W/3W	0.5mΩ	2.80	3.55	2.00
MU2512 – 2W/3W	1mΩ	2.70	3.55	2.90
MU2512 – 2W/3W	2mΩ	2.40	3.55	2.00

## Packing Quantity

TYPE	PCS /Reel
MU2512-2W/3W,1m~2mR	4,000
MU2512-2W/3W,0.3m~0.5mR	2,000



**MU Series Metal Plate Ultra  
Low-Resistance Resistor Product  
Specifications**

<b>Document No.</b>	S-10-12-84-01
<b>Revised Date</b>	2021/07/21
<b>Page No.</b>	8/8

**Appendix For SMD Chip Resistor**

**● Packaging Information**

**■ Reel Dimensions**

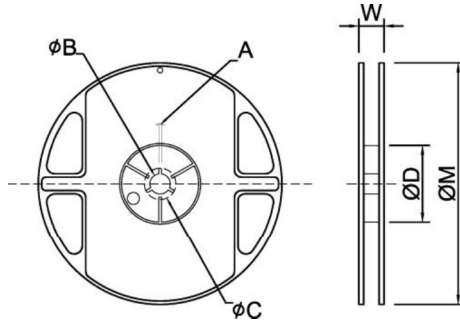

**Dimension**

**Unit: mm**

Reel Type / Tape	A	φB	φC	φD	W	φM
7" reel for 12 mm embossed	2.5±0.5	13.5±0.5	17.7±0.5	60.0±0.5	16.2±0.5	178±1.0

**■ Embossed Dimensions**

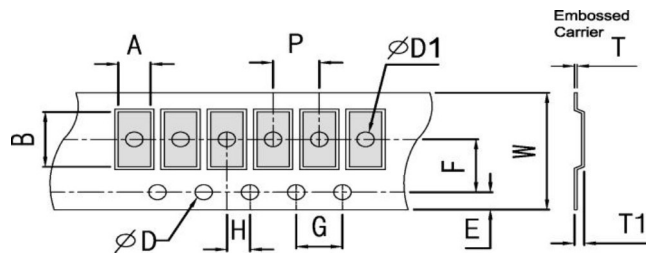

**Dimension**

**Unit: mm**

Item	W	P	E	F	φD	φD1	G	H	A	B	T1	T
MU2512 2W/3W 1m~2mR	12.0±0.30	4.0±0.10	1.75±0.10	5.5±0.10	1.50 <sup>+0.1</sup>	1.55±0.10	4.0±0.10	2.0±0.10	3.50±0.10	6.75±0.10	0.90±0.20	0.20±0.10
MU2512 2W/3W 0.3m~0.5mR	12.0±0.30	4.0±0.10	1.75±0.10	5.5±0.10		1.55±0.10	4.0±0.10	2.0±0.10	3.50±0.10	6.75±0.10	1.45±0.20	0.20±0.10

**■ Storage Temperature**

Temperature : 25±5°C, Humidity : 60±20%



单击下面可查看定价，库存，交付和生命周期等信息

[>>EVER OHMS\(天二\)](#)