

■ Metal Alloy Low Resistance Chip Resistor — MR Series

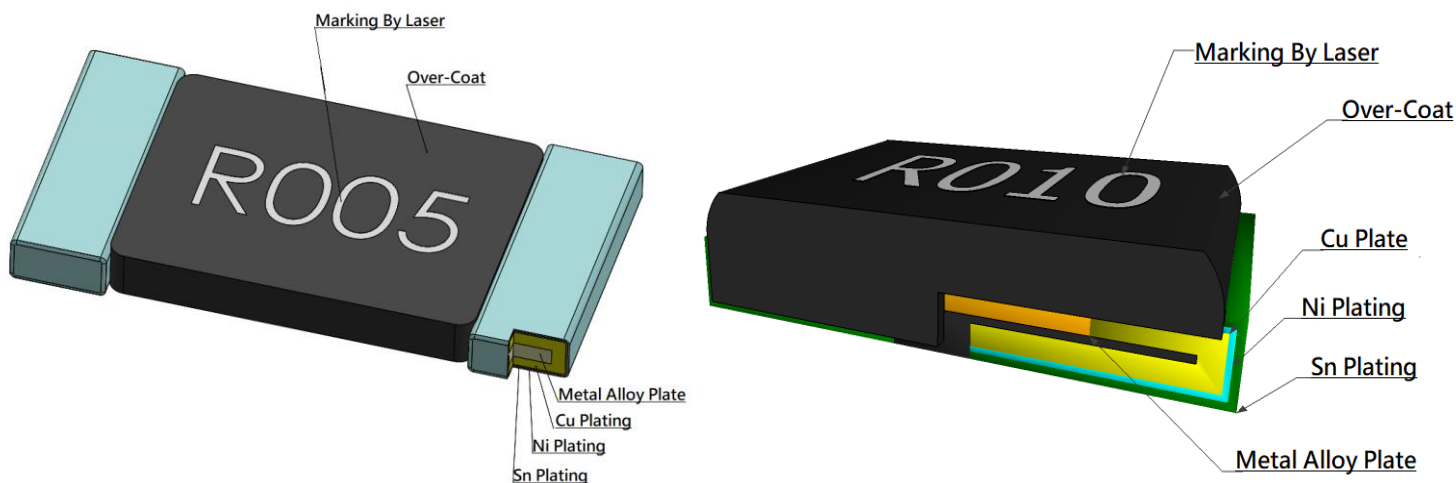

■ Application

- Entertainment equipment
- Power Supply
- Measuring instrument
- Industrial equipment
- Battery management system

■ Features

- Low Resistance / Low TCR/ Low Inductance(Only *Z)
- Excellent long term stability
- RoHs compliant and halogen free.
- Lead free.
- High precision current sensing and voltage division.

■ Parts Number Explanation

■ Example:

MR	2512	20	F	R004	M	Z
Product Type	Size (Inch)	Rated Power	Tolerance	Resistance	Material	Optional
	2512 2818	20=2.00W 30=3.00W 50=5.00W	F : ±1% G : ±2% J : ±5%	R005=5.0mR R010=10mR	M : MnCu F : FeCrAl R : NiCrAl	Z:Normal Type(Low inductance) G:Anti-Surge Type



MR Series Metal Alloy Low-Resistance Resistor Product Specifications

Document No.	S-10-12-09-08
Released Date	2019/11/28
Page No.	2/8

Standard Electrical Specifications

Type	Rating Power at 70°C	T.C.R. (ppm/°C)	Max. Rating Current	Max. Overload Current	Resistance Range (mΩ)	Material	Operating Temperature Range (°C)
					1.0% (F) 2.0% (G) 5.0% (J)		
MR2512*Z	2W	≤ ±50	31.62A	70.71A	2~3	R002~R010 : MnCu	- 55 ~ + 170
		≤ ±50	22.36A	50A	4~10		
	3W	≤ ±50	38.73A	86.60A	2~3	R002~R010 : MnCu	
		≤ ±50	27.38A	61.23A	4~10		
MR2512*G	2W	≤ ±100	44.72A	100.00A	1	R001~R004 : MnCu R005~R050 : FeCrAl	
		≤ ±50	31.62A	70.71A	2~50		
	3W	≤ ±100	54.77A	122.47A	1	R001~R003 : MnCu R004~R050 : FeCrAl	
		≤ ±50	38.73A	86.60A	2~50		
MR2818*Z	5W	≤ ±200	35.35A	70.71A	4~7	R004~R007 : MnCu	
MR2818*G		≤ ±75	25A	50A	8~50	R008~R050 : NiCrAl	
		≤ ±75	25A	50A	8~50	R008~R050 : FeCrAl	

Note: MR 2818 8mR~50mR 優先採用 FeCrAl (*G), 若應用於 2818 的 waveform 有頻率的要求, 則才改用 NiCrAl (*Z)

Note: Inductance characteristics MR 2512*Z, MR 2818*Z : <5nH

Note: MR 2818 8mR~50mR preferred FeCrAl (*G), and NiCrAl (*Z) was used only if the waveform of 2818 had a frequency requirement.

Note: Inductance characteristics MR 2512*Z, MR 2818*Z : <5nH

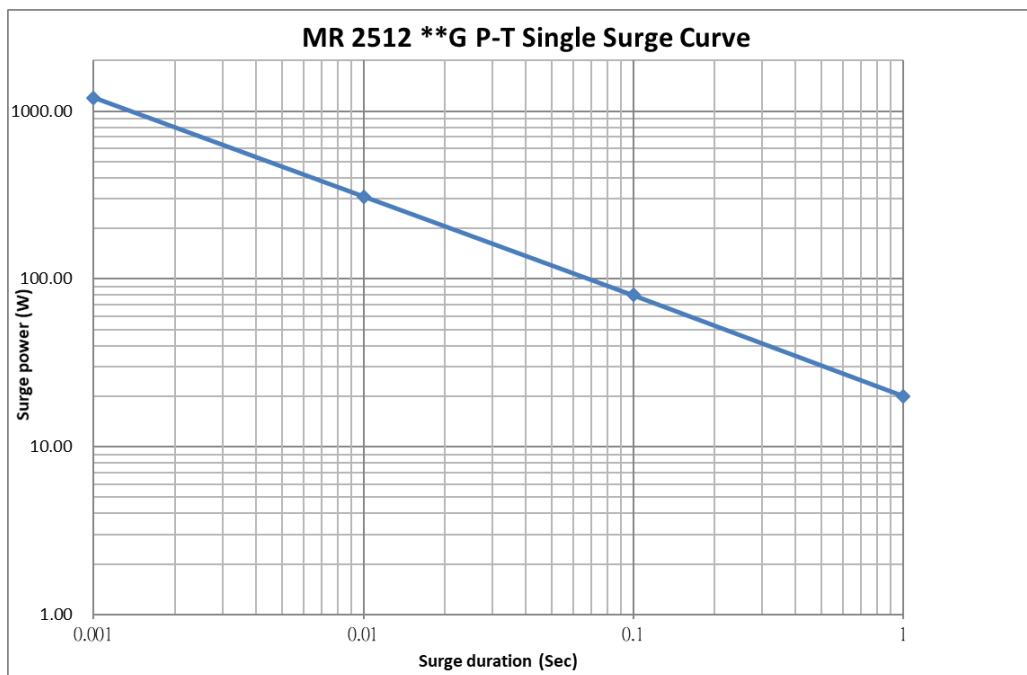



MR Series Metal Alloy Low-Resistance Resistor Product Specifications

Document No. S-10-12-09-08
 Released Date 2019/11/28
 Page No. 3/8

■ Type Dimension

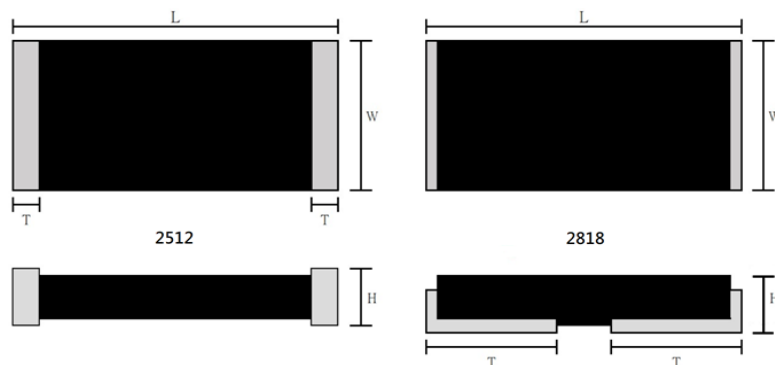

■ Dimension

Unit : mm

	Power Rating	Resistance Range	L	W	H	T		
MR2512*Z	2W	2~10mΩ(MnCu)	6.35±0.254	3.10±0.254	0.70±0.254	0.95±0.254		
	3W	2~10mΩ(MnCu)			0.70±0.254	0.95±0.254		
MR2512*G	2W	1mΩ(MnCu)			0.90±0.254	1.9±0.254		
	2W	2mΩ~4mΩ(MnCu)			0.90±0.254	0.80±0.254		
	2W	5mΩ~50mΩ(FeCrAl)			0.90±0.254	0.80±0.254		
	3W	1mΩ~3mΩ(MnCu)			1.10±0.254	0.80±0.254		
	3W	4mΩ(FeCrAl)			1.10±0.254	0.80±0.254		
	3W	5mΩ~50mΩ(FeCrAl)			0.90±0.254	0.80±0.254		
MR2818*Z MR2818*G	5W	4~50mΩ			7.15±0.254	4.95±0.254	1.65±0.254	2.90±0.254



MR Series Metal Alloy Low-Resistance Resistor Product Specifications

Document No. S-10-12-09-08

Released Date 2019/11/28

Page No. 4/8

■ Performance Characteristics

Power Derating Curve

The Operating Temperature Range: -55°C ~+170°C.

For resistors operated in ambient temperatures above 70°C, power rating must be derating in accordance with the curve as below :

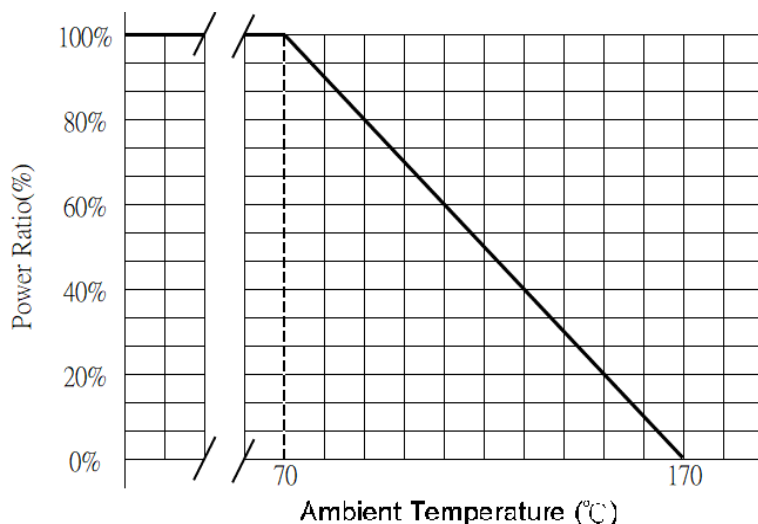

■ Rating Current

The following equation may be used to determine the DC (Direct Current) or AC (Alternating Current) (RMS, root mean square value) of normal rated power. However, if the result value exceeds the highest current of regulated standards, the highest normal rated power is to be used

$$I = \sqrt{P/R}$$

I = Rating current (A)

P= Rating Power (W)

R= Resistance(Ω)

■ Marking Format:

- All the products marking are 4 digits.
- “R” designates the decimal location in ohms
e.g. 3mΩ the product marking is R003.
10mΩ the product marking is R010.
- The criteria to distinguishing the mark on the surface of products are that characters can be identified.



MR Series Metal Alloy Low-Resistance Resistor Product Specifications

Document No.	S-10-12-09-08
Released Date	2019/11/28
Page No.	5/8

Reliability Test and Requirement

Test Item	Test Method	Procedure	Requirements
Temperature Coefficient of Resistance (T.C.R)	JIS-C-5201-1 4.8 IEC-60115-1 4.8	At 25°C /+125°C, 25°C is the reference temperature	Refer to Ratings
Short Time Overload	JIS-C-5201-1 4.13 IEC-60115-1 4.13	The number of rated power are as follows: <ul style="list-style-type: none"> MR2512-2W: 5 times of rated power MR2512-3W: 5 times of rated power MR2818-5W: 4 times of rated power for 5 seconds. 	$\Delta R/R1 \leq \pm 1.0\%$
High Temperature Exposure	JIS-C5201-1 4.25 IEC 60068-2-2	At 170°C for 1000 hours.	$\Delta R/R1 \leq \pm 1.0\%$
Resistance to Soldering Heat	JIS-C-5201-1 4.18 IEC-60115-1 4.18	260±5°C for 10 seconds.	$\Delta R/R1 \leq \pm 0.5\%$
Temperature Cycling	JESD22 Method JA-104	1000 Cycles (-55°C to +155°C) Measurement at 24±4 hours after test conclusion. 30min maximum dwell time at each temperature extreme.	$\Delta R/R1 \leq \pm 1.0\%$
Biased Humidity	MIL-STD-202 Method 103	1,000 hours; 85°C / 85% RH, 10% of operating power. Measurement at 24±4 hours after test conclusion.	$\Delta R/R1 \leq \pm 1.0\%$
Load Life (Endurance)	JIS-C-5201-1 4.25 IEC-60115-1 4.25.1	70±2°C, RCWV or Max. working voltage whichever is less for 1000 hrs with 1.5 hrs "ON" and 0.5 hr "OFF" .	$\Delta R/R1 \leq \pm 1.0\%$
Solderability	JIS-C-5201-1 4.17 IEC-60115-1 4.17	245±5°C for 3 seconds.	>95% coverage
Dielectric Withstanding Voltage	JIS-C5201-1 4.7	Applied 500VAC for 1 minute.	No short or burned on the appearance.
Core Body Strength	JIS-C5201-1 4.15	Central part pressurizing force : 5N , 10 seconds	No broken
Terminal Strength (SMD)	AEC Q200-006	Pressurizing force : 17.7N , 60 seconds	No broken
Bending Strength	JIS-C-5201-1 4.33 IEC-60115-1 4.33	Bending once for 2mm , 10 seconds	$\Delta R/R1 \leq \pm 0.5\%$ No broken
Moisture Resistance	MIL-STD 202 Method 106	T=24 hours / Cycle ,10Cycles . Steps 7a& 7b not required. Unpowered . (Figure 1)	$\Delta R/R1 \leq \pm 0.5\%$



MR Series Metal Alloy Low-Resistance Resistor Product Specifications

Document No.	S-10-12-09-08
Released Date	2019/11/28
Page No.	6/8

Figure 1

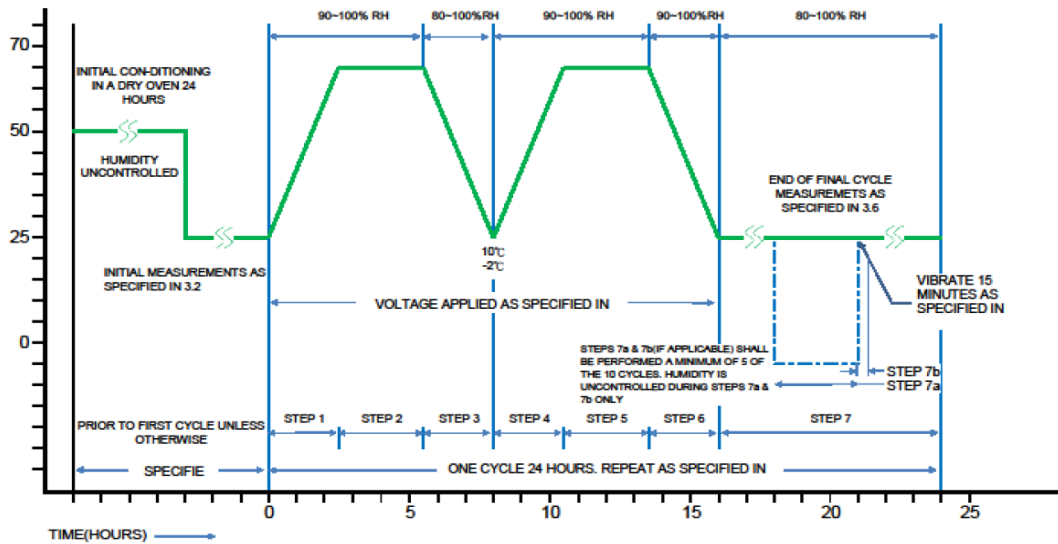

■ Soldering Profile

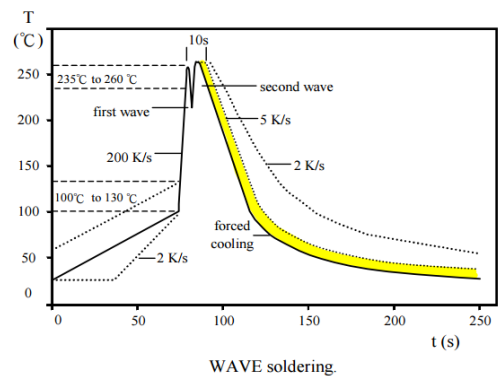
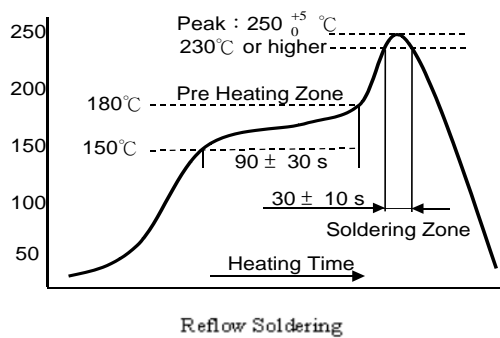



MR Series Metal Alloy Low-Resistance Resistor Product Specifications

Document No. S-10-12-09-08

Released Date 2019/11/28

Page No. 7/8

Recommend Land Pattern Design

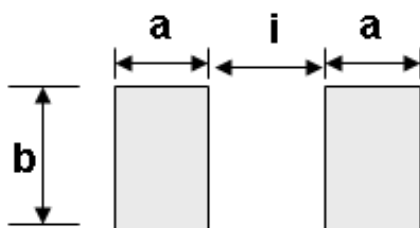

Dimension

Unit: mm

TYPE	Resistance Range	a	b	i
MR2512*Z – 2W/3W	2mΩ~10mΩ	2.50	4.50	3.80
MR2512*G – 2W	1mΩ	3.00	4.50	1.45
MR2512*G – 2W	2mΩ~50mΩ	2.50	4.50	3.80
MR2512*G – 3W	1mΩ~50mΩ	2.50	4.50	3.80
MR2818*G,*Z – 5W	4mΩ~50mΩ	3.50	5.30	0.60

Packing Quantity

TYPE	PCS /Reel
MR2512*Z-2W/3W	4,000
MR2512*G-2W,1m~50mR	4,000
MR2512*G-3W,1m~4mR	3,000
MR2512*G-3W,5m~50mR	4,000
MR2818-5W	3,500

■ Appendix For SMD Chip Resistor

● Packaging Information

■ Reel Dimensions

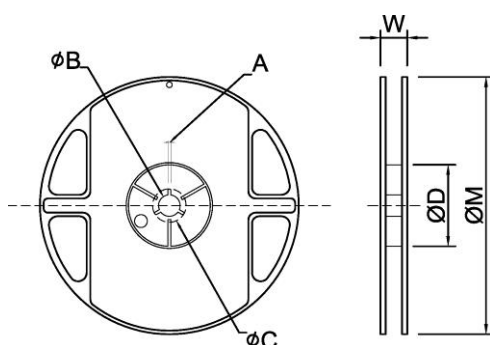

■ Dimension

Unit: mm

Reel Type / Tape	A	φB	φC	φD	W	φM
7" reel for 12 mm embossed	2.5±0.5	13.5±0.5	17.7±0.5	60.0±0.5	16.2±0.5	178±1.0
13" reel for 16 mm embossed	2.3±0.5	13.5±0.5	17.7±0.5	99.0±0.5	20.7±0.5	330±1.0

■ Embossed Dimensions

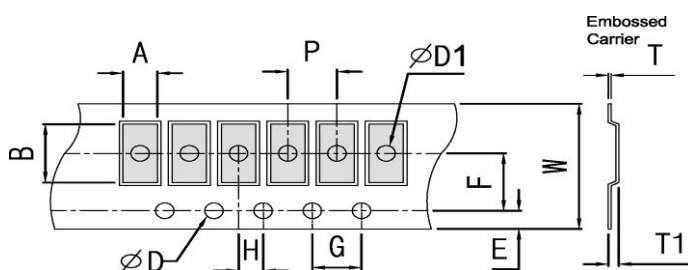

■ Dimension

Unit: mm

Item	W	P	E	F	φD	φD1	G	H	A	B	T1	T
MR2512	12.0±0.30	4.0±0.10	1.75±0.10	5.5±0.10	1.50 ^{+0.1} ₀	1.55±0.10	4.0±0.10	2.0±0.10	3.50±0.10	6.75±0.10	0.90±0.20	0.20±0.10
MR2512*G 3W,1m-4mR	12.0±0.30	4.0±0.10	1.75±0.10	5.5±0.10		1.55±0.10	4.0±0.10	2.0±0.10	3.50±0.10	6.75±0.10	1.30±0.20	0.20±0.10
MR2818	16.0±0.30	8.0±0.10	1.75±0.10	7.5±0.10		1.50 ^{+0.1} ₀	4.0±0.10	2.0±0.10	5.21±0.10	7.69±0.10	1.97±0.10	0.30±0.05

■ Storage Temperature

Temperature : 25±5°C, Humidity : 60±20%

单击下面可查看定价，库存，交付和生命周期等信息

[>>天二](#)