

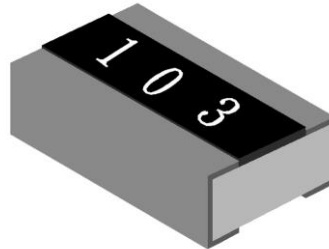

CRW Series Thick Film Wide Terminal Chip Resistor Product Specifications

Document No.	S-10-12-19-15
Released Date	2023/06/17
Page No.	1/13

Thick Film Wide Terminal Chip Resistor— CRW Series



Application

- Navigation equipment
- Power equipment: Power supply, Illumination equipment
- Indoor lighting, Central door locking

Features

- Small size and light weight
- Reliability, high quality
- Chip resistor of the wide terminal type

Parts Number Explanation

Example:

CRW	0612	J	10R0	P	05	Z
Product Type	Size (Inch)	Resistor Tolerance	Resistor Value	Package	Quantity	Optional
CRW	0508 0612 1020 1218 1225	F : $\pm 1\%$ J : $\pm 5\%$	10mR=R010 100mR=R100 1R=1R00 10R=10R0 100R=100R 1K=1K00 1M=1M00	P : Paper Taping (0508、0612) E : Embossed Taping (1020-1225)	04 : 4000PCS 05 : 5000PCS	Z : Default H: High Power



CRW Series Thick Film Wide Terminal Chip Resistor Product Specifications

Document No.	S-10-12-19-15
Released Date	2023/06/17
Page No.	2/13

Standard Electrical Specifications

Item Type	Rated Power at 70°C	Max Working Voltage	Max Overload Voltage	T.C.R. (PPM/°C)	Resistance Range	
					F(±1%)	J(±5%)
CRW0508	0.75W	200V	400V	±200	1Ω ≤ R < 10Ω	
				±100	10Ω ≤ R ≤ 1MΩ	
CRW0612	0.75W			±200	1Ω ≤ R < 10Ω	
				±100	10Ω ≤ R ≤ 10MΩ	
CRW1020	1W			±200	1Ω ≤ R < 10Ω	
				±100	10Ω ≤ R ≤ 10MΩ	
CRW1218	1W			±200	1Ω ≤ R < 10Ω	
				±100	10Ω ≤ R ≤ 10MΩ	
CRW1225	2W			±200	1Ω ≤ R < 10Ω	
				±100	10Ω ≤ R ≤ 10MΩ	

- For non-standard parts, please contact our sales dept.
- Operating Temperature Range : -55°C ~ +155°C

High Power Electrical Specifications

Item Type	Rated Power at 70°C	Max Working Voltage	Max Overload Voltage	T.C.R. (PPM/°C)	Resistance Range	
					F(±1%)	J(±5%)
CRW0508	1W	200V	400V	±150	1Ω ≤ R < 10Ω	
				±100	10Ω ≤ R ≤ 1MΩ	
CRW0612	1.5 W			±100	1Ω ≤ R < 10Ω	
				±100	10Ω ≤ R ≤ 10MΩ	
CRW1020	2 W			±100	1Ω ≤ R < 10Ω	
				±100	10Ω ≤ R ≤ 10MΩ	
CRW1218	2 W			±100	1Ω ≤ R < 10Ω	
				±100	10Ω ≤ R ≤ 10MΩ	
CRW1225	3W			±100	1Ω ≤ R < 10Ω	
				±100	10Ω ≤ R ≤ 10MΩ	

- For non-standard parts, please contact our sales dept.
- Operating Temperature Range : -55°C ~ +155°C



CRW Series Thick Film Wide Terminal Chip Resistor Product Specifications

Document No.	S-10-12-19-15
Released Date	2023/06/17
Page No.	3/13

Low Ohm Chip Resistor Electrical Specifications

Type	Item	Rated Power at 70°C	Rated Voltage Range	Max Overload Voltage	T.C.R. (PPM/°C)	Resistance Range (mΩ)
						F(±1%)、J±(5%)
CRW0612		0.75W	0.087~0.86V	2.154V	±1800	10 ≤ R < 50
					±800	50 ≤ R < 100
					±600	100 ≤ R < 1000
CRW1020		1W	0.10~0.99V	2.475V	±1800	10 ≤ R < 50
					±800	50 ≤ R < 100
					±600	100 ≤ R < 1000
CRW1218		1W	0.10~0.99V	2.475V	±1800	10 ≤ R < 50
					±800	50 ≤ R < 100
					±600	100 ≤ R < 1000
CRW1225		2W	0.14~1.41V	3.518 V	±1800	10 ≤ R < 50
					±800	50 ≤ R < 100
					±600	100 ≤ R < 1000

- For non-standard parts, please contact our sales dept.
- Operating Temperature Range : -55°C ~ +155°C

Jumper Electrical Specifications

Type	0612	1020	1218	1225
Jumper Resistance Value	20mΩ Max			
Jumper Rated Current	4A	6A	6A	8A
Max. Over Load Current <1 second and 1 times	15A	22A	22A	30A

■ **Type Dimension**

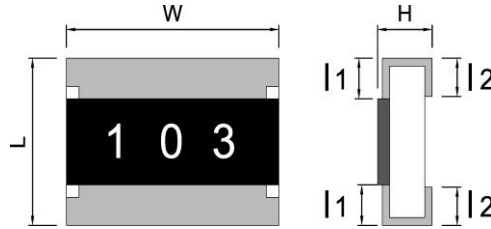

CRW0612/ CRW1020/ CRW1218/
CRW2030/ CRW1225

■ **Dimension**

Unit: mm

Type	L	W	H	l ₁	l ₂
CRW0508	1.25 ± 0.10	2.00 ± 0.10	0.55 ± 0.10	0.25 ± 0.20	0.50 ± 0.20
CRW0612	1.60 ± 0.20	3.20 ± 0.20	0.55 ± 0.10	0.30 ± 0.20	0.50 ± 0.20
CRW1020	2.50 ± 0.20	5.00 ± 0.20	0.55 ± 0.10	0.40 ± 0.20	0.75 ± 0.20
CRW1218	3.10 ± 0.10	4.60 ± 0.10	0.55 ± 0.05	0.40 ± 0.20	0.50 ± 0.20
CRW1225*Z	3.20 ± 0.20	6.50 ± 0.20	0.55 ± 0.20	0.40 ± 0.20	0.75 ± 0.20
CRW1225*H	3.20 ± 0.20	6.50 ± 0.20	0.65 ± 0.20	0.40 ± 0.20	0.75 ± 0.20

● **General Information**

■ **Recommend Land Pattern Design**

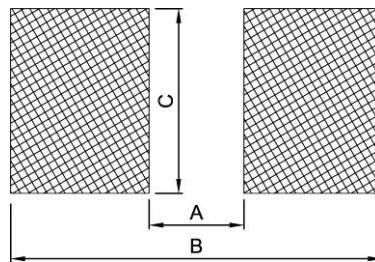

■ **Dimension**

Unit: mm

Type	0508	0612	1020	1218	1225
Item					
A	0.4	0.60	0.75	2.04	0.85
B	1.8	2.90	3.40	4.24	3.70
C	2.00	3.20	5.00	4.80	6.40



CRW Series Thick Film Wide Terminal Chip Resistor Product Specifications

Document No.	S-10-12-19-15
Released Date	2023/06/17
Page No.	5/13

Performance Characteristics

Functional performance

CRW-Z :

Single Pulse

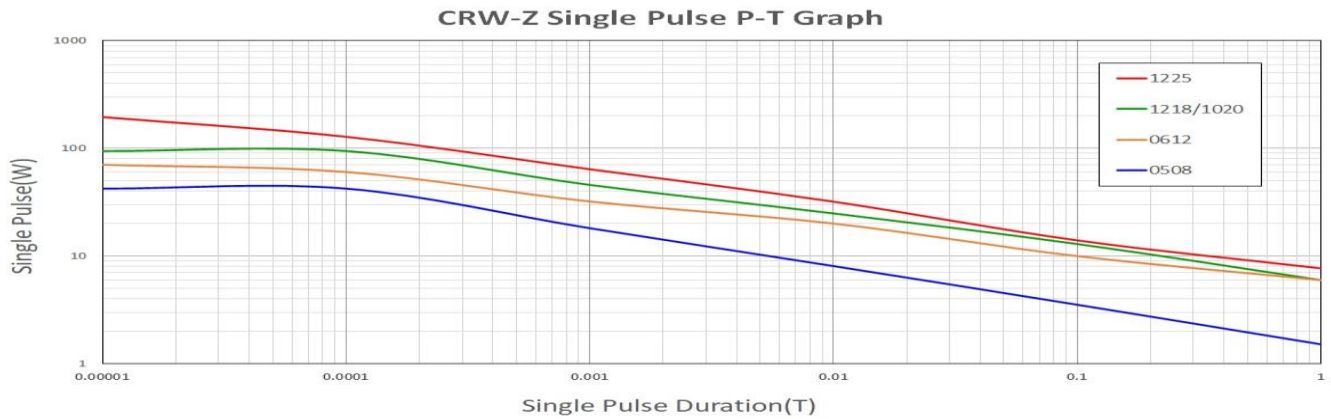

Single pulse; applicable rate power at 70°C and Max working voltage and Max overload voltage.

Continuous Pulse

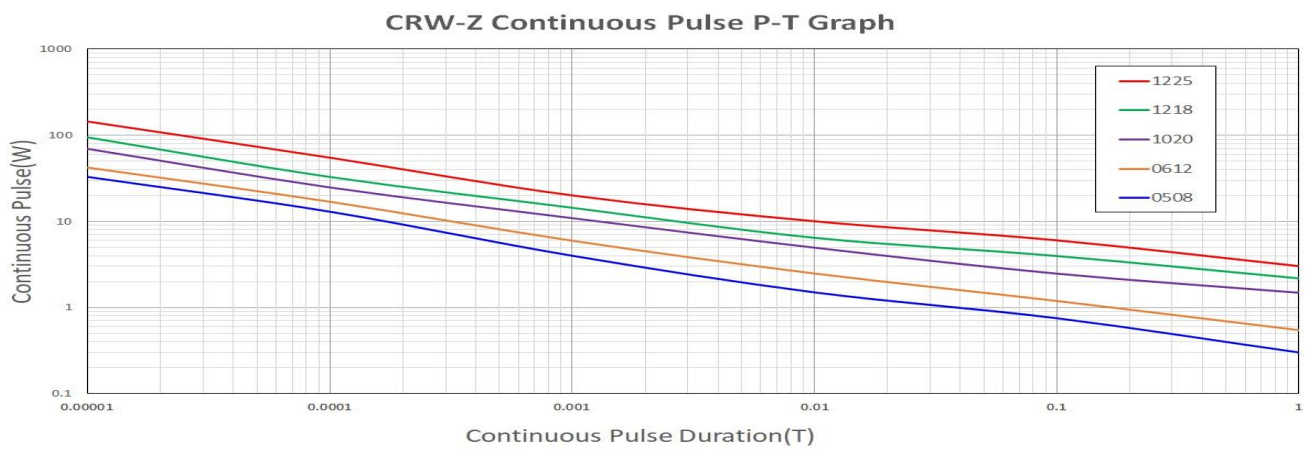

Continuous pulse; applicable rate power at 70°C and Max working voltage and Max overload voltage.

Pulse Voltage

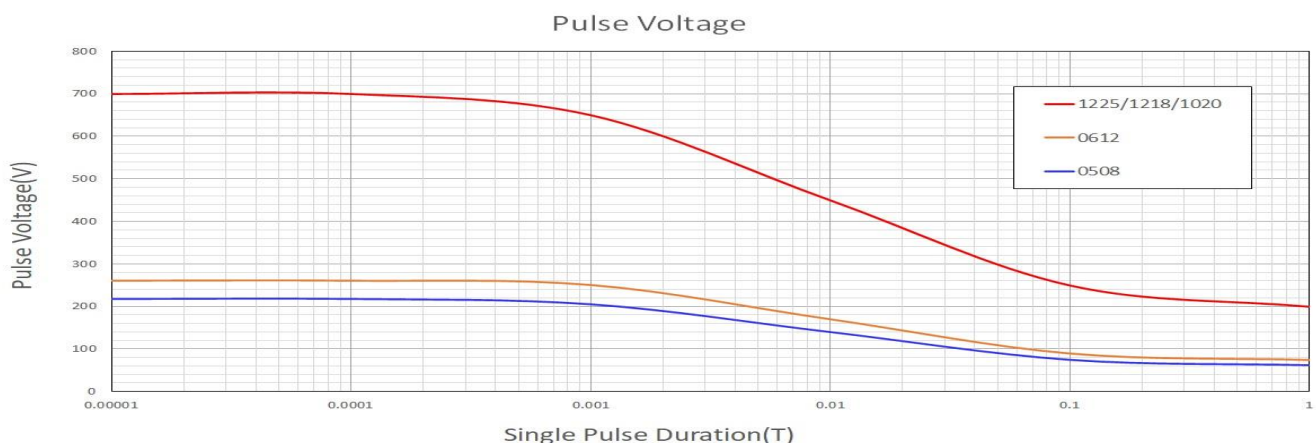

Pulse Voltage; applicable rate power at 70°C and Max working voltage and Max overload voltage.



CRW Series Thick Film Wide Terminal Chip Resistor Product Specifications

Document No.	S-10-12-19-15
Released Date	2023/06/17
Page No.	6/13

CRW-H : Single Pulse

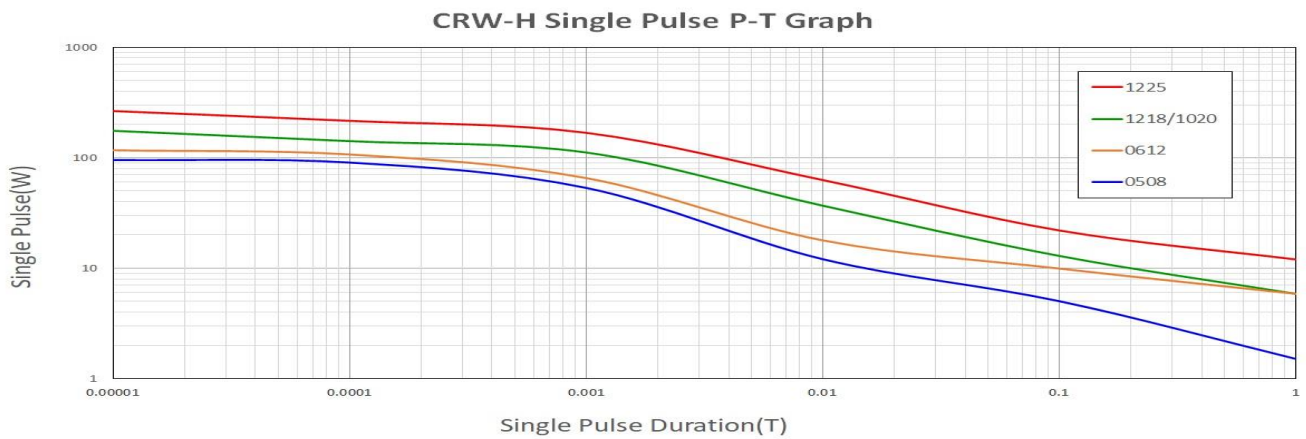

Single pulse; applicable rate power at 70°C and Max working voltage and Max overload voltage.

Continuous Pulse

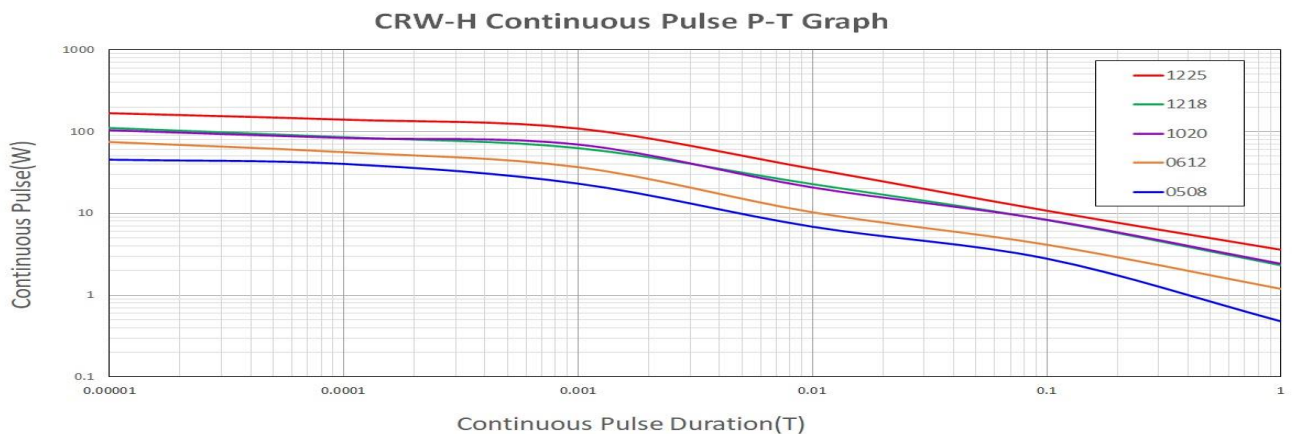

Continuous pulse; applicable rate power at 70°C and Max working voltage and Max overload voltage.

Pulse Voltage

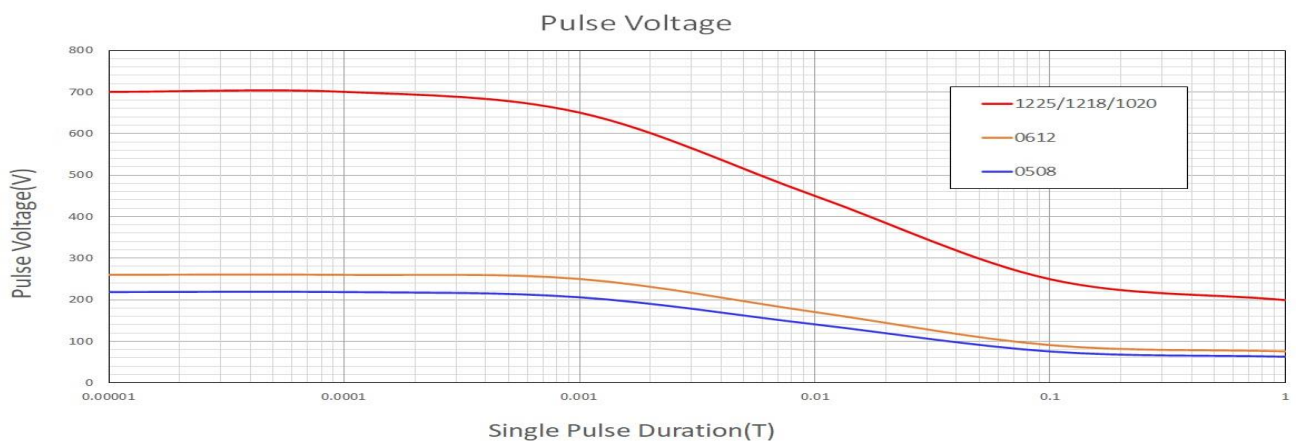

Pulse Voltage; applicable rate power at 70°C and Max working voltage and Max overload voltage.



CRW Series Thick Film Wide Terminal Chip Resistor Product Specifications

Document No.	S-10-12-19-15
Released Date	2023/06/17
Page No.	7/13

■ Power Derating Curve

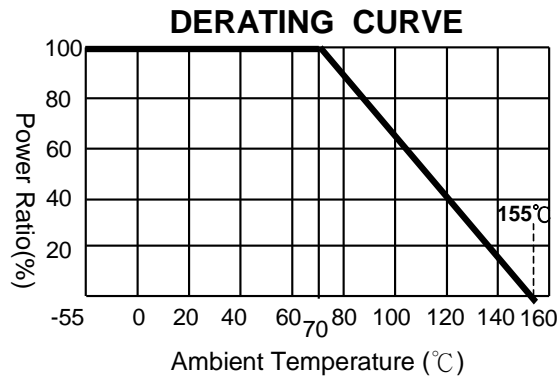

Power rating or current rating is in the case based on continuous full-load at ambient temperature of 70°C. For operation at ambient temperature in excess of 70°C, the load should be derated in accordance with figure of derating Curve.

■ Voltage Rating or Current Rating

Resistance Range: $\geq 1\Omega$

Rated Voltage: The resistor shall have a DC continuous working voltage or a RMS AC continuous working voltage at commercial-line frequency and wave form corresponding to the power rating, as determined formula as following:

$$E(RCWV) = \sqrt{P \times R}$$

E=Rated voltage(V)

P=Power rating(W)

R=Nominal resistance(Ω)



CRW Series Thick Film Wide Terminal Chip Resistor Product Specifications

Document No.	S-10-12-19-15
Released Date	2023/06/17
Page No.	8/13

Reliability Test and Requirement

Test Item	Test Method	Procedure	Requirements
Temperature Coefficient of Resistance (T.C.R)	JIS-C-5201-1 4.8 IEC-60115-1 4.8	At 25°C / -55°C and 25°C / +155°C, 25°C is the reference temperature	As Spec
Short Time Overload	JIS-C-5201-1 4.13 IEC-60115-1 4.13	Z:6.25*Rated power or Max Overload voltage whichever is less for 5 seconds. H:5*Rated power or Max Overload voltage whichever is less for 5 seconds. Jumper : Over Load Current for 5 seconds 0612=10A / 1020=15A / 1218=15A 1225=20A	1% and below : ±(1.0%+0.05Ω) 2%、5% : ±(2.0%+0.10Ω) Jumper : Max 0.02Ω after test.
Leaching	JIS-C-5201-1 4.18 IEC-60068-2-58 8.2.1	260±5°C for 30 seconds.	Individual leaching area ≤5% Total leaching area ≤ 10%
Resistance to Soldering Heat	JIS-C-5201-1 4.18 IEC-60115-1 4.18	260±5°C for 10 seconds.	1% and below : ±(0.5%+0.05Ω) 2%、5% : ±(1.0%+0.05Ω)
Rapid Change of Temperature	JIS-C-5201-1 4.19 IEC-60115-1 4.19	-55°C to +155°C, 5 cycles	1% and below : ±(0.5%+0.05Ω) 2%、5% : ±(1.0%+0.10Ω)
Resistance to Solvent	JIS-C-5201-1 4.29	The tested resistor be immersed into isopropyl alcohol of 20~25°C for 60 secs. Then the resistor is left in the room for 48 hrs.	1% and below : ±(0.5%+0.05Ω) 2%、5% : ±(0.5%+0.05Ω) Jumper : Max 0.02Ω after test.
Damp Heat with Load	JIS-C-5201-1 4.24 IEC-60115-1 4.24	40±2°C, 90~95% R.H. RCWV or Max. working voltage whichever is less for 1000 hrs with 1.5 hrs "ON" and 0.5 hrs "OFF" .	1% and below : ±(1.0%+0.05Ω) 2%、5% : ±(2.0%+0.05Ω) Value <1Ω : ±(2.0%+0.05Ω) Jumper : Max 0.05Ω after test.
Load Life (Endurance)	JIS-C-5201-1 4.25 IEC-60115-1 4.25.1	70±2°C, RCWV or Max. working voltage whichever is less for 1000 hrs with 1.5 hrs "ON" and 0.5 hr "OFF" .	1% and below : ±(1.0%+0.05Ω) 2%、5% : ±(3.0%+0.10Ω) Value <1Ω : ±(3.0%+0.10Ω) Jumper : Max 0.05Ω after test.
Insulation Resistance	JIS-C-5201-1 4.6 IEC-60115-1 4.6	Apply 100VDC for 1 minute.	≥ 10GΩ
Bending Strength	JIS-C-5201-1 4.33 IEC-60115-1 4.33	Bending once for 5 seconds D : 0508、0612、1020、1218、1225=2mm	1% and below : ±(1.0%+0.05Ω) 2%、5% : ±(1.0%+0.05Ω)

Recommended Customer Soldering Parameters

Wave solder Temperature condition

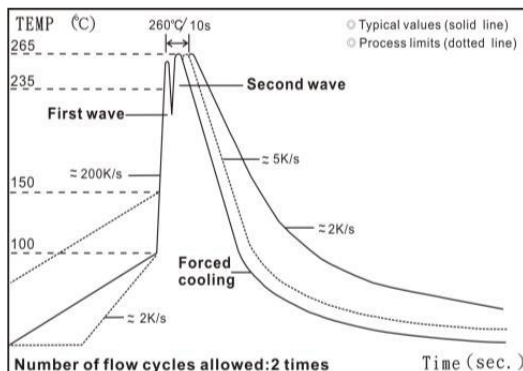

■ **Solder reflow Temperature condition**

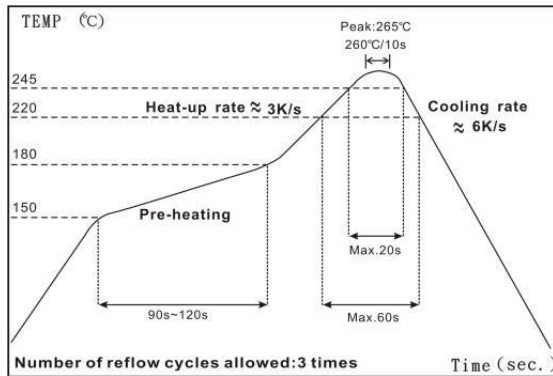

■ **Rework temperature (hot air equipment) : 350°C, 3~5seconds**

■ **Recommended reflow methods**

IR, vapor phase oven, hot air oven

If reflow temperatures exceed the recommended profile, devices may not meet the performance requirements.

■ **Appendix For SMD Chip Resistor**

● **Packaging Information**

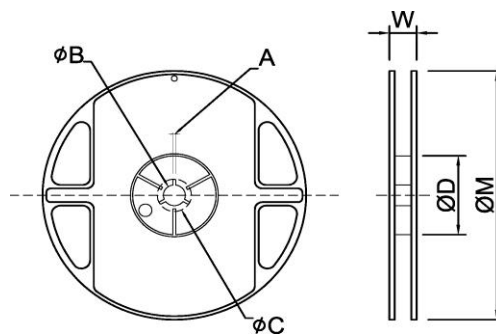

■ **Dimension**

Unit: mm

Type	Size	A	φB	φC	φD	W	φM
0508/0612	7" 5K/Reel	2.0±0.5	13.5±1.0	21±1.0	60±1.0	11.5±2.0	178±2.0
1020/1218/1225	7" 4K/Reel	2.0±0.5	13.5±1.0	21±1.0	60±1.0	16.0±2.0	178±2.0

■ Tapping Specification

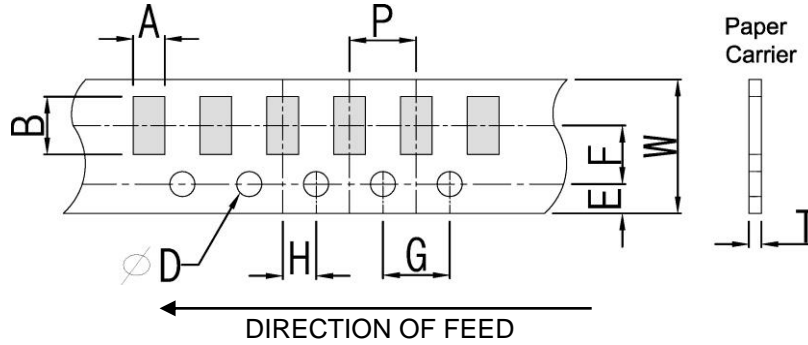

■ Dimension

Unit: mm

Packaging	Type	A	B	W	E	F	G	H	T	ϕD	P
Paper Type	0508	1.50±0.15	2.25±0.15	8.0±0.2	1.75±0.1	3.5±0.05	4.0±0.1	2.0±0.05	0.75±0.1	1.50 ^{+0.10} ₋₀	4.0±0.1
	0612	1.90±0.2	3.50±0.2	8.0±0.2	1.75±0.1	3.5±0.05	4.0±0.1	2.0±0.05	0.75±0.1		4.0±0.1

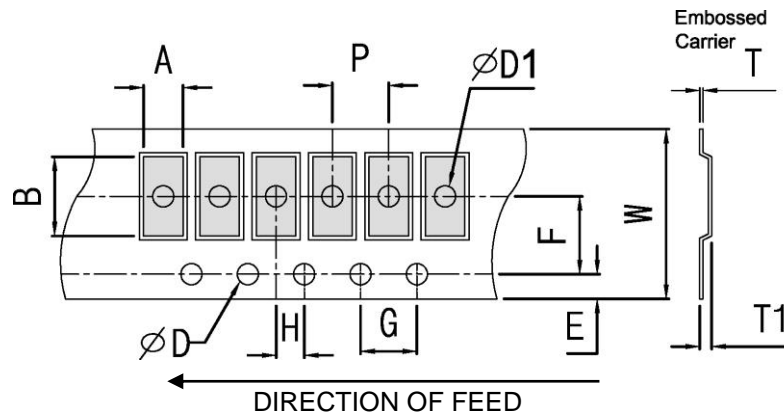

■ Dimension

Unit: mm

Packaging	Type	A	B	W	E	F	G	H	T	ϕD	$\phi D1$	T1	P
Embossed Type	1020	2.80±0.2	5.60±0.2	12±0.1	1.75±0.1	5.5±0.05	4.0±0.1	2.0±0.05	0.23±0.1	1.50 ^{+0.10} ₋₀	1.50±0.1	0.85±0.15	4.0±0.1
	1225*Z	3.40±0.2	6.70±0.2	12±0.1	1.75±0.1	5.5±0.05	4.0±0.1	2.0±0.05	0.23±0.1		1.50±0.1	0.85±0.15	
	1225*H	3.40±0.2	6.70±0.2	12±0.1	1.75±0.1	5.5±0.05	4.0±0.1	2.0±0.05	0.23±0.1		1.50±0.1	1.0±0.15	
	1218	3.30±0.2	4.60±0.2	12±0.1	1.75±0.1	5.5±0.05	4.0±0.1	2.0±0.05	0.23±0.1		1.50±0.1	0.85±0.15	



CRW Series Thick Film Wide Terminal Chip Resistor Product Specifications

Document No.	S-10-12-19-15
Released Date	2023/06/17
Page No.	11/13

■ Packing Material Data/Storage Data

■ Front & Back Lead Dimension

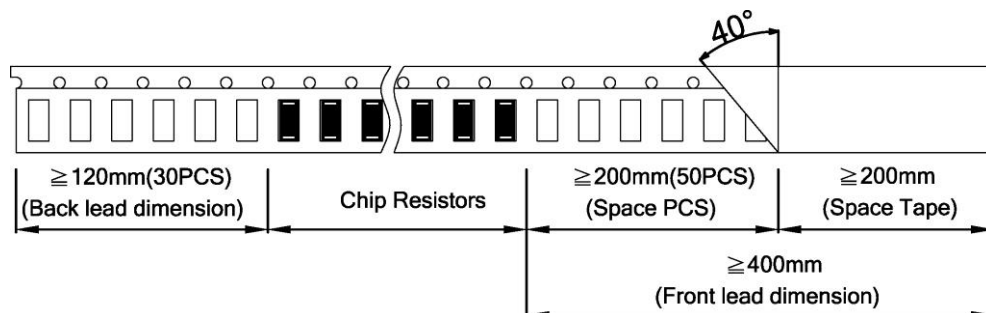

■ Top Adhesive Peel Off Strength : 10~70g

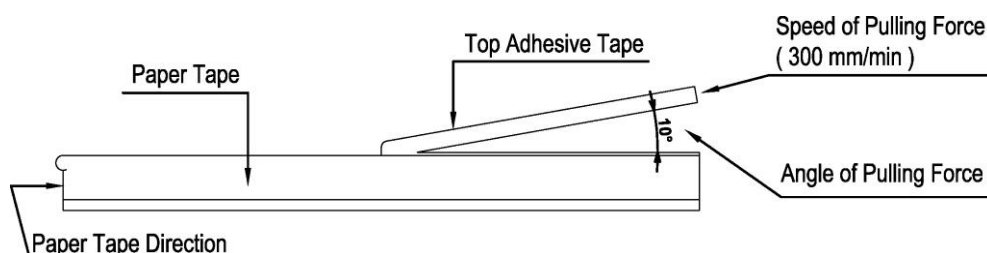

■ Package

Inner Box Size	
Reel	Size H(mm)
1	13
2	24
3	36
5	60
10	113

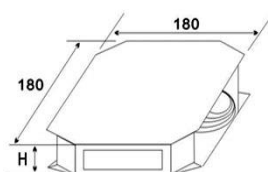

External Box Size			
Contain (Kpcs)	Length (mm)	Width (mm)	Height (mm)
25K	180	180	60
50K	180	180	110
150K	430	200	200
300K	400	400	200

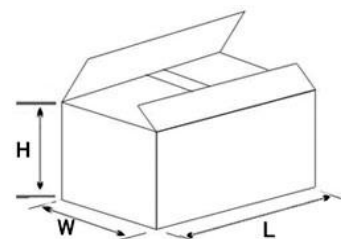

■ Storage Data :

Storage time at the environment temp: $25 \pm 5^\circ\text{C}$ & humidity: $60 \pm 20\%$ is valid for one year from the date of delivery.

■ Product Testing Method:

Our products are tested with our company's tapping & testing equipments by using four-feet probe to touch at the back of both electrodes. Supposed different testing points or methods are requested, please advise beforehand and customized-made production is available.



CRW Series Thick Film Wide Terminal Chip Resistor Product Specifications

Document No.	S-10-12-19-15
Released Date	2023/06/17
Page No.	12/13

Standard Resistance Values in a Decode

Marking code:

- CRW0508:No Marking
- 1%: marking code, please refer to E96 and E24 data form as below
 Ex: 120K, The marking code is 1203 in E24
 121K, The marking code is 1213 in E96
- 5%: marking code, please refer to E24 data form as below
 Ex: 120K, The marking code is 124 in E24
- Note: jumper zero ohm resistor marking code is one 「0」.

E96	E48	E96	E48	E96	E48	E96	E48	E96	E48				
100	100	169	169	287	287	487	487	825	825				
102		174		294		499		845					
105	105	178	178	301	301	511	511	866	866				
107		182		309		523		887					
110	110	187	187	316	316	536	536	909	909				
113		191		324		549		931					
115	115	196	196	332	332	562	562	953	953				
118		200		340		576		976					
121	121	205	205	348	348	590	590						
124		210		357		604		E24	E12	E6	E3		
127	127	215	215	365	365	619	619	10	10	10	10		
130		221		374		634		11					
133	133	226	226	383	383	649	649	12	12				
137		232		392		665		13					
140	140	237	237	402	402	681	681	15	15	15			
143		243		412		698		16					
147	147	249	249	422	422	715	715	18	18				
150		255		432		732		20					
154	154	261	261	442	442	750	750	22	22	22	22		
158		267		453		768		24					
162	162	274	274	464	464	787	787	27	27				
165		280		475		806		30					
								33	33	33			
								36					
								39	39				
								43					
								47	47	47	47		
								51					
								56	56				
								62					
								68	68	68			
								75					
								82	82				
								91					

According to IEC publication 63



CRW Series Thick Film Wide Terminal Chip Resistor Product Specifications

Document No.	S-10-12-19-15
Released Date	2023/06/17
Page No.	13/13

■ mΩ Resistance Codes

Resistance	Code	Resistance	Code	Resistance	Code	Resistance	Code
10mΩ	R010	70mΩ	R070	0.18Ω	R180	0.47Ω	R470
15mΩ	R015	75mΩ	R075	0.20Ω	R200	0.50Ω	R500
20mΩ	R020	80mΩ	R080	0.22Ω	R220	0.56Ω	R560
30mΩ	R030	90mΩ	R090	0.25Ω	R250	0.60Ω	R600
40mΩ	R040	0.10Ω	R100	0.27Ω	R270	0.65Ω	R650
50mΩ	R050	0.11Ω	R110	0.30Ω	R300	0.68Ω	R680
56mΩ	R056	0.12Ω	R120	0.33Ω	R330	0.70Ω	R700
60mΩ	R060	0.13Ω	R130	0.36Ω	R360	0.75Ω	R750
65mΩ	R065	0.15Ω	R150	0.40Ω	R400	0.80Ω	R800
68mΩ	R068	0.16Ω	R160	0.43Ω	R430	0.90Ω	R900

单击下面可查看定价，库存，交付和生命周期等信息

[>>EVER OHMS\(天二\)](#)