

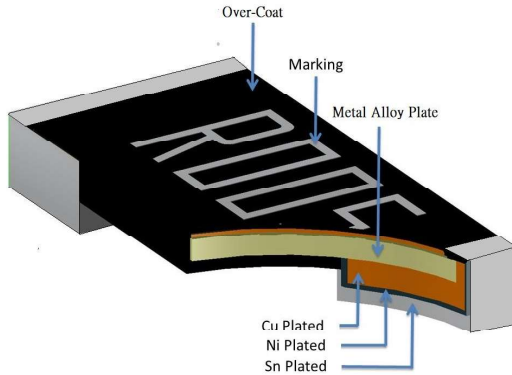

MA Series Metal Alloy Low-Resistance Resistor Product Specifications

Document No.	S-10-12-05-19
Revision Date	2020/04/28
Page No.	1/10

■ Metal Alloy Low Resistance Chip Resistor — MA Series



■ Application

- Entertainment product
- Power supply
- Measuring instrument
- Industrial product
- Battery management system

■ Features

- Low Resistance / Low TCR
- Excellent long term stability
- RoHs compliant and halogen free.
- Lead free.
- High precision current sensing and voltage division.

■ Parts Number Explanation

■ Example:

MA	2512	20	F	R001	M	Z
Product Type	Size (Inch)	Rated Power	Tolerance	Resistance	Material	Optional
	1206 2512 2725 2728 4527	07= 0.75 W 10= 1.00 W 20= 2.00 W 30= 3.00 W 40= 4.00 W 50= 5.00 W	D : ±0.5 % F : ±1 % G : ±2 % J : ±5 %	0m20= 0.2 mR 2m50= 2.5 mR R000= 0 mR R005= 5.0 mR R100= 100 mR R500= 500 mR	S : MnCuSn M : MnCu F : FeCrAl C : Cu	Z : Default code



MA Series Metal Alloy Low-Resistance Resistor Product Specifications

Document No.	S-10-12-05-19
Revision Date	2020/04/28
Page No.	2/10

Standard Electrical Specifications

TYPE	Rating Power at 70°C	T.C.R. (ppm/°C)	Max. Rating Current	Max. Overload Current	Resistance Range (mΩ)		Material	Operating Temperature Range (°C)
					0.5% (D)	1.0% (F) 2.0% (G) 5.0% (J)		
MA1206	0.75W	≤±50	3.83	7.66	51~100	51~100	R051~R100 : FeCrAl	-55~+170°C
	1W		31.62	63.24	7~50	1~50	R001 : MnCuSn R002~R007 : MnCu R008~R050 : FeCrAl	
	1.5W		38.72	77.49	7~10	1~10	R001 : MnCuSn R002~R007 : MnCu R008~R010 : FeCrAl	
MA2512	1W	≤±75	44.72	100.00	---	0.5~0.75	R0005~R00075 : MnCuSn	
	1W	≤±50	31.62	70.71	7~450	1~450	R001~R006 : MnCu R007~R450 : FeCrAl	
	2W	≤±75	63.24	141.42	---	0.5~0.75	R0005~R00075 : MnCuSn	
	2W	≤±50	44.72	100.00	7~450	1~450	R001~R006 : MnCu R007~R450 : FeCrAl	
	3W	≤±75	77.45	154.91	---	0.5~0.75	R0005~R00075 : MnCuSn	
	3W	≤±50	54.77	109.54	7~100	1~100	R001~R006 : MnCu R007~R100 : FeCrAl	
MA2725	4W	≤±75	126.49	252.98	---	0.25~0.3	R00025~R0003 : MnCuSn	
		≤±50	89.44	178.88		0.5~3	R0005~R0025 : MnCu R003 : FeCrAl	
MA2728	4W	≤±50	31.62	63.24	7~450	4~450	R004~R450 : FeCrAl	
MA4527	2W	≤±75	63.24	141.42	---	0.5	R0005 : MnCuSn	
	2W	≤±50	44.72	100.00	7~100	1~100	R001~R005 : MnCu R006~R100 : FeCrAl	
	3W	≤±75	77.45	173.20	---	0.5	R0005 : MnCuSn	
	3W	≤±50	54.77	122.47	7~60	1~60	R001~R005 : MnCu R006~R060 : FeCrAl	
	5W	≤±75	100.00	173.20	---	0.5	R0005 : MnCuSn	
	5W	≤±50	70.71	122.47	7~500	1~500	R001~R005 : MnCu R006~R500 : FeCrAl	



MA Series Metal Alloy Low-Resistance Resistor Product Specifications

Document No.	S-10-12-05-19
Revision Date	2020/04/28
Page No.	3/10

Jumper Specifications

Type	Rating Power at 70°C	Max. Rating Current	Resistance (mΩ)	Material	Operating Temperature Range (°C)
MA1206	1W	70.7A	≤0.2	Jumper : Cu	-55~+170°C
MA2512	2W	100A			

Type Dimension

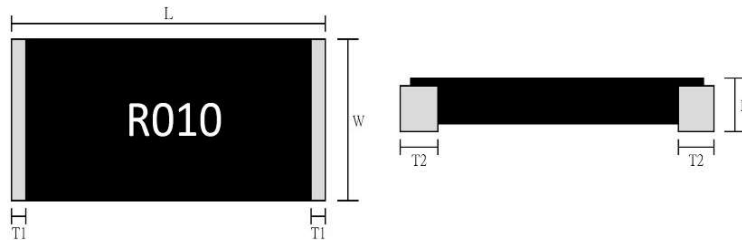

FOR MA1206~4527

Dimension

Unit : mm

Type	Power Rating	Resistance Range	L	W	H	T1	T2
MA1206	0.75W	51~75mΩ	3.200±0.254	1.650±0.254	0.400±0.254	0.508±0.254	0.508±0.254
		76~100mΩ			0.350±0.254		
	1W	1mΩ			0.770±0.254		
		2mΩ			0.650±0.254		
		3~20mΩ			0.550±0.254		
		21~50mΩ			0.470±0.254		
	1.5W	1mΩ			0.770±0.254		
		2mΩ			0.650±0.254		
		3~10mΩ			0.550±0.254		
MA2512	1W 2W	0.5mΩ	6.350±0.254	3.050±0.254	0.770±0.254	1.15±0.254	2.200±0.254
		0.75 mΩ			0.650±0.254		1.980±0.254
		1mΩ					2.200±0.254
		1.5mΩ			0.670±0.254		1.400±0.254
		2mΩ					1.150±0.254
		2.5~6mΩ			0.550±0.254		
		7~10mΩ			0.600±0.254		
		11~75mΩ			0.600±0.254	1.05±0.254	
		76~100mΩ			0.550±0.254	0.75±0.254	1.100±0.254
		101~135mΩ			0.470±0.254		
		136~200mΩ					
		201~450mΩ			0.400±0.254		



MA Series Metal Alloy Low-Resistance Resistor Product Specifications

Document No.	S-10-12-05-19
Revision Date	2020/04/28
Page No.	4/10

Type	Power Rating	Resistance Range	L	W	H	T1	T2
MA2512	3W	0.5mΩ	6.350±0.254	3.050±0.254	0.770±0.254	1.150±0.254	2.200±0.254
		0.75mΩ			0.650±0.254		1.980±0.254
		1mΩ			0.670±0.254		2.200±0.254
		1.5mΩ				1.400±0.254	
		2mΩ			0.75±0.254	1.150±0.254	
		2.5~6mΩ				0.550±0.254	1.100±0.254
		7~75mΩ				0.600±0.254	
		76~100mΩ				0.550±0.254	
MA2725	4W	0.25mΩ	6.800±0.254	6.350±0.254	0.770±0.254	1.15±0.254	
		0.3mΩ			0.650±0.254		1.800±0.254
		0.5mΩ					2.300±0.254
		1mΩ			0.550±0.254	1.800±0.254	
		1.5mΩ				1.500±0.254	
		2~3mΩ					
MA2728	4W	4~450mΩ	6.600±0.254	6.700±0.254	0.580±0.254	0.40±0.254	1.050±0.254
MA4527	2W	0.5mΩ	11.300±0.500	6.600±0.500	0.770±0.254	0.90±0.254	3.000±0.254
		1mΩ			0.650±0.254		2.000±0.254
		1.5~5mΩ					0.550±0.254
		6~100mΩ					
	3W	0.5mΩ			0.90±0.254	3.000±0.254	
		1mΩ				0.650±0.254	2.000±0.254
		1.5~5mΩ					0.550±0.254
		6~60mΩ					
	5W	0.5mΩ			0.65±0.254	3.000±0.254	
		1mΩ				0.800±0.254	2.000±0.254
		1.5~5mΩ					
		6~450mΩ				0.680±0.254	
					0.580±0.254		

Jumper Dimension

Unit : mm

Type	Power Rating	Resistance Range	L	W	H	T1	T2
MA1206	1W	< 0.2mΩ	3.200±0.254	1.650±0.254	0.650±0.254	0.508±0.254	0.508±0.254
MA2512	2W	< 0.2mΩ	6.350±0.254	3.050±0.254	0.650±0.254	1.15±0.254	1.100±0.254



MA Series Metal Alloy Low-Resistance Resistor Product Specifications

Document No.	S-10-12-05-19
Revision Date	2020/04/28
Page No.	5/10

■ Performance Characteristics

Power Derating Curve

The Operating Temperature Range: $-55^{\circ}\text{C} \sim +170^{\circ}\text{C}$.

For resistors operated in ambient temperatures above 70°C , power rating must be derating in accordance with the curve below.

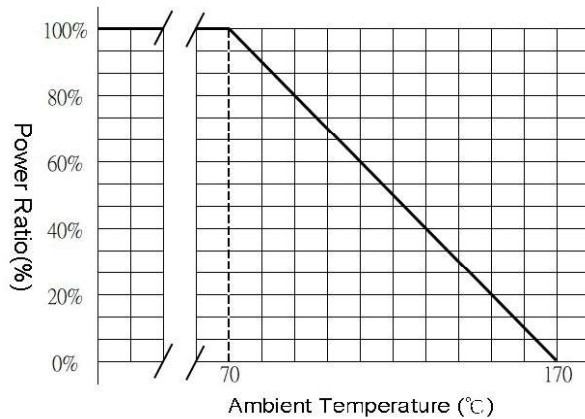

■ Rating Current

The following equation may be used to determine the DC (Direct Current) or AC (Alternating Current) (RMS, root mean square value) of normal rated power. However, if the result value exceeds the highest current of regulated standards (paragraph 5), the highest normal rated power is to be used.

$$I = \sqrt{P/R}$$

I = Rating current (A)
P = Rating Power (W)
R = Resistance (Ω)

■ Marking Format:

- All the other products marking are 4 digits.
- "R" designates the decimal location in ohms
e.g. $1\text{m}\Omega$ the product marking is R001.
 $25\text{m}\Omega$ the product marking is R025.
 $100\text{m}\Omega$ the product marking is R100.
- "m" designates the decimal location in milli-ohms
e.g. $0.25\text{m}\Omega$ the product marking is 0m25.
 $0.5\text{m}\Omega$ the product marking is 0m50.
 $5.5\text{m}\Omega$ the product marking is 5m50.
 $25.5\text{m}\Omega$ the product marking is 25m5.
- 0Ω product marking is 0R.
- The criteria to distinguishing the mark on the surface of products are that characters can be identified.



MA Series Metal Alloy Low-Resistance Resistor Product Specifications

Document No.	S-10-12-05-19
Revision Date	2020/04/28
Page No.	6/10

■ Reliability test and requirement

Test Item	Test Method	Procedure	Requirements
Temperature Coefficient of Resistance (T.C.R)	JIS-C-5201-1 4.8 IEC-60115-1 4.8	At 25°C /+150°C, 25°C is the reference temperature	As Spec
Short Time Overload	JIS-C-5201-1 4.13 IEC-60115-1 4.13	The number of rated power are as follows: <ul style="list-style-type: none"> MA1206-0.75W: 4 times of rated power MA1206-1W: 4 times of rated power MA1206-1.5W: 4 times of rated power MA2512-1W: 5 times of rated power MA2512-2W: 5 times of rated power MA2512-3W: 4 times of rated power MA2725-4W: 4 times of rated power MA2728-4W: 4 times of rated power MA4527-2W: 5 times of rated power MA4527-3W: 5 times of rated power MA4527-5W: 3 times of rated power for 5 seconds. 	<ul style="list-style-type: none"> MA4527: $\Delta R/R1 \leq \pm 2.0\%$ The others: $\Delta R/R1 \leq \pm 0.5\%$
High Temperature Exposure	JIS-C5201-1 4.25 IEC 60068-2-2	At 170°C for 1000 hours.	<ul style="list-style-type: none"> MA4527: $\Delta R/R1 \leq \pm 2.0\%$ The others: $\Delta R/R1 \leq \pm 1.0\%$
Resistance to Soldering Heat	JIS-C-5201-1 4.18 IEC-60115-1 4.18	260±5°C for 10 seconds.	$\Delta R/R1 \leq \pm 0.5\%$
Temperature Cycling	JESD22 Method JA-104	1000 Cycles (-55°C to +155°C) Measurement at 24±4 hours after test conclusion. 30min maximum dwell time at each temperature extreme.	$\Delta R/R1 \leq \pm 0.5\%$
Biased Humidity	MIL-STD-202 Method 103	1,000 hours; 85°C / 85% RH, 10% of operating power. Measurement at 24±4 hours after test conclusion.	$\Delta R/R1 \leq \pm 0.5\%$
Load Life (Endurance)	JIS-C-5201-1 4.25 IEC-60115-1 4.25.1	70±2°C, RCWW or Max. working voltage whichever is less for 1000 hrs with 1.5 hrs "ON" and 0.5 hr "OFF" .	<ul style="list-style-type: none"> MA4527: $\Delta R/R1 \leq \pm 2.0\%$ The others: $\Delta R/R1 \leq \pm 1.0\%$
Solderability	JIS-C-5201-1 4.17 IEC-60115-1 4.17	245±5°C for 3 seconds.	>95% coverage
Dielectric Withstanding Voltage	JIS-C5201-1 4.7	Applied 500VAC for 1 minute.	No short or burned on the appearance.
Core Body Strength	JIS-C5201-1 4.15	Central part pressurizing force : 5N , 10 seconds	No broken
Terminal Strength (SMD)	AEC Q200-006	Pressurizing force 17.7N for 60 seconds	No broken
Bending Strength	JIS-C-5201-1 4.33 IEC-60115-1 4.33	Bending once 2mm for 10 seconds	$\Delta R/R1 \leq \pm 0.5\%$ No broken
Moisture Resistance	MIL-STD 202 Method 106	T=24 hours / Cycle , 10Cycles . Steps 7a& 7b not required. Unpowered . (Figure 1)	$\Delta R/R1 \leq \pm 0.5\%$



MA Series Metal Alloy Low-Resistance Resistor Product Specifications

Document No.	S-10-12-05-19
Revision Date	2020/04/28
Page No.	7/10

For Jumper

Test Item	Test Method	Procedure	Requirements
Short Time Overload	JIS-C-5201-1 4.13 IEC-60115-1 4.13	4 times of rated power for 5 seconds.	$\leq 0.2m\Omega$
Temperature Cycling	JESD22 Method JA-104	1000 Cycles (-55°C to +155°C) Measurement at 24±4 hours after test conclusion. 30min maximum dwell time at each temperature extreme.	$\leq 0.2m\Omega$
High Temperature Exposure	JIS-C5201-1 4.25 IEC 60068-2-2	At 170°C for 1000 hours.	$\leq 0.2m\Omega$
Biased Humidity	MIL-STD-202 Method 103	1,000 hours; 85°C / 85% RH, 10% of operating power. Measurement at 24±4 hours after test conclusion.	$\leq 0.2m\Omega$
Load Life (Endurance)	JIS-C-5201-1 4.25 IEC-60115-1 4.25.1	70±2°C, RCWV or Max. working voltage whichever is less for 1000 hrs with 1.5 hrs "ON" and 0.5 hr "OFF" .	$\leq 0.2m\Omega$
Solderability	JIS-C-5201-1 4.17 IEC-60115-1 4.17	245±5°C for 3 seconds.	>95% coverage

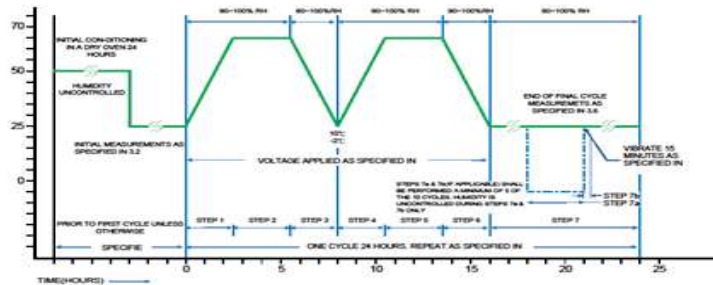
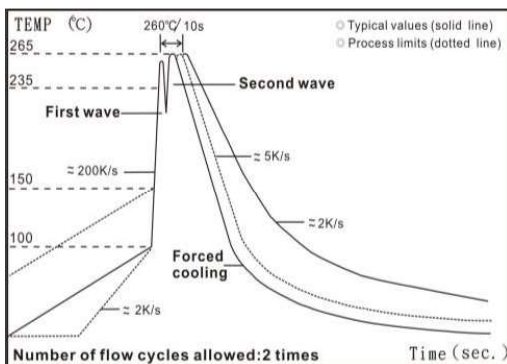

Figure 1

Recommended Customer Soldering Parameters

Wave solder Temperature condition





MA Series Metal Alloy Low-Resistance Resistor Product Specifications

Document No.	S-10-12-05-19
Revision Date	2020/04/28
Page No.	8/10

Solder reflow Temperature condition

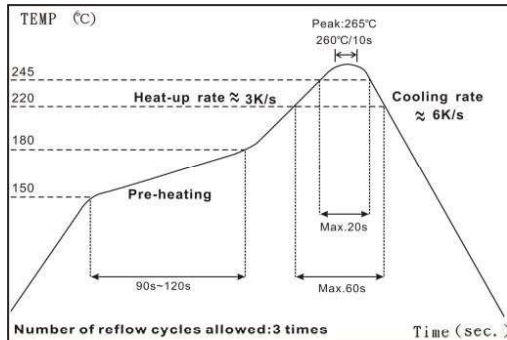

Recommend Land Pattern Design

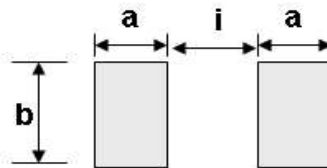

Dimension

Unit: mm

TYPE	Resistance Range	a	b	i
MA1206 – 0.75W, 1W, 1.5W	Jumper : $\leq 0.2m\Omega$	1.46	2.15	1.68
	1m Ω ~100m Ω	1.46	2.15	1.68
MA2512 -1W, 2W, 3W	Jumper : $\leq 0.2m\Omega$	2.30	3.68	3.15
	0.5m Ω ~1m Ω	3.40	3.68	0.95
	1.5 m Ω	2.35	3.68	1.35
	2 m Ω	2.10	3.68	2.55
	2.5m Ω ~200m Ω	2.30	3.68	3.15
	201m Ω ~450m Ω	2.05	3.68	3.65
MA2725 - 4W	0.25m Ω : 0.5m Ω	3.25	6.85	1.70
	0.3m Ω : 1m Ω ~3m Ω	2.75	6.85	2.70
MA2728 - 4W	4m Ω ~450m Ω	2.05	7.20	3.90
MA4527 – 2W, 3W, 5W	0.5m Ω ~1.5m Ω	4.50	8.74	4.50
	2.0m Ω ~100m Ω	3.50	8.74	6.50
	101m Ω ~500m Ω	3.50	8.74	6.50



MA Series Metal Alloy Low-Resistance Resistor Product Specifications

Document No.	S-10-12-05-19
Revision Date	2020/04/28
Page No.	9/10

■ Packing Quantity

TYPE	PCS /Reel	Parts Number Explanation
MA1206	5000	Z: 5000PCS
MA1206- 001	4000	Z: 4000PCS
MA2512	4000	Z: 4000PCS
MA2725	2000 /1000	Z: 2000PCS 1: 1000PCS
MA2728	2000 / 1000	Z: 2000PCS 1: 1000PCS
MA4527	1000 / 500	Z: 1000PCS 0: 500PCS

■ Plating Thickness:

Ni: $\geq 2 \mu\text{m}$

Sn(Tin): $\geq 3 \mu\text{m}$

■ Label :





MA Series Metal Alloy Low-Resistance Resistor Product Specifications

Document No.	S-10-12-05-19
Revision Date	2020/04/28
Page No.	10/10

Appendix For SMD Chip Resistor

Packaging Information

Reel Dimensions

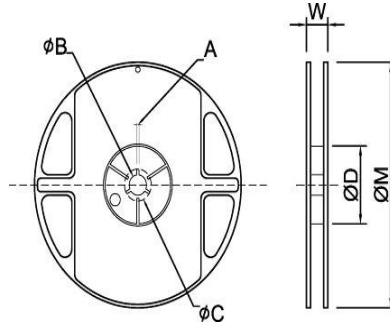

Dimension

Unit: mm

Reel Type / Tape	A	φ B	φ C	φ D	W	φ M
7" reel for 8 mm embossed (for MA1206)	2.0±0.5	13.2±0.5	17.7±0.5	60.0±0.5	12.0±0.5	178±1.0
7" reel for 12 mm embossed	2.5±0.5	13.5±0.5	17.7±0.5	60.0±0.5	16.2±0.5	178±1.0
7" reel for 24 mm embossed	2.0±0.5	13.2±0.5	17.7±0.5	60.0±0.5	24.4±2.0	178±1.0

Embossed Dimensions

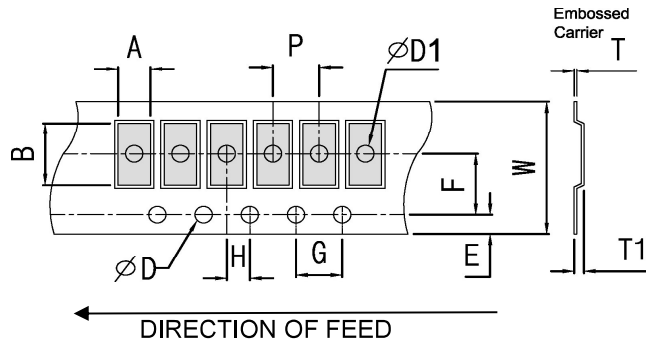

Dimension

Unit: mm

Item	Resistance Range (mΩ)	W	P	E	F	φ D	φ D1	G	H	A	B	T1	T
MA1206	1mΩ	8.0±0.30	4.0±0.10	1.75±0.10	3.5±0.10	1.50 ^{+0.1} ₀	1.0±0.10	4.0±0.10	2.0±0.10	2.03±0.10	3.55±0.10	1.10±0.10	0.20±0.05
MA1206	2~100mΩ	8.0±0.30	4.0±0.10	1.75±0.10	3.5±0.10		1.0±0.10	4.0±0.10	2.0±0.10	2.03±0.10	3.55±0.10	0.85±0.10	0.20±0.05
MA2512	0.5~2mΩ	12.0±0.30	4.0±0.10	1.75±0.10	5.5±0.10		1.55±0.10	4.0±0.10	2.0±0.10	3.50±0.10	6.75±0.10	1.10±0.10	0.20±0.05
MA2512	3~450mΩ	12.0±0.30	4.0±0.10	1.75±0.10	5.5±0.10		1.55±0.10	4.0±0.10	2.0±0.10	3.50±0.10	6.75±0.10	0.90±0.10	0.20±0.05
MA2725	0.25~3mΩ	12.0±0.30	8.0±0.10	1.75±0.10	5.5±0.10		1.55±0.10	4.0±0.10	2.0±0.10	6.81±0.10	7.16±0.10	1.05±0.10	0.25±0.05
MA2728	4~450mΩ	12.0±0.30	8.0±0.10	1.75±0.10	5.5±0.10		1.55±0.10	4.0±0.10	2.0±0.10	7.10±0.10	7.05±0.10	0.95±0.10	0.20±0.05
MA4527	0.5~500mΩ	24.0±0.30	12.0±0.10	1.75±0.10	11.5±0.10		1.50±0.10	4.0±0.10	2.0±0.10	7.38±0.10	12.0±0.10	1.05±0.10	0.30±0.10

Storage Temperature

Storage time at the environment temp: 25±5°C & humidity: 60±20% is valid for one year from the date of delivery

单击下面可查看定价，库存，交付和生命周期等信息

[>>天二](#)