

150mA, Low Power Consumption, High Voltage CMOS LDO Regulator

FEATURES

- **Low Quiescent Current I_Q :**
11 μ A Typical at Light Loads
18 μ A Maximum at Light Loads
- **150mA Nominal Output Current**
- **Low Dropout Voltage**
- **Low Temperature Coefficient**
- **High Input Voltage (up to 36V)**
- **Output Voltage Accuracy: $\pm 2.5\%$**
- **Fixed 3.0V, 3.3V, 3.6V, 4.36V and 5.0V Output Voltage**
- **Operating Temperature Range: -40°C to +85°C**
- **Micro SIZE PACKAGES: SOT23-3, SOT23, SOT23-5, SOT89-3L and SOT89-3L(L-Type)**

APPLICATIONS

- **Audio/Video Equipment**
- **Communication Equipment**
- **Battery-Powered Equipment**
- **Automotive Head Unit**
- **Laptop, Palmtops, Notebook Computers**

DESCRIPTION

The RS3005 series is a set of low power high voltage regulators implemented in CMOS technology. It can operate from 2.5V to 36V. Which can provide 150mA output current. The device allows input voltage as high as 36V.

The RS3005 series is available in several fixed output voltages. CMOS technology ensures low dropout voltage and ultralow quiescent current.

The RS3005 is available in Green SOT23-3, SOT23, SOT23-5, SOT89-3L and TO-92 packages. It operates over an ambient temperature range of -40°C to +85°C.

Device Information (1)

PART NUMBER	PACKAGE	BODY SIZE (NOM)
RS3005	SOT23-3(3)	1.60mm × 2.92mm
	SOT23(3)	1.30mm × 2.92mm
	SOT23-5(5)	1.60mm × 2.92mm
	SOT89-3L(3)	2.45mm × 4.50mm
	TO-92(3)	4.60mm × 4.60mm

(1) For all available packages, see the orderable addendum at the end of the data sheet.

Typical Application Schematic

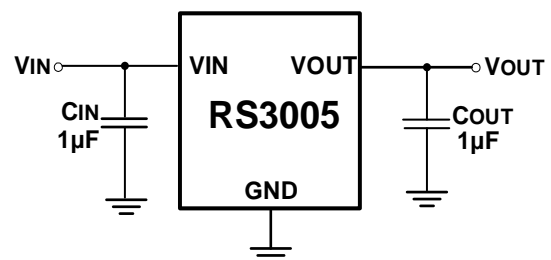

Pin Configuration and Functions (Top View)

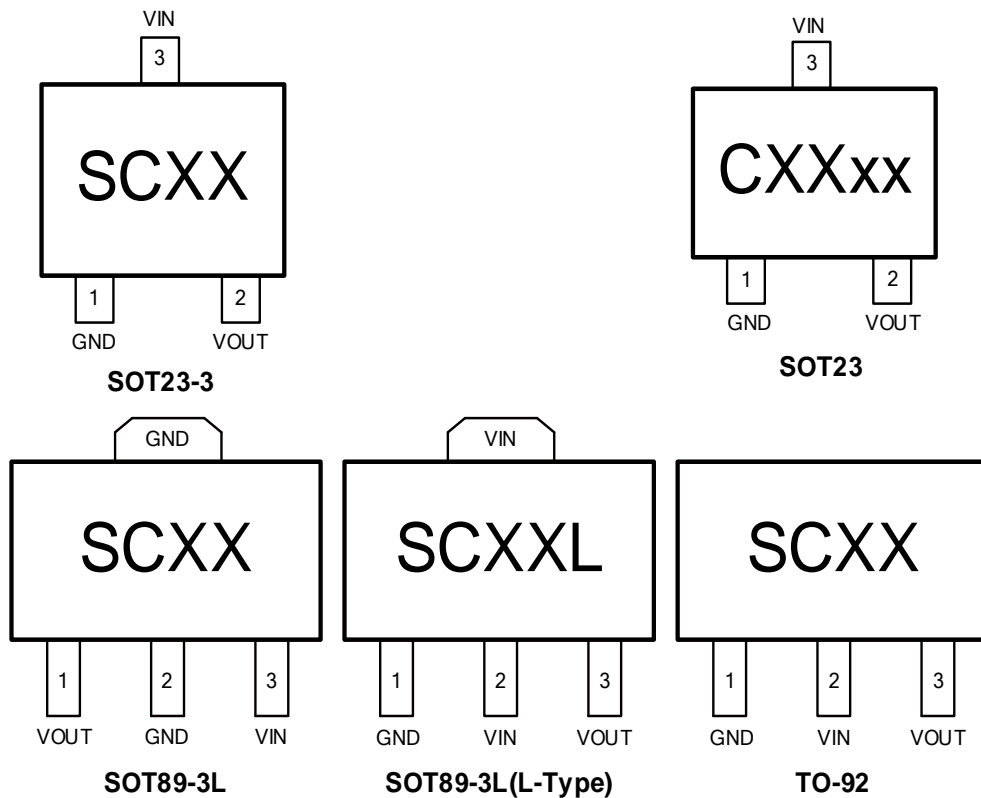

NOTE: XX indicate Output Voltage, xx indicate Data Code
 For example: SC33 ($V_{OUT}=3.3V$)

PIN DESCRIPTION

NAME	PIN				FUNCTION
	SOT23-3	SOT23	SOT89-3L	SOT89-3L (L-Type) /TO-92	
GND	1	1	2	1	Ground.
VOUT	2	2	1	3	Regulator Output. Recommended output capacitor range: $1\mu F$ to $10\mu F$.
VIN	3	3	3	2	Regulator Input. Up to 36V input voltage. At least $1\mu F$ supply bypass capacitor is recommended.

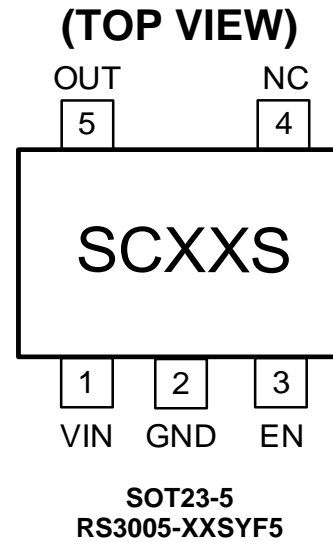
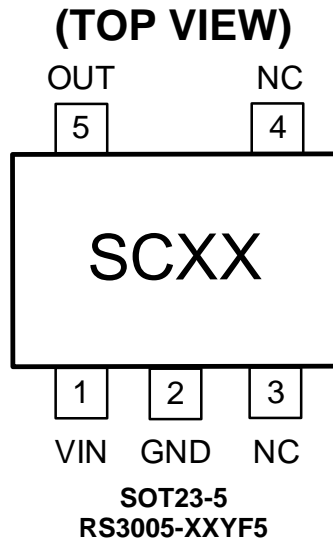
Pin Configuration and Functions (Top View)

SOT23-5 RS3005-XXYF5		I/O	FUNCTION
NUMBER	NAME		
1	VIN	I	Regulator Input. Up to 36V input voltage. At least 1μF supply bypass capacitor is recommended.
2	GND	G	Ground.
3	NC	-	Not connect
4	NC	-	Not connect
5	OUT	O	Regulator Output. Recommended output capacitor range:1μF to 10μF.

SOT23-5 RS3005-XXSYF5		I/O	FUNCTION
NUMBER	NAME		
1	VIN	I	Regulator Input. Up to 36V input voltage. At least 1μF supply bypass capacitor is recommended.
2	GND	G	Ground.
3	EN	I	Enable pin. Drive EN greater than $V_{EN(H)}$ to turn on the regulator. Drive EN less than $V_{EN(L)}$ to put the LDO into shutdown mode.
4	NC	-	Not connect
5	OUT	O	Regulator Output. Recommended output capacitor range:1μF to 10μF.

Pin Configuration and Functions (Top View) (TOP VIEW)

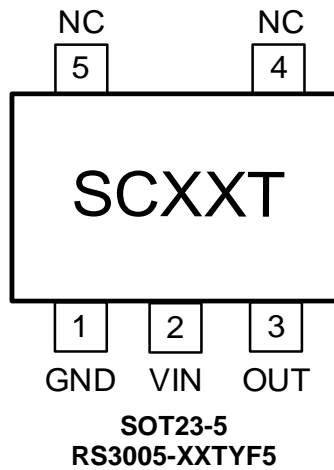

SOT23-5 RS3005-XXTYF5		I/O	FUNCTION
NUMBER	NAME		
1	GND	G	Ground.
2	VIN	I	Regulator Input. Up to 36V input voltage. At least 1μF supply bypass capacitor is recommended.
3	OUT	O	Regulator Output. Recommended output capacitor range:1μF to 10μF.
4	NC	-	Not connect
5	NC	-	Not connect

PACKAGE/ORDERING INFORMATION

PRODUCT	ORDERING NUMBER	V _{out} (V)	PACKAGE LEAD	PACKAGE MARKING ^(1/2)	PACKAGE OPTION
RS3005-3.0	RS3005-3.0YF3	3.0	SOT23-3	SC30	Tape and Reel,3000
	RS3005-3.0YF5	3.0	SOT23-5	SC30	Tape and Reel,3000
	RS3005-3.0SYF5	3.0	SOT23-5	SC30S	Tape and Reel,3000
	RS3005-3.0YSF3	3.0	SOT23	C30XX	Tape and Reel,3000
	RS3005-3.0YE3	3.0	SOT89-3L	SC30	Tape and Reel,1000
	RS3005-3.0YE3L	3.0	SOT89-3L (L-Type)	SC30L	Tape and Reel,1000
RS3005-3.3	RS3005-3.3YF3	3.3	SOT23-3	SC33	Tape and Reel,3000
	RS3005-3.3YF5	3.3	SOT23-5	SC33	Tape and Reel,3000
	RS3005-3.3SYF5	3.3	SOT23-5	SC33S	Tape and Reel,3000
	RS3005-3.3TYF5	3.3	SOT23-5	SC33T	Tape and Reel,3000
	RS3005-3.3YSF3	3.3	SOT23	C33XX	Tape and Reel,3000
	RS3005-3.3YE3	3.3	SOT89-3L	SC33	Tape and Reel,1000
	RS3005-3.3YE3L	3.3	SOT89-3L (L-Type)	SC33L	Tape and Reel,1000
RS3005-3.6	RS3005-3.6YF3	3.6	SOT23-3	SC36	Tape and Reel,3000
	RS3005-3.6YF5	3.6	SOT23-5	SC36	Tape and Reel,3000
	RS3005-3.6SYF5	3.6	SOT23-5	SC36S	Tape and Reel,3000
	RS3005-3.6YSF3	3.6	SOT23	C36XX	Tape and Reel,3000
	RS3005-3.6YE3	3.6	SOT89-3L	SC36	Tape and Reel,1000
	RS3005-3.6YE3L	3.6	SOT89-3L (L-Type)	SC36L	Tape and Reel,1000
RS3005-5.0	RS3005-5.0YF3	5.0	SOT23-3	SC50	Tape and Reel,3000
	RS3005-5.0YF5	5.0	SOT23-5	SC50	Tape and Reel,3000
	RS3005-5.0SYF5	5.0	SOT23-5	SC50S	Tape and Reel,3000
	RS3005-5.0TYF5	5.0	SOT23-5	SC50T	Tape and Reel,3000
	RS3005-5.0YSF3	5.0	SOT23	C50XX	Tape and Reel,3000
	RS3005-5.0YE3	5.0	SOT89-3L	SC50	Tape and Reel,1000
	RS3005-5.0YE3L	5.0	SOT89-3L (L-Type)	SC50L	Tape and Reel,1000
	RS3005-5.0YT3	5.0	TO-92	SC50	Tape and Reel,2000
RS3005-4.36	RS3005-4.36YSF3	4.36	SOT23	C436XX	Tape and Reel,3000
RS3005-9.0	RS3005-9.0YE3	9.0	SOT89-3L	SC90	Tape and Reel,1000
	RS3005-9.0YE3L	9.0	SOT89-3L (L-Type)	SC90L	Tape and Reel,1000
RS3005-12.0	RS3005-12.0YE3	12.0	SOT89-3L	SCC0	Tape and Reel,1000
	RS3005-12.0YE3L	12.0	SOT89-3L (L-Type)	SCC0L	Tape and Reel,1000

NOTE:

- (1) There may be additional marking, which relates to the lot trace code information(data code and vendor code), the logo or the environmental category on the device.
- (2) XX = Date Code and Vendor Code.

Specifications

Absolute Maximum Ratings

over operating free-air temperature range (unless otherwise noted) ⁽¹⁾⁽²⁾

		MIN	MAX	UNIT
V _{IN}	Input voltage	-0.3	40	V
V _{EN}	Enable input voltage	-0.3	V _{IN}	V
T _J	Junction temperature	-40	150	°C
P _D	Continuous power dissipation ⁽³⁾	Internally Limited		W
T _{stg}	Storage temperature	-65	150	°C

(1) Stresses beyond those listed under *Absolute Maximum Ratings* may cause permanent damage to the device. These are stress ratings only, and functional operation of the device at these or any other conditions beyond those indicated under *Recommended Operating Conditions* is not implied. Exposure to absolute-maximum-rated conditions for extended periods may affect device reliability.

(2) All voltages are with respect to the GND pin.

(3) Internal thermal shutdown circuitry protects the device from permanent damage.

ESD Ratings

		VALUE	UNIT	
V _(ESD)	Electrostatic discharge	Human-body model (HBM)	±1000	V
		Machine model (MM)	±100	V

Recommended Operating Conditions

over operating free-air temperature range (unless otherwise noted) ⁽¹⁾

		MIN	MAX	UNIT
V _{IN}	Input supply voltage	2.5	36	V
V _{EN}	Enable voltage	0	36	V
I _{OUT}	Output current	0	150	mA
T _A	Operating temperature	-40	+85	°C

(1) All voltages are with respect to the GND pin.

Thermal Information

THERMAL METRIC (1)		RS3005	RS3005	RS3005	RS3005	UNIT
		SOT23/ SOT23-3/ SOT23-5	SOT89-3L	SOT89-3L (L-Type)	TO-92	
		3 PINS/ 5 PINS	3 PINS	3 PINS	3 PINS	
R _{θJA}	Junction-to-ambient thermal resistance	185.6	75	165	143.6	°C/W
R _{θJC(top)}	Junction-to-case (top) thermal resistance	104.3	88.1	88.5	74.4	°C/W
R _{θJB}	Junction-to-board thermal resistance	54.5	9.6	39.6	—	°C/W
ψ _{JT}	Junction-to-top characterization parameter	31.0	6.2	26.5	24.2	°C/W
ψ _{JB}	Junction-to-board characterization parameter	54.5	9.7	49.7	120.9	°C/W
R _{JC(bot)}	Junction-to-case (bottom) thermal resistance	N/A	7.7	77.7	—	°C/W

ELECTRICAL CHARACTERISTICS

($V_{IN} = V_{OUT} + 2V$, $C_{IN} = C_{OUT} = 1\mu F$, $V_{OUT} = 3.3V$, Full = $-40^{\circ}C$ to $+85^{\circ}C$, typical values are at $T_A = +25^{\circ}C$, unless otherwise noted.)

PARAMETER	SYMBOL	CONDITIONS	TEMP	MIN	TYP	MAX	UNITS
Input Voltage	V_{IN}	$V_{OUT} = 3.3V$	$+25^{\circ}C$	2.5 ⁽¹⁾		36	V
Output Voltage Accuracy		$I_{OUT} = 1mA$	$+25^{\circ}C$	-2.5	0	2.5	%
Ground Pin Current		No load	$+25^{\circ}C$		11	18	μA
					$V_{IN} = V_{OUT} + 2V$	16	
		$V_{IN} = 36V$		11			
		$I_{OUT} = 50mA$			11		
Maximum Output Current ⁽²⁾			$+25^{\circ}C$	150			mA
Dropout Voltage ⁽³⁾	V_{DROP}	$I_{OUT} = 150mA$	$+25^{\circ}C$		1300	1800	mV
Line Regulation	$\frac{\Delta V_{OUT}}{\Delta V_{IN} \times V_{OUT}}$	$V_{IN} = V_{OUT} + 2V$ to $36V$, $I_{OUT} = 1mA$	$+25^{\circ}C$		0.005	0.012	%/V
Load Regulation	ΔV_{OUT}	$V_{IN} = V_{OUT} + 2V$, $I_{OUT} = 1mA$ to $150mA$	$+25^{\circ}C$		10	25	mV
Power Supply Rejection Ratio	PSRR	$V_{OUT} = 3.3V$, $I_{OUT} = 10mA$	$+25^{\circ}C$		65		dB
					$f = 217Hz$		
Output Voltage Temperature Coefficient ⁽⁴⁾	$\frac{\Delta V_{OUT}}{\Delta T_A \times V_{OUT}}$	$I_{OUT} = 1mA$	FULL		70		ppm/ $^{\circ}C$
					$f = 1KHz$		
THERMAL PROTECTION							
Thermal Shutdown Temperature	T_{SHDN}				150		$^{\circ}C$
SHUTDOWN							
EN Voltage Range	V_{EN}		FULL	-0.3		$V_{IN} + 0.3$	V
EN Input Threshold	V_{IH}	$V_{IN} = V_{OUT} + 2V$ to $36V$	FULL	1.1			V
	V_{IL}	$V_{IN} = V_{OUT} + 2V$ to $36V$	FULL			0.4	
EN Input Bias Current	I_{BH}	EN=36V	$+25^{\circ}C$		0.01	1	μA
	I_{BL}	EN=0V	FULL		0.01	1	
Shutdown Supply Current	$I_{Q(SHDN)}$	EN=0V	FULL		1.5	3	μA
Start-Up Time ⁽⁵⁾	t_{STR}	$C_{OUT} = 1\mu F$, No Load	$+25^{\circ}C$		230		μs

NOTES:

- $V_{IN} = V_{OUT}$ (NOMINAL) or 2.5V, whichever is greater.
- Maximum output current is affected by the PCB layout, size of metal trace, the thermal conduction path between metal layers, ambient temperature and the other environment factors of system. Attention should be paid to the dropout voltage when $V_{IN} < V_{OUT} + V_{DROP}$.
- The dropout voltage is defined as $V_{IN} - V_{OUT}$, when V_{OUT} is 100mV below the value of V_{OUT} for $V_{IN} = V_{OUT}$ (NOMINAL) + 2V.
- Output voltage temperature coefficient is defined as the worst-case voltage change divided by the total temperature range.
- Time needed for V_{OUT} to reach 90% of final value.

ELECTRICAL CHARACTERISTICS

($V_{IN} = V_{OUT} + 2V$, $C_{IN} = C_{OUT} = 1\mu F$, $V_{OUT} = 5.0V$, Full = $-40^{\circ}C$ to $+85^{\circ}C$, typical values are at $T_A = +25^{\circ}C$, unless otherwise noted.)

PARAMETER	SYMBOL	CONDITIONS	TEMP	MIN	TYP	MAX	UNITS	
Input Voltage	V_{IN}	$V_{OUT} = 5.0V$	$+25^{\circ}C$	2.5 ⁽¹⁾		36	V	
Output Voltage Accuracy		$I_{OUT} = 1mA$	$+25^{\circ}C$	-2.5	0	2.5	%	
Ground Pin Current		No load	$+25^{\circ}C$	$V_{IN} = V_{OUT} + 2V$		11	18	μA
				$V_{IN} = 36V$		16	25	
		$I_{OUT} = 50mA$		11				
Maximum Output Current ⁽²⁾			$+25^{\circ}C$	150			mA	
Dropout Voltage ⁽³⁾	V_{DROP}	$I_{OUT} = 150mA$	$+25^{\circ}C$		1100	1600	mV	
Line Regulation	$\frac{\Delta V_{OUT}}{\Delta V_{IN} \times V_{OUT}}$	$V_{IN} = V_{OUT} + 2V$ to $36V$, $I_{OUT} = 1mA$	$+25^{\circ}C$		0.005	0.012	%/V	
Load Regulation	ΔV_{OUT}	$V_{IN} = V_{OUT} + 2V$, $I_{OUT} = 1mA$ to $150mA$	$+25^{\circ}C$		10	25	mV	
Power Supply Rejection Ratio	PSRR	$V_{OUT} = 5.0V$, $I_{OUT} = 10mA$	$+25^{\circ}C$	$f = 217Hz$		65	dB	
				$f = 1KHz$		63		
Output Voltage Temperature Coefficient ⁽⁴⁾	$\frac{\Delta V_{OUT}}{\Delta T_A \times V_{OUT}}$	$I_{OUT} = 1mA$	FULL		70		ppm/ $^{\circ}C$	
THERMAL PROTECTION								
Thermal Shutdown Temperature	T_{SHDN}				150		$^{\circ}C$	
SHUTDOWN								
EN Voltage Range	V_{EN}		FULL	-0.3		$V_{IN} + 0.3$	V	
EN Input Threshold	V_{IH}	$V_{IN} = V_{OUT} + 2V$ to $36V$	FULL	1.1			V	
	V_{IL}	$V_{IN} = V_{OUT} + 2V$ to $36V$	FULL			0.4		
EN Input Bias Current	I_{BH}	EN=36V	$+25^{\circ}C$		0.01	1	μA	
	I_{BL}	EN=0V	FULL		0.01	1		
Shutdown Supply Current	$I_{Q(SHDN)}$	EN=0V	FULL		1.5	3	μA	
Start-Up Time ⁽⁵⁾	t_{STR}	$C_{OUT} = 1\mu F$, No Load	$+25^{\circ}C$		230		μs	

NOTES:

- $V_{IN} = V_{OUT}$ (NOMINAL) or 2.5V, whichever is greater.
- Maximum output current is affected by the PCB layout, size of metal trace, the thermal conduction path between metal layers, ambient temperature and the other environment factors of system. Attention should be paid to the dropout voltage when $V_{IN} < V_{OUT} + V_{DROP}$.
- The dropout voltage is defined as $V_{IN} - V_{OUT}$, when V_{OUT} is 100mV below the value of V_{OUT} for $V_{IN} = V_{OUT}$ (NOMINAL) + 2V.
- Output voltage temperature coefficient is defined as the worst-case voltage change divided by the total temperature range.
- Time needed for V_{OUT} to reach 90% of final value.

TYPICAL CHARACTERISTICS

$V_{IN} = 5.3V$, $V_{OUT} = 3.3V$, $C_{IN} = C_{OUT} = 1\mu F$, $T_A = 25^\circ C$ unless otherwise noted.

Line-Transient Response

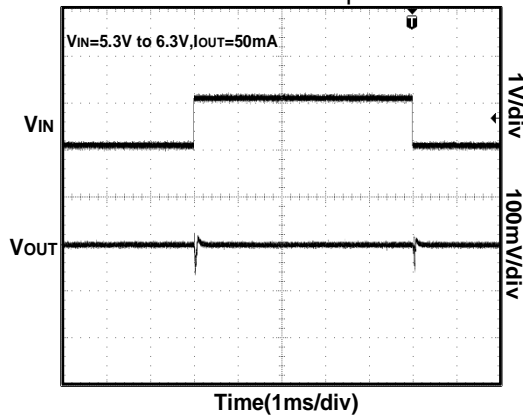

Load-Transient Response

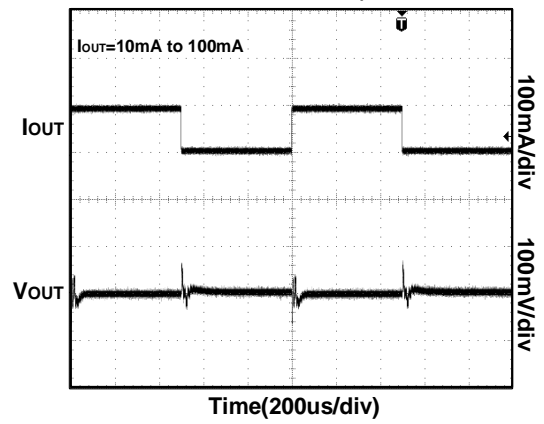

Power-Up/Power-Down Output Waveform

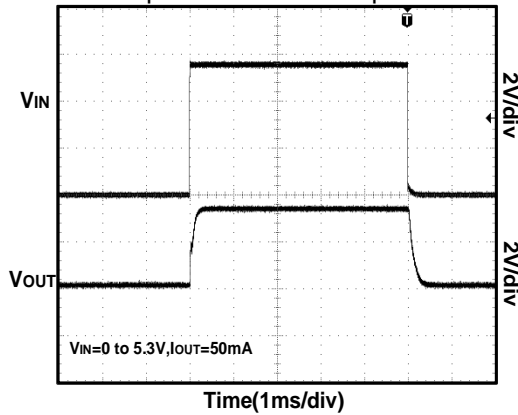

Output Short Waveform

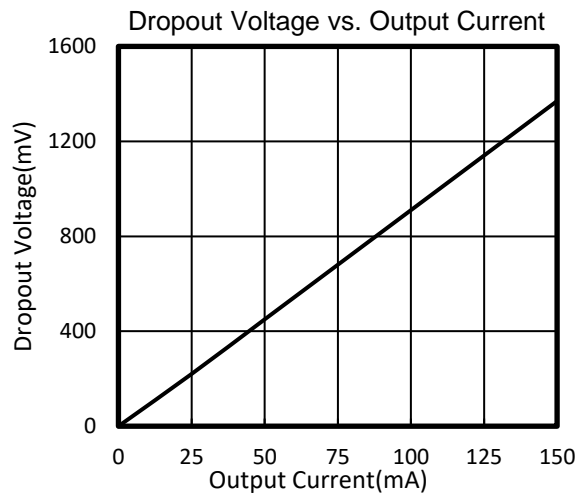
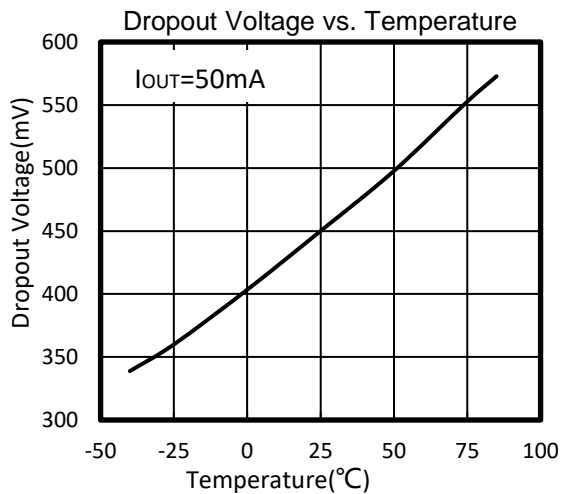
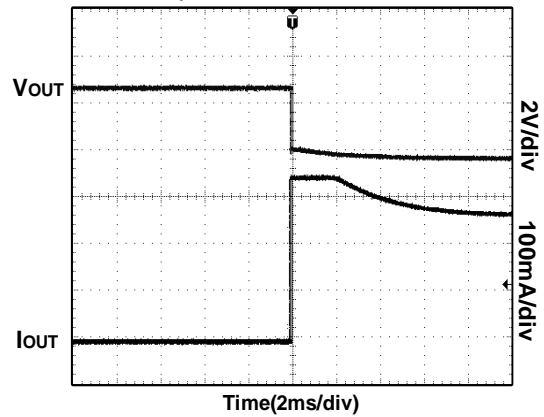

TYPICAL CHARACTERISTICS

$V_{IN} = 5.3V$, $V_{OUT} = 3.3V$, $C_{IN} = C_{OUT} = 1\mu F$, $T_A = 25^\circ C$ unless otherwise noted.

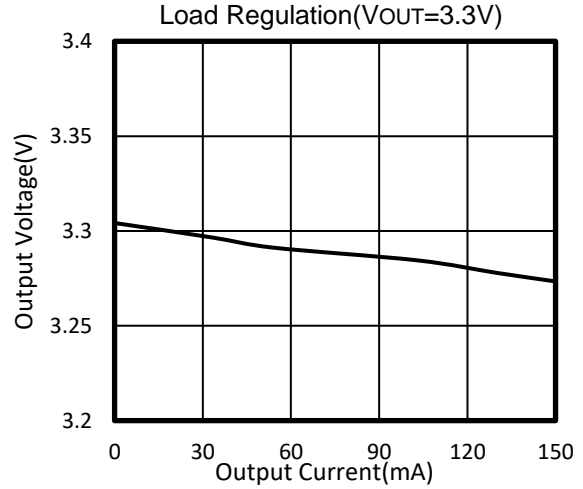
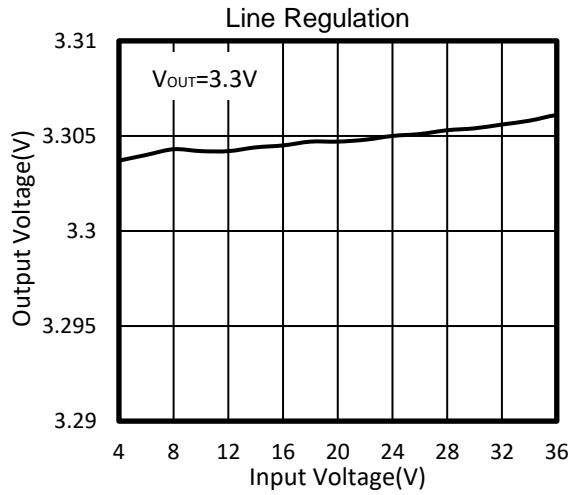
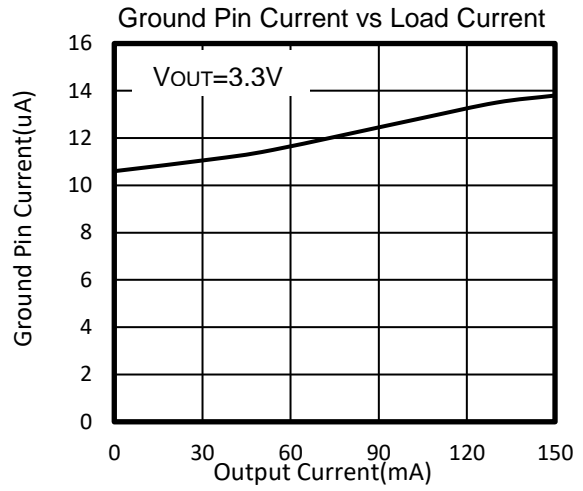
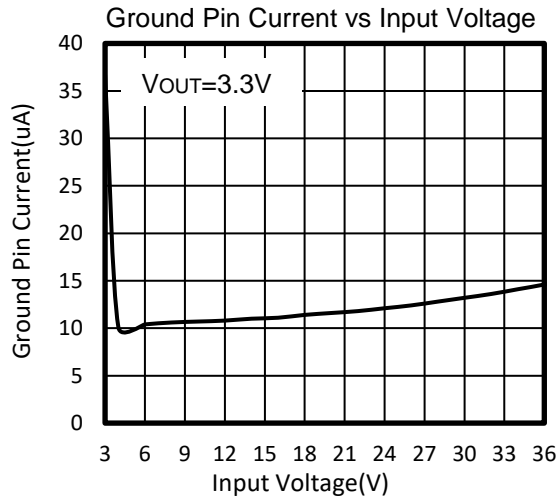

DETAILED DESCRIPTION

Overview

The RS3005 low-dropout regulators (LDO) consumes only 11 μ A of quiescent current at light load and delivers excellent line and load transient performance. These characteristics, combined with low noise and good PSRR with low dropout voltage, make this device ideal for portable consumer applications.

Functional Block Diagram

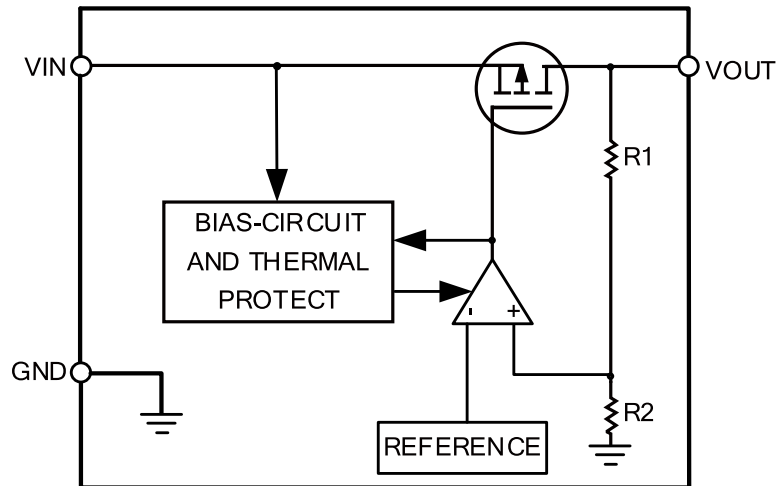

Thermal Considerations

When the junction temperature is too high, the thermal protection circuitry sends a signal to the control logic that will shut down the IC. The IC will restart when the temperature has sufficiently cooled down. The maximum power dissipation is dependent on the thermal resistance of the case and the circuit board, the temperature difference between the die junction and the ambient air, and the rate of air flow. The GND pin must be connected to the ground plane for proper dissipation.

Operation with V_{IN} Lower Than 2.5V

The device normally operates with input voltages above 2.5V. At input voltages below the 2.5V, the device does not operate.

Operation with V_{IN} Larger Than 2.5V

When V_{IN} is greater than 2.5V, if V_{IN} is also higher than the output set value plus the device dropout voltage, V_{OUT} is equal to the set value. Otherwise, V_{OUT} is equal to V_{IN} minus the dropout voltage.

PACKAGE OUTLINE DIMENSIONS

SOT23-3

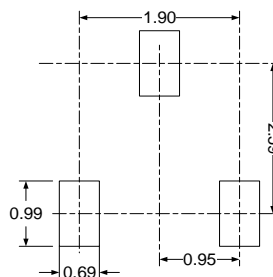
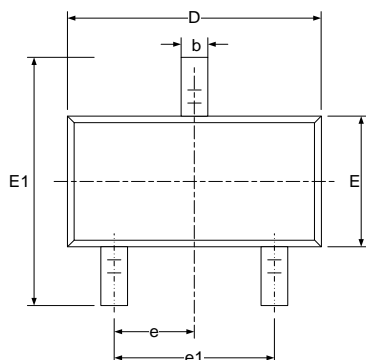
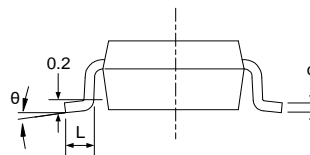
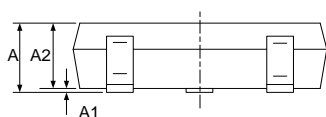
RECOMMENDED LAND PATTERN (Unit: mm)

Symbol	Dimensions In Millimeters		Dimensions In Inches	
	Min	Max	Min	Max
A	1.050	1.250	0.041	0.049
A1	0.000	0.100	0.000	0.004
A2	1.050	1.150	0.041	0.045
b	0.300	0.500	0.012	0.020
c	0.100	0.200	0.004	0.008
D	2.820	3.020	0.111	0.119
E	1.500	1.700	0.059	0.067
E1	2.650	2.950	0.104	0.116
e	0.950(BSC)		0.037(BSC)	
e1	1.800	2.000	0.071	0.079
L	0.300	0.600	0.012	0.024
θ	0°	8°	0°	8°

SOT23

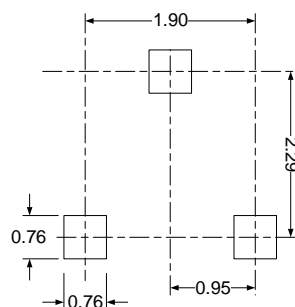
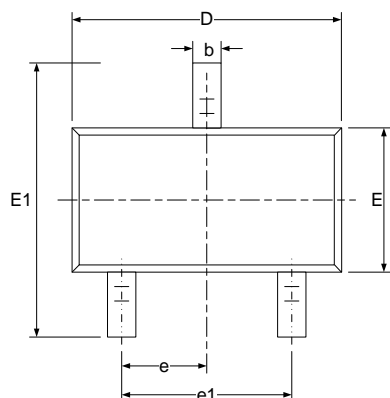
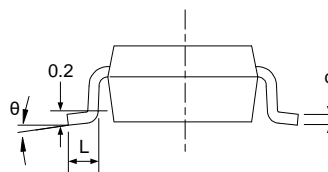
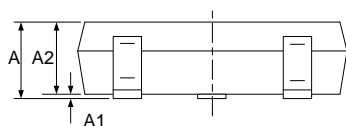
RECOMMENDED LAND PATTERN (Unit: mm)

Symbol	Dimensions In Millimeters		Dimensions In Inches	
	Min	Max	Min	Max
A	0.900	1.150	0.035	0.045
A1	0.000	0.100	0.000	0.004
A2	0.900	1.050	0.035	0.041
b	0.300	0.500	0.012	0.020
c	0.080	0.150	0.003	0.006
D	2.800	3.000	0.110	0.118
E	1.200	1.400	0.047	0.055
E1	2.250	2.550	0.089	0.100
e	0.950(BSC)		0.037(BSC)	
e1	1.800	2.000	0.071	0.079
L	0.300	0.500	0.012	0.020
θ	0°	8°	0°	8°

SOT23-5

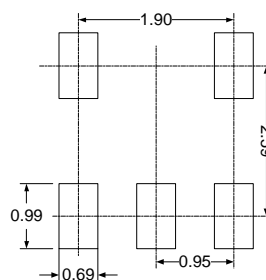
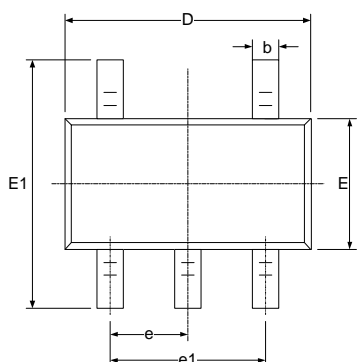
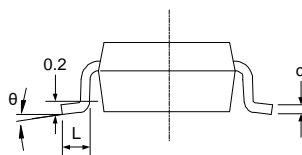
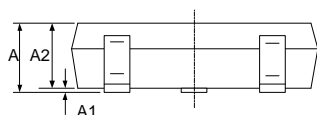
RECOMMENDED LAND PATTERN (Unit: mm)

Symbol	Dimensions In Millimeters		Dimensions In Inches	
	Min	Max	Min	Max
A	1.050	1.250	0.041	0.049
A1	0.000	0.100	0.000	0.004
A2	1.050	1.150	0.041	0.045
b	0.300	0.500	0.012	0.020
c	0.100	0.200	0.004	0.008
D	2.820	3.020	0.111	0.119
E	1.500	1.700	0.059	0.067
E1	2.650	2.950	0.104	0.116
e	0.950(BSC)		0.037(BSC)	
e1	1.800	2.000	0.071	0.079
L	0.300	0.600	0.012	0.024
θ	0°	8°	0°	8°

SOT89-3L

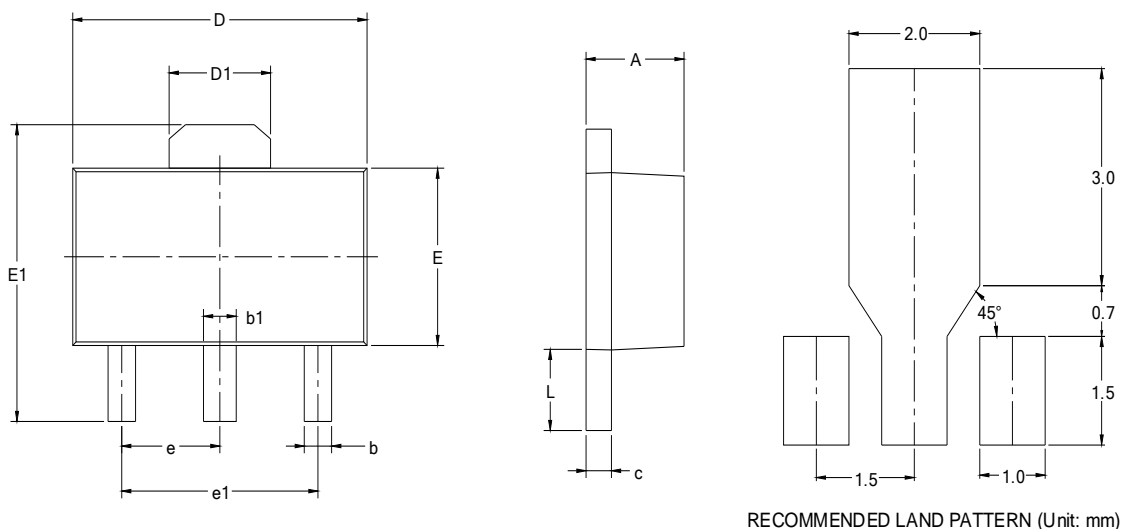

Symbol	Dimensions In Millimeters		Dimensions In Inches	
	Min	Max	Min	Max
A	1.400	1.600	0.055	0.063
b	0.320	0.520	0.013	0.020
b1	0.400	0.580	0.016	0.023
c	0.350	0.440	0.014	0.017
D	4.400	4.600	0.173	0.181
D1	1.550 REF		0.061 REF	
E	2.300	2.600	0.091	0.102
E1	3.940	4.250	0.155	0.167
e	1.500 BSC		0.060 BSC	
e1	3.000 BSC		0.118 BSC	
L	0.900	1.200	0.035	0.047

TO-92

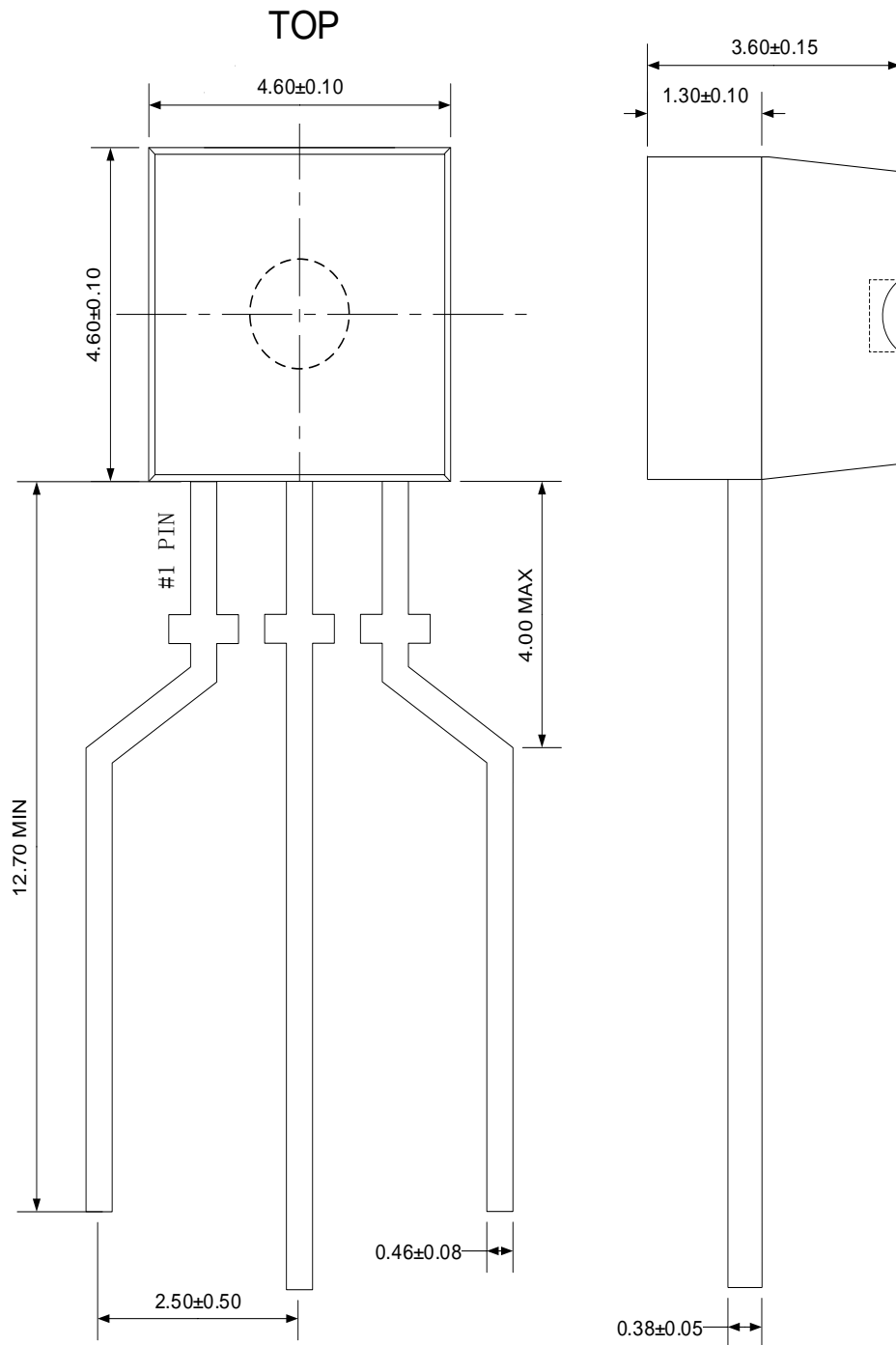

RECOMMENDED LAND PATTERN (Unit: mm)

单击下面可查看定价，库存，交付和生命周期等信息

>>润石