

# 1MHz, Precision, Rail-to-Rail I/O CMOS Operational Amplifier

## FEATURES

- **HIGH GAIN BANDWIDTH: 1MHz**
- **RAIL-TO-RAIL INPUT AND OUTPUT**  
**±4.5mV Max Vos**
- **INPUT VOLTAGE RANGE: -0.1V to +5.6V**  
**with Vs = 5.5V**
- **SUPPLY RANGE: +2.5V to +5.5V**
- **SPECIFIED UP TO +125°C**
- **Micro SIZE PACKAGES: SOT353(SC70-5)**

## APPLICATIONS

- **SENSORS**
- **PHOTODIODE AMPLIFICATION**
- **ACTIVE FILTERS**
- **TEST EQUIPMENT**
- **DRIVING A/D CONVERTERS**

## DESCRIPTION

The RS321BK products offer low voltage operation and rail-to-rail input and output, as well as excellent speed/power consumption ratio, providing an excellent bandwidth (1MHz) and slew rate of 0.45V/us. The op-amps are unity gain stable and feature an ultra-low input bias current.

The RS321BK has lower offset, which is guaranteed not upper than ±4.5mV at 25°C with Vs = 5V, V<sub>CM</sub> = Vs/2.

The devices are ideal for sensor interfaces, active filters and portable applications. The RS321BK families of operational amplifiers are specified at the full temperature range of -40°C to +125°C under single or dual power supplies of 2.5V to 5.5V.

### Device Information <sup>(1)</sup>

PART NUMBER	PACKAGE	BODY SIZE(NOM)
RS321BK	SOT23-5	2.90mm × 1.60mm
	SOT353(SC70-5)	2.10mm × 1.25mm

(1) For all available packages, see the orderable addendum at the end of the data sheet.

## Pin Configuration and Functions (Top View)

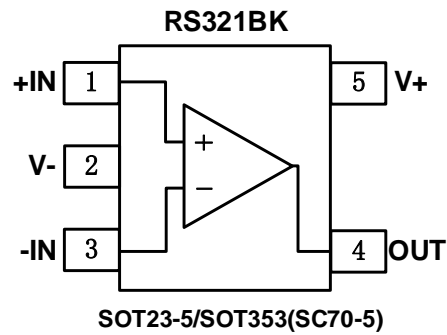

### Pin Description

NAME	PIN		I/O	DESCRIPTION
	RS321BK			
	SOT23-5/ SOT353(SC70-5)			
+IN	1		I	Positive (noninverting) input
V-	2		-	Negative (lowest) power supply
-IN	3		I	Negative (inverting) input
OUT	4		O	Output
V+	5		-	Positive (highest) power supply

## SPECIFICATIONS

### Absolute Maximum Ratings

Over operating free-air temperature range (unless otherwise noted) <sup>(1)</sup>

		MIN	MAX	UNIT
Voltage	Supply, $V_s=(V+) - (V-)$		7	V
	Signal input pin <sup>(2)</sup>	(V-)-0.5	(V+) +0.5	
	Signal output pin <sup>(3)</sup>	(V-)-0.5	(V+) +0.5	
Current	Signal input pin <sup>(2)</sup>	-10	10	mA
	Signal output pin <sup>(3)</sup>	-140	140	mA
	Output short-circuit <sup>(4)</sup>	Continuous		
Temperature	Operating range, $T_A$	-40	125	°C
	Junction, $T_J$		150	
	Storage, $T_{stg}$	-65	150	

(1) Stresses above these ratings may cause permanent damage. Exposure to absolute maximum conditions for extended periods may degrade device reliability. These are stress ratings only, and functional operation of the device at these or any other conditions beyond those specified is not implied.

(2) Input terminals are diode-clamped to the power-supply rails. Input signals that can swing more than 0.5V beyond the supply rails should be current-limited to 10mA or less.

(3) Output terminals are diode-clamped to the power-supply rails. Output signals that can swing more than 0.5V beyond the supply rails should be current-limited to  $\pm 140$ mA or less.

(4) Short-circuit to ground, one amplifier per package.

### ESD Ratings

			VALUE	UNIT
$V_{(ESD)}$	Electrostatic discharge	Human-body model (HBM)	$\pm 3000$	V
		Machine Model (MM)	$\pm 200$	

### Recommended Operating Conditions

Over operating free-air temperature range (unless otherwise noted)

		MIN	NOM	MAX	UNIT
Supply voltage, $V_s= (V+) - (V-)$	Single-supply	2.5		5.5	V
	Dual-supply	$\pm 1.25$		$\pm 2.75$	

### Thermal Information:RS321BK

THERMAL METRIC <sup>(1)</sup>		RS321BK		UNIT
		5PINS		
		SOT23-5	SOT353(SC70-5)	
$R_{\theta JA}$	Junction-to-ambient thermal resistance	273.8	214.7	°C/W
$R_{\theta JC(top)}$	Junction-to-case(top) thermal resistance	126.8	127.1	°C/W
$R_{\theta JB}$	Junction-to-board thermal resistance	85.9	60.0	°C/W
$\Psi_{JT}$	Junction-to-top characterization parameter	10.9	33.4	°C/W
$\Psi_{JB}$	Junction-to-board characterization parameter	84.9	59.8	°C/W
$R_{\theta JC(bot)}$	Junction-to-case(bottom) thermal resistance	N/A	N/A	°C/W

**PACKAGE/ORDERING INFORMATION**

Orderable Device	Package Type	Pin	Channel	Op Temp(°C)	Device Marking <sup>(1)</sup>	Package Qty
RS321BKXF	SOT23-5	5	1	-40°C~125°C	321BK	Tape and Reel,3000
RS321BKXC5	SOT353(SC70-5)	5	1	-40°C~125°C	321BK	Tape and Reel,3000

## NOTE:

- (1) There may be additional marking, which relates to the lot trace code information(data code and vendor code), the logo or the environmental category on the device.

## ELECTRICAL CHARACTERISTICS

(At  $T_A = +25^\circ\text{C}$ ,  $V_S = 5\text{V}$ ,  $R_L = 10\text{k}\Omega$  connected to  $V_S/2$ , and  $V_{OUT} = V_S/2$ , unless otherwise noted.)

PARAMETER		CONDITIONS	$T_J$	RS321BK			UNITS
				MIN	TYP	MAX	
<b>POWER SUPPLY</b>							
$V_S$	Operating Voltage Range		$25^\circ\text{C}$	2.5		5.5	V
$I_Q$	Quiescent Current/Amplifier		$25^\circ\text{C}$		85	140	$\mu\text{A}$
PSRR	Power-Supply Rejection Ratio	$V_S = 2.5\text{V to } 5.5\text{V}$ , $V_{CM} = (V_-) + 0.5\text{V}$	$25^\circ\text{C}$	70	75		dB
			$-40^\circ\text{C to } 125^\circ\text{C}$	64			
<b>INPUT</b>							
$V_{OS}$	Input Offset Voltage	$V_{CM} = 0\text{V to } 3.5\text{V}$	$25^\circ\text{C}$	-4.5	$\pm 0.8$	4.5	mV
$V_{OS\ TC}$	Input Offset Voltage Average Drift	$-40^\circ\text{C to } 125^\circ\text{C}$			2		$\mu\text{V}/^\circ\text{C}$
$I_B$	Input Bias Current		$25^\circ\text{C}$		10		pA
$I_{OS}$	Input Offset Current		$25^\circ\text{C}$		10		pA
$V_{CM}$	Common-Mode Voltage Range	$V_S = 5.5\text{V}$	$25^\circ\text{C}$	-0.1		5.6	V
CMRR	Common-Mode Rejection Ratio	$V_S = 5.5\text{V}$ , $V_{CM} = -0.1\text{V to } 4\text{V}$	$25^\circ\text{C}$	65	85		dB
			$-40^\circ\text{C to } 125^\circ\text{C}$	62			
			$25^\circ\text{C}$	58	80		
			$-40^\circ\text{C to } 125^\circ\text{C}$	56			
<b>OUTPUT</b>							
$A_{OL}$	Open-Loop Voltage Gain	$R_L = 2\text{k}\Omega$ , $V_O = 0.15\text{V to } 4.85\text{V}$	$25^\circ\text{C}$	85	95		dB
			$-40^\circ\text{C to } 125^\circ\text{C}$	75			
			$25^\circ\text{C}$	88	100		
			$-40^\circ\text{C to } 125^\circ\text{C}$	80			
	Output Swing From Rail	$R_L = 2\text{k}\Omega$	$25^\circ\text{C}$		25		mV
		$R_L = 10\text{k}\Omega$			8		
$I_{OUT}$	Output Current Source		$25^\circ\text{C}$		120		mA
<b>FREQUENCY RESPONSE</b>							
SR	Slew Rate		$25^\circ\text{C}$		0.45		V/ $\mu\text{s}$
GBP	Gain-Bandwidth Product		$25^\circ\text{C}$		1		MHz
PM	Phase Margin		$25^\circ\text{C}$		64		$^\circ$
$t_S$	Setting Time, 0.1%				1.3		$\mu\text{s}$
	Overload Recovery Time	$V_{IN} \cdot \text{Gain} \geq V_S$			2.3		$\mu\text{s}$
<b>NOISE</b>							
$e_n$	Input Voltage Noise Density	$f = 1\text{KHz}$	$25^\circ\text{C}$		22		$\text{nV}/\sqrt{\text{Hz}}$
		$f = 10\text{KHz}$	$25^\circ\text{C}$		20		$\text{nV}/\sqrt{\text{Hz}}$

## TYPICAL CHARACTERISTICS

At  $T_A = +25^\circ\text{C}$ ,  $V_S = 5\text{V}$ ,  $R_L = 10\text{k}\Omega$  connected to  $V_S/2$ ,  $V_{OUT} = V_S/2$ , unless otherwise noted.

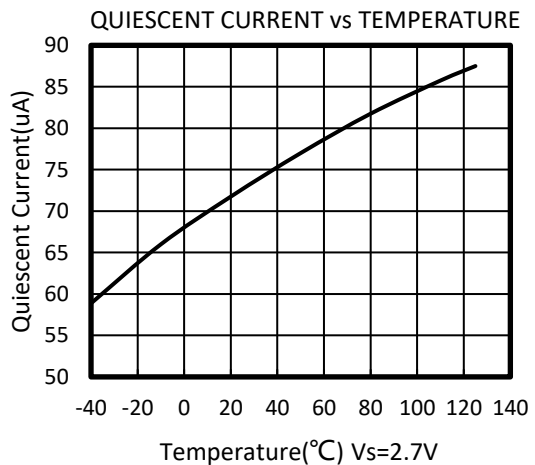
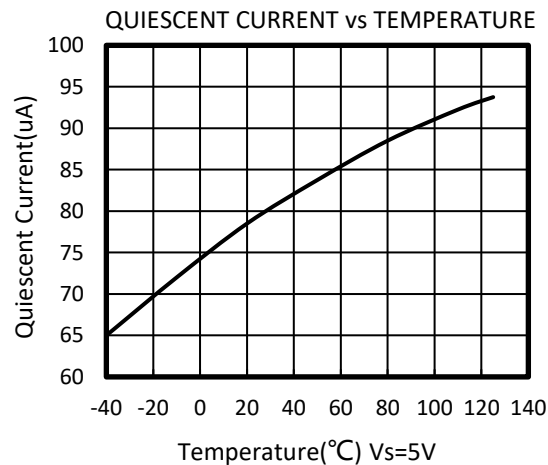
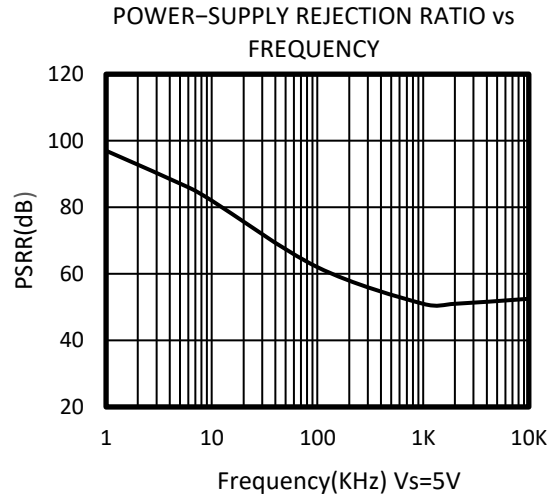
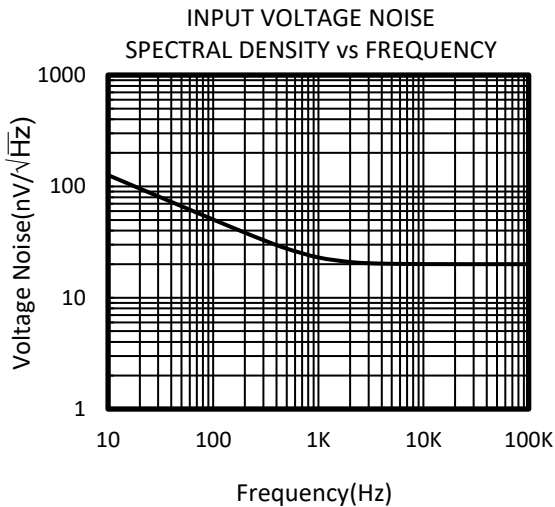
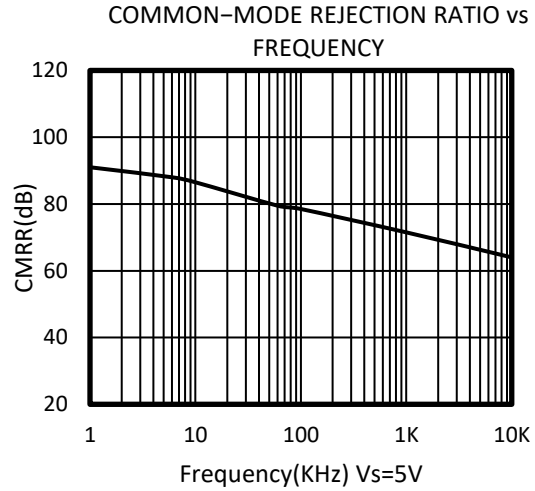
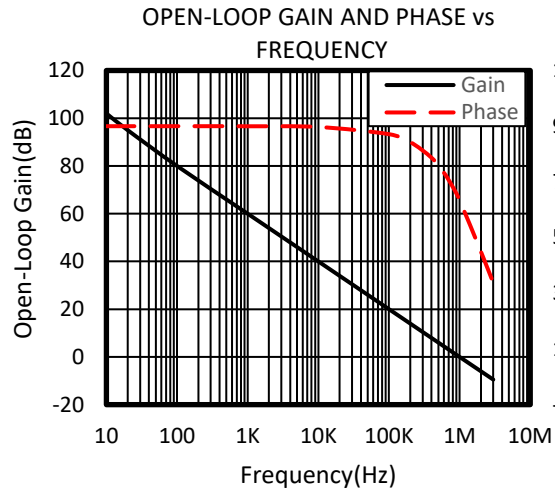

## TYPICAL CHARACTERISTICS

At  $T_A = +25^\circ\text{C}$ ,  $V_S = 5\text{V}$ ,  $R_L = 10\text{k}\Omega$  connected to  $V_S/2$ ,  $V_{OUT} = V_S/2$ , unless otherwise noted.

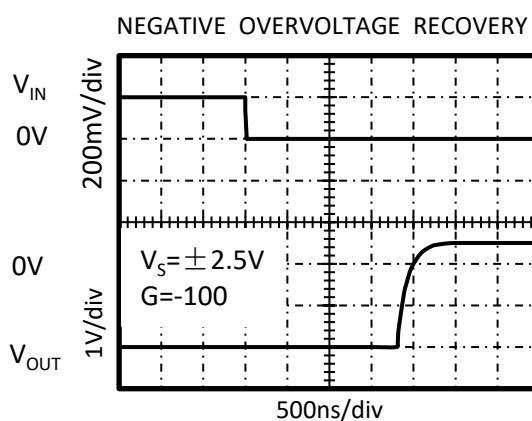
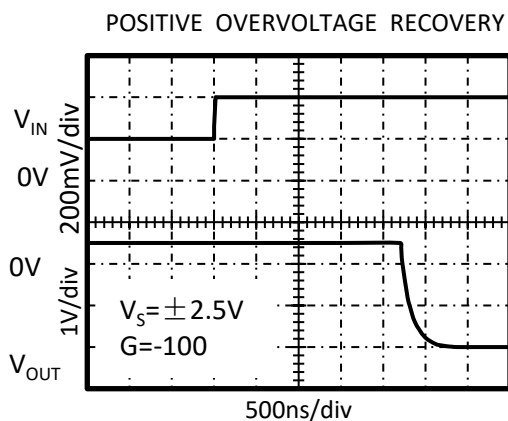
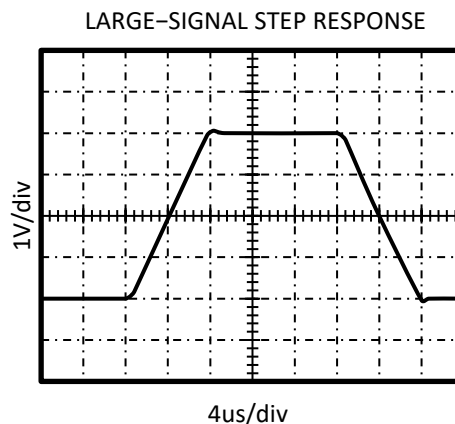
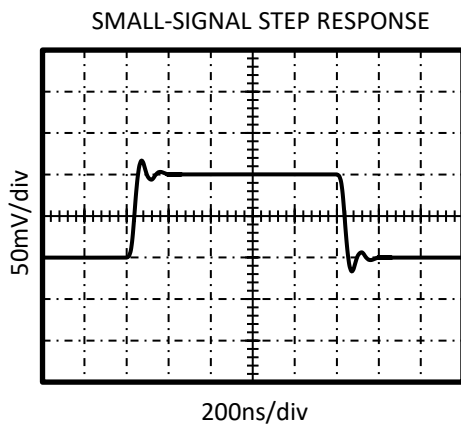
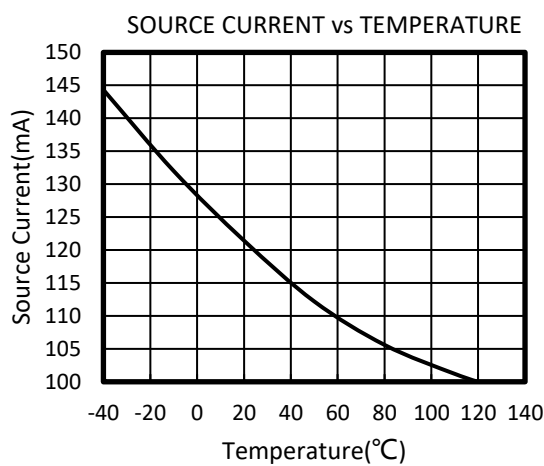
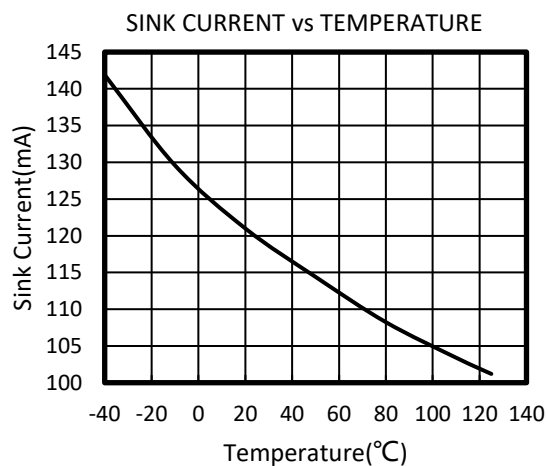

## APPLICATION NOTES

The RS321BK is high precision, rail-to-rail operational amplifiers that can be run from a single-supply voltage 2.5V to 5.5V ( $\pm 1.25V$  to  $\pm 2.75V$ ). Supply voltages higher than 7V (absolute maximum) can permanently damage the amplifier.

Rail-to-rail input and output swing significantly increases dynamic range, especially in low-supply applications.

Good layout practice mandates use of a 0.1uF capacitor place closely across the supply pins.

## LAYOUT GUIDELINS

Attention to good layout practices is always recommended. Keep traces short. When possible, use a PCB ground plane with surface-mount components placed as close to the device pins as possible. Place a 0.1uF capacitor closely across the supply pins.

These guidelines should be applied throughout the analog circuit to improve performance and provide benefits such as reducing the EMI susceptibility.

## INSTRUMENTATION AMPLIFIER

In the three-op amp, instrumentation amplifier configuration shown in Figure2,

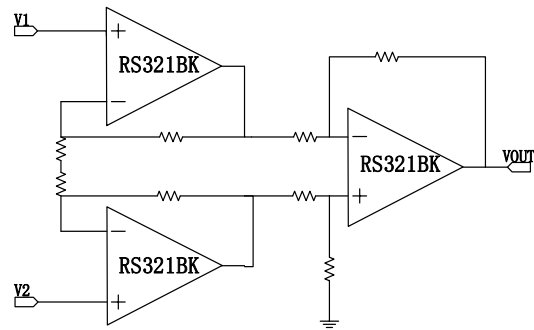

Figure2. Amplifier instrumentation amplifier

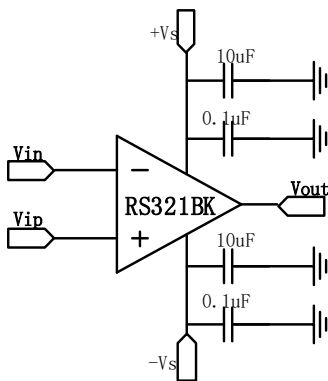
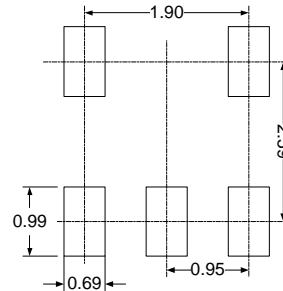
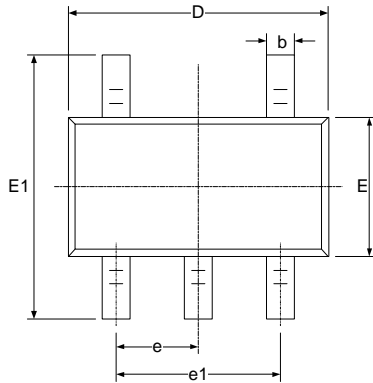

Figure1. Amplifier with Bypass Capacitors



# PACKAGE OUTLINE DIMENSIONS

## SOT23-5



**RECOMMENDED LAND PATTERN (Unit: mm)**

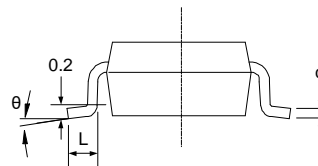
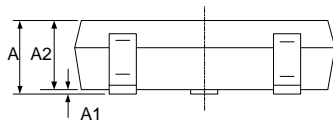

Symbol	Dimensions In Millimeters		Dimensions In Inches	
	Min	Max	Min	Max
A	1.050	1.250	0.041	0.049
A1	0.000	0.100	0.000	0.004
A2	1.050	1.150	0.041	0.045
b	0.300	0.500	0.012	0.020
c	0.100	0.200	0.004	0.008
D	2.820	3.020	0.111	0.119
E	1.500	1.700	0.059	0.067
E1	2.650	2.950	0.104	0.116
e	0.950(BSC)		0.037(BSC)	
e1	1.800	2.000	0.071	0.079
L	0.300	0.600	0.012	0.024
$\theta$	0°	8°	0°	8°

# SOT353(SC70-5)

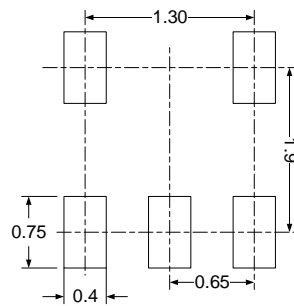
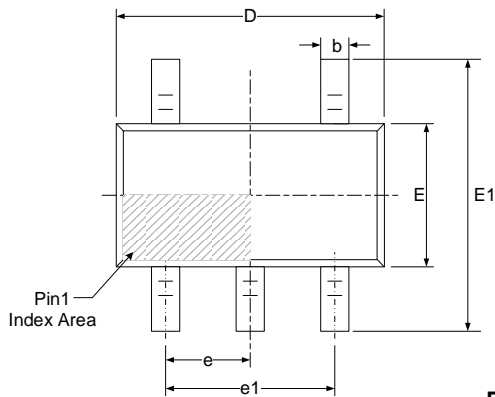
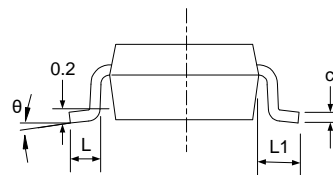
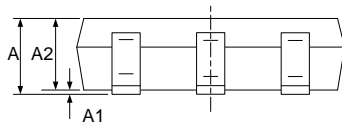
**RECOMMENDED LAND PATTERN (Unit: mm)**

Symbol	Dimensions In Millimeters		Dimensions In Inches	
	Min	Max	Min	Max
A	0.900	1.100	0.035	0.043
A1	0.000	0.100	0.000	0.004
A2	0.900	1.000	0.035	0.039
b	0.150	0.350	0.006	0.014
c	0.080	0.150	0.003	0.006
D	2.000	2.200	0.079	0.087
E	1.150	1.350	0.045	0.053
E1	2.150	2.450	0.085	0.096
e	0.650(BSC)		0.026(BSC)	
e1	1.300(BSC)		0.051(BSC)	
L	0.260	0.460	0.010	0.018
L1	0.525		0.021	
θ	0°	8°	0°	8°

单击下面可查看定价，库存，交付和生命周期等信息

[>>润石](#)