

Electrical Features

- Low Switching Losses
- Trench/Fieldstop IGBT
- V_{CEsat} with positive Temperature Coefficient
- Low V_{CEsat}

Typical Applications

- Auxiliary Inverters
- Air Conditioning
- Motor Drives



Mechanical Features

- Al_2O_3 Substrate with Low Thermal Resistance
- Compact design
- Solder Contact Technology
- Rugged mounting due to integrated mounting clamps

IGBT, Inverter

Maximum Rated Values							
Symbol	Item	Conditions	Rating			Unit	
IGBT							
V_{CES}	Collector-emitter voltage	$T_{vj}=25^{\circ}C$	1200			V	
V_{GES}	Gate-emitter voltage	-	± 20			V	
I_C	Collector current,DC	$T_C=100^{\circ}C, T_{vj}=175^{\circ}C$	25			A	
I_{CRM}	Repetitive peak collector current	$t_p=1ms$	50			A	
P_{tot}	Total power dissipation	$T_C=25^{\circ}C, T_{vj}=175^{\circ}C$	176			W	
Characteristics Values							
Symbol	Item	Conditions	Values			Unit	
IGBT			Min.	Typ.	Max.		
I_{CES}	Collector-emitter cut-off current	$V_{CE}=1200V, V_{GE}=0V, T_{vj}=25^{\circ}C$	-	-	1	mA	
I_{GES}	Gate leakage current	$V_{CE}=0V, V_{GE}=20V, T_{vj}=25^{\circ}C$	-	-	500	nA	
$V_{GE(th)}$	Gate-emitter threshold voltage	$I_C=0.8mA, V_{CE}=V_{GE}, T_{vj}=25^{\circ}C$	5.2	5.77	6.5	V	
V_{CEsat}	Collector-emitter saturation voltage	$I_C=25A$ $V_{GE}=15V$	$T_{vj}=25^{\circ}C$	-	2.04	-	V
			$T_{vj}=125^{\circ}C$	-	2.43	-	
			$T_{vj}=150^{\circ}C$	-	2.53	-	
C_{ies}	Input capacitance	$V_{CE}=25V, V_{GE}=0V$ $f=1MHz, T_{vj}=25^{\circ}C$	-	1.77	-	nF	
C_{oes}	Output capacitance		-	0.17	-		
C_{res}	Reverse transfer capacitance		-	0.06	-		
Q_G	Gate charge	$V_{CC}=600V, I_C=25A$ $V_{GE}=-15...+15V, T_{vj}=25^{\circ}C$	-	0.171	-	μC	
R_g	Internal gate resistance	$T_{vj}=25^{\circ}C$	-	-	-	Ω	

$t_{d(on)}$	Turn-on delay time	$V_{CC}=600V$ $I_C=25A$ $V_{GE}=\pm 15V$ $R_{G(on)}=20\Omega$ $R_{G(off)}=20\Omega$	$T_{vj}=25^\circ C$	-	56.5	-	ns
			$T_{vj}=125^\circ C$	-	43.2	-	
			$T_{vj}=150^\circ C$	-	40.5	-	
t_r	Rise time		$T_{vj}=25^\circ C$	-	60.0	-	
			$T_{vj}=125^\circ C$	-	63.4	-	
			$T_{vj}=150^\circ C$	-	64.8	-	
$t_{d(off)}$	Turn-off delay time		$T_{vj}=25^\circ C$	-	129.0	-	
			$T_{vj}=125^\circ C$	-	145.3	-	
			$T_{vj}=150^\circ C$	-	150.4	-	
t_f	Fall time		$T_{vj}=25^\circ C$	-	196.5	-	
			$T_{vj}=125^\circ C$	-	320.2	-	
			$T_{vj}=150^\circ C$	-	329.3	-	
E_{on}	Turn-on energy (per pulse)	$T_{vj}=25^\circ C$	-	3.21	-	mJ	
		$T_{vj}=125^\circ C$	-	4.31	-		
		$T_{vj}=150^\circ C$	-	4.77	-		
E_{off}	Turn-off energy (per pulse)	$T_{vj}=25^\circ C$	-	1.32	-		
		$T_{vj}=125^\circ C$	-	1.84	-		
		$T_{vj}=150^\circ C$	-	1.98	-		
SC data	Short-circuit current	$V_{CC}=600V, V_{GE}\leq 15V, T_{vj}=125^\circ C$ $V_{CES}\leq 1200V, t_p\leq 10\mu s$	-	107	-	A	
R_{thJC}	Thermal resistance, junction to case	Per IGBT	-	0.75	0.85	K/W	
R_{thCH}	Thermal resistance, case to heatsink	Per IGBT $\lambda_{grease}=1W/(m\cdot K)$	-	0.7	-	K/W	
T_{vjop}	Temperature under switching conditions		-40		150	$^\circ C$	

Diode, Inverter
Maximum Rated Values

Symbol	Item	Conditions	Rating	Unit
V_{RRM}	Repetitive peak reverse voltage	$T_{vj}=25^\circ C$	1200	V
I_F	Forward current, DC		25	A
I_{FRM}	Repetitive peak forward current	$t_p=1ms$	50	A
I^2t	I^2t -value	$V_R=0V, t_p=10ms, T_{vj}=150^\circ C$	75	A^2s

Characteristic Values

V_F	Continuous forward voltage	$I_F=25A$ $V_{GE}=0V$	$T_{vj}=25^\circ C$	-	2.12	-	V
			$T_{vj}=125^\circ C$	-	1.85	-	
			$T_{vj}=150^\circ C$	-	1.79	-	
I_{RM}	Peak reverse recovery current		$T_{vj}=25^\circ C$	-	21.9	-	A
			$T_{vj}=125^\circ C$	-	24.7	-	
			$T_{vj}=150^\circ C$	-	26.5	-	
t_{rr}	Reverse recovery time	$V_R=600V$ $I_F=25A$ $V_{GE}=-15V$	$T_{vj}=25^\circ C$	-	62.8	-	ns
			$T_{vj}=125^\circ C$	-	574	-	
			$T_{vj}=150^\circ C$	-	690	-	
Q_r	Recovered charge		$T_{vj}=25^\circ C$	-	1.78	-	μC
			$T_{vj}=125^\circ C$	-	5.61	-	
			$T_{vj}=150^\circ C$	-	6.51	-	

E _{rec}	Reverse recovery energy		T _{vj} =25°C	-	1.82	-	mJ
			T _{vj} =125°C	-	2.48	-	
			T _{vj} =150°C	-	2.86	-	
R _{thJC}	Thermal resistance, junction to case	per diode	-	1.10	1.20	K/W	
R _{thCH}	Thermal resistance, case to heatsink	per diode, λ _{grease} =1 W/(m • K)	-	0.9	-	K/W	
T _{vjop}	Temperature under switching conditions		-40		150	°C	

Diode, Rectifier

Maximum Rated Values							
Symbol	Item	Conditions		Rating			Unit
V _{RRM}	Repetitive peak reverse voltage	T _{vj} =25°C		1800			V
I _{FRMSM}	Maximum RMS forward current per chip	T _C =80°C, T _{vj} =175°C		60			A
I _{RMSM}	Maximum RMS current at rectifier output	T _C = 80°C		60			A
I _{FSM}	Surge forward current	t _p =10 ms, T _{vj} =150°C		370			A
I ² t	I ² t-value	V _R =0V, t _p =10ms, T _{vj} =150°C		685			A ² s
Characteristic Values							
Symbol	Item	Conditions	Values			Unit	
			Min.	Typ.	Max.		
V _F	Continuous forward voltage	I _F =25A V _{GE} =0V	T _{vj} =25°C	-	1.12	-	V
			T _{vj} =125°C	-	-	-	
			T _{vj} =150°C	-	-	-	
I _R	Reverse current	V _R =1800V	T _{vj} =25°C	-	-	10	μA
			T _{vj} =125°C	-	-	-	
			T _{vj} =150°C	-	-	-	
R _{thJC}	Thermal resistance, junction to case	per diode	-	1.05	1.15	K/W	
R _{thCH}	Thermal resistance, case to heatsink	per diode, λ _{grease} =1 W/(m • K)	-	0.95	-	K/W	
T _{vjop}	Temperature under switching conditions		-40		150	°C	

IGBT, Brake-Chopper

Maximum Rated Values							
Symbol	Item	Conditions		Values			Unit
V _{CES}	Collector-emitter voltage	T _{vj} =25°C		1200			V
V _{GES}	Gate-emitter voltage	-		±20			V
I _C	Collector current,DC	T _C =100°C, T _{vj} =175°C		25			A
I _{CRM}	Repetitive peak collector current	t _p =1ms		50			A
P _{tot}	Total power dissipation	T _C =25°C, T _{vj} =175°C		175			W
Characteristic Values							
Symbol	Item	Conditions	Values			Unit	
			Min.	Typ.	Max.		
IGBT	Collector-emitter cut-off current	V _{CE} =1200V, V _{GE} =0V, T _{vj} =25°C	-	-	1	mA	
			-	-	500		
			-	-	500		
I _{GES}	Gate leakage current	V _{CE} =0V, V _{GE} =20V, T _{vj} =25°C	-	-	500	nA	
V _{GE(th)}	Gate-emitter threshold voltage	I _C =0.8mA, V _{CE} =V _{GE} , T _{vj} =25°C	5.2	5.7	6.5	V	

V_{CEsat}	Collector-emitter saturation voltage	$I_C=25A$ $V_{GE}=15V$	$T_{vj}=25^{\circ}C$	-	2.24	-	V
			$T_{vj}=125^{\circ}C$	-	2.41	-	
			$T_{vj}=150^{\circ}C$	-	2.83	-	
C_{ies}	Input capacitance	$V_{CE}=25V, V_{GE}=0V$ $f=1MHz, T_{vj}=25^{\circ}C$	-	1.77	-	nF	
C_{oes}	Output capacitance		-	0.17	-		
C_{res}	Reverse transfer capacitance		-	0.06	-		
Q_G	Gate charge	$V_{CC}=600V, I_C=25A$ $V_{GE}=-15...+15V, T_{vj}=25^{\circ}C$	-	0.171	-	μC	
R_g	Internal gate resistance	$T_{vj}=25^{\circ}C$	-	-	-	Ω	
$t_{d(on)}$	Turn-on delay time	$V_{CC}=600V$ $I_C=25A$ $V_{GE}=\pm 15V$ $R_{G(on)}=20\Omega$ $R_{G(off)}=20\Omega$	$T_{vj}=25^{\circ}C$	-	51.2	-	ns
			$T_{vj}=125^{\circ}C$	-	45.6	-	
			$T_{vj}=150^{\circ}C$	-	43.2	-	
t_r	Rise time		$T_{vj}=25^{\circ}C$	-	88.8	-	
			$T_{vj}=125^{\circ}C$	-	84.8	-	
			$T_{vj}=150^{\circ}C$	-	85.6	-	
$t_{d(off)}$	Turn-off delay time		$T_{vj}=25^{\circ}C$	-	133.6	-	
			$T_{vj}=125^{\circ}C$	-	150.4	-	
			$T_{vj}=150^{\circ}C$	-	156.0	-	
t_f	Fall time	$T_{vj}=25^{\circ}C$	-	200.1	-		
		$T_{vj}=125^{\circ}C$	-	262.4	-		
		$T_{vj}=150^{\circ}C$	-	339.2	-		
E_{on}	Turn-on energy (per pulse)	$T_{vj}=25^{\circ}C$	-	3.46	-	mJ	
		$T_{vj}=125^{\circ}C$	-	4.06	-		
		$T_{vj}=150^{\circ}C$	-	4.20	-		
E_{off}	Turn-off energy (per pulse)	$T_{vj}=25^{\circ}C$	-	1.42	-		
		$T_{vj}=125^{\circ}C$	-	2.01	-		
		$T_{vj}=150^{\circ}C$	-	2.11	-		
SC data	Short-circuit current	$V_{CC}=600V, V_{GE}\leq 15V, T_{vj}=125^{\circ}C$ $V_{CES}\leq 1200V, t_p\leq 10\mu s$	-	100	-	A	
R_{thJC}	Thermal resistance, junction to case	Per IGBT	-	0.75	0.85	K/W	
R_{thCH}	Thermal resistance, case to heatsink	Per IGBT $\lambda_{grease}=1W/(m\cdot K)$	-	0.70	-	K/W	
T_{vjop}	Temperature under switching conditions		-40		150	$^{\circ}C$	
Diode, Brake-Chopper							
Maximum Rated Values							
Symbol	Item	Conditions		Rating		Unit	
V_{RRM}	Repetitive peak reverse voltage	$T_{vj}=25^{\circ}C$		1200		V	
I_F	Forward current, DC			10		A	
I_{FRM}	Repetitive peak forward current	$t_p=1ms$		20		A	
I^2t	I^2t -value	$V_R=0V, t_p=10ms, T_{vj}=125^{\circ}C$		16		A^2s	
Characteristic Values							
V_F	Continuous forward voltage	$I_F=10A$ $V_{GE}=0V$	$T_{vj}=25^{\circ}C$	-	2.31	-	V
			$T_{vj}=125^{\circ}C$	-	2.13	-	
			$T_{vj}=150^{\circ}C$	-	2.03	-	

I _{RM}	Peak reverse recovery current	V _R =600V I _F =10A V _{GE} =-15V	T _{vj} =25°C	-	22.74	-	A
			T _{vj} =125°C	-	24.8	-	
			T _{vj} =150°C	-	25.2	-	
t _{rr}	Reverse recovery time		T _{vj} =25°C	-	42.5	-	ns
			T _{vj} =125°C	-	105.1	-	
			T _{vj} =150°C	-	199.6	-	
Q _r	Recovered charge		T _{vj} =25°C	-	0.68	-	μC
			T _{vj} =125°C	-	4.23	-	
			T _{vj} =150°C	-	4.95	-	
E _{rec}	Reverse recovery energy		T _{vj} =25°C	-	0.02	-	mJ
			T _{vj} =125°C	-	1.85	-	
			T _{vj} =150°C	-	2.23	-	
R _{thJC}	Thermal resistance, junction to case	per diode	-	1.75	1.90	K/W	
R _{thCH}	Thermal resistance, case to heatsink	per diode, λ _{grease} =1 W/(m • K)	-	1.30	-	K/W	
T _{vjop}	Temperature under switching conditions			-40	150	°C	

Note:

IGBT electrical characteristics according to IEC 60747 – 9

Diode electrical characteristics according to IEC 60747 – 2

NTC Thermistor Characteristics

Symbol	Item	Conditions	Values			Unit
			Min.	Typ.	Max.	
R ₂₅	Rated resistance	T _C =25°C	-	5	-	kΩ
ΔR/R	Deviation of resistance	T _C =100°C, R ₁₀₀ =493Ω	-5	-	5	%
P ₂₅	Power dissipation	T _C =25°C	-	-	20	mW
B _{25/50}	B-constant	R ₂ =R ₂₅ exp[B _{25/50} (1/T ₂ -1/(298.15K))]	-	3375	-	K
B _{25/80}	B-constant	R ₂ =R ₂₅ exp[B _{25/80} (1/T ₂ -1/(298.15K))]	-	3411	-	
B _{25/100}	B-constant	R ₂ =R ₂₅ exp[B _{25/100} (1/T ₂ -1/(298.15K))]	-	3433	-	

Module

Symbol	Item	Conditions	Rating			Unit
V _{ISOL}	Isolation voltage	Terminals to baseplate, RMS, f=50Hz, t=1min	2500			V
T _{vj max}	Maximum junction temperature	-	175			°C
T _{vj op}	Operating junction temperature	Continuous operation(underswitching)	-40~150			°C
T _{stg}	Storage temperature	-	-40~125			°C
Symbol	Item	Conditions	Values			Unit
			Min.	Typ.	Max.	
F	mounting force per clamp	-	40	-	80	N
ds	Creepage distance	Terminal to terminal	-	6.3	-	mm
		Terminal to base plate	-	11.5	-	
da	Clearance	Terminal to terminal	-	5	-	mm
		Terminal to base plate	-	10	-	
m	Weight	-	-	38	-	g

output characteristic IGBT,Inverter (typical)

$I_C = f(V_{CE})$

$V_{GE} = 15V$

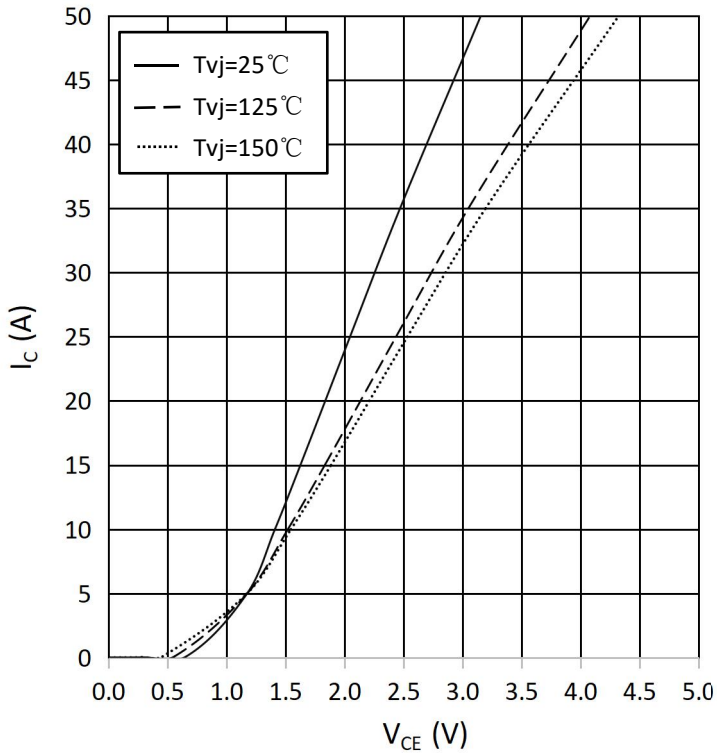

output characteristic IGBT,Inverter (typical)

$I_C = f(V_{CE})$

$T_{vj} = 150^\circ C$

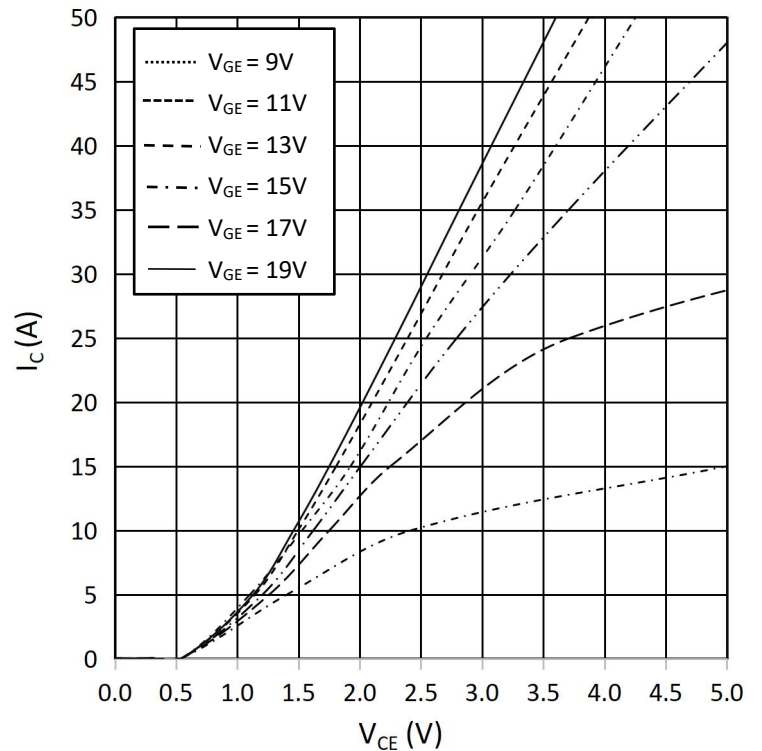

switching losses IGBT,Inverter (typical)

$E_{on} = f(I_C), E_{off} = f(I_C)$

$V_{GE} = \pm 15V, R_{Gon} = 20\Omega, R_{Goff} = 20\Omega, V_{CE} = 600V$

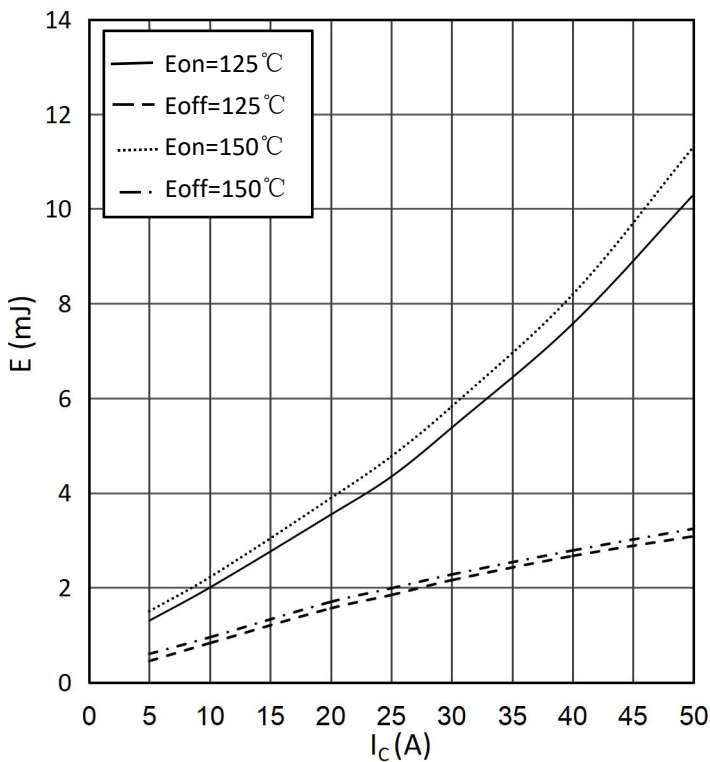

switching losses IGBT,Inverter (typical)

$E_{on} = f(R_G), E_{off} = f(R_G)$

$V_{GE} = \pm 15V, I_C = 25A, V_{CE} = 600V$

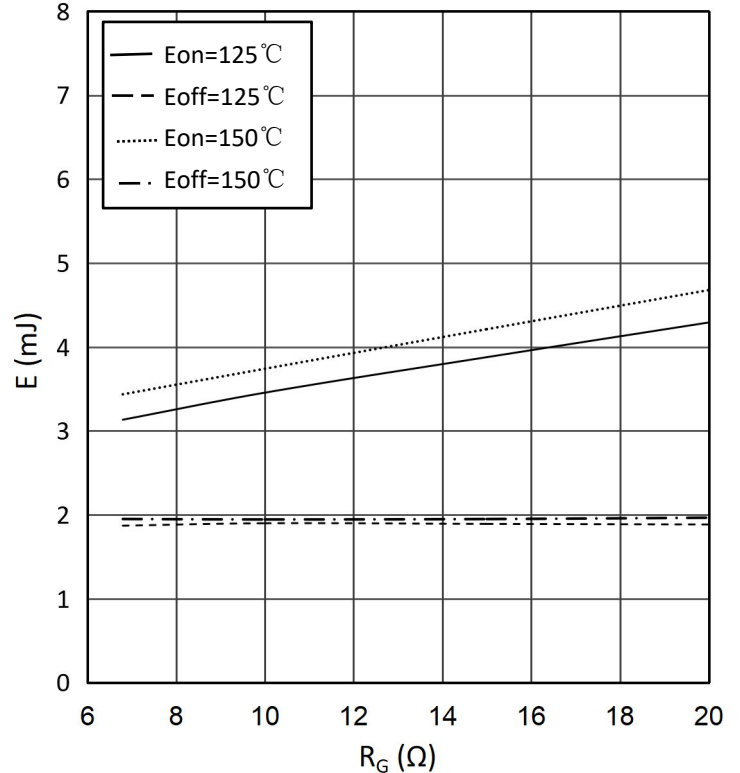

forward characteristic of Diode, Inverter (typical)

$I_F = f(V_F)$

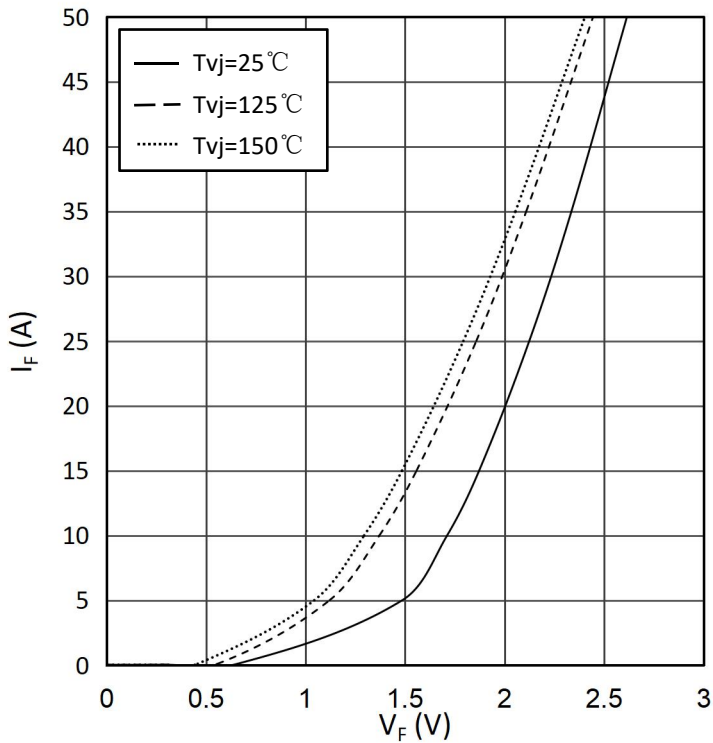

switching losses Diode, Inverter (typical)

$E_{rec} = f(I_F)$

$R_{Gon} = 20\Omega, V_{CE} = 600$

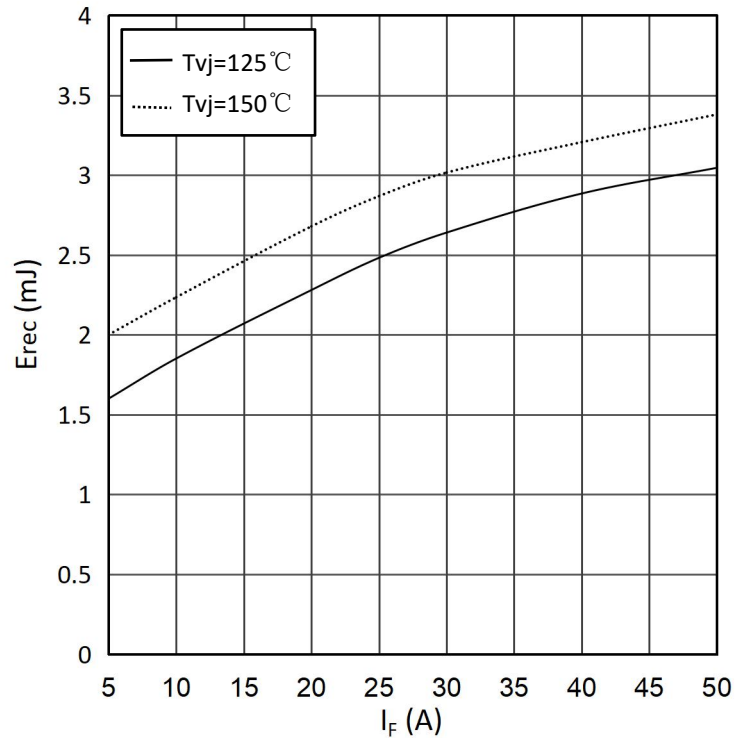

switching losses Diode, Inverter (typical)

$E_{rec} = f(R_G)$

$I_F = 25\text{A}, V_{CE} = 600\text{V}$

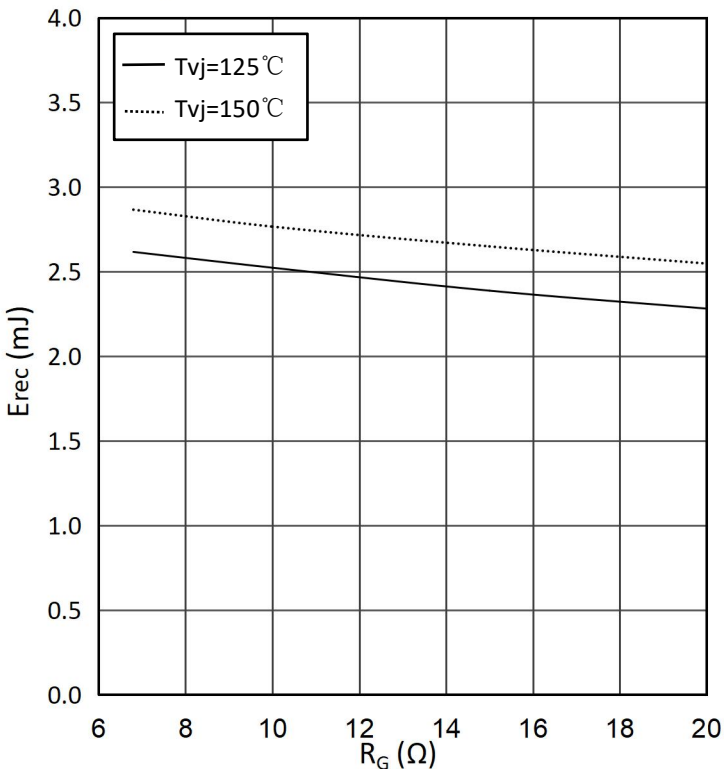

output characteristic IGBT, Brake-Chopper (typical)

$I_C = f(V_{CE})$

$V_{GE} = 15\text{V}$

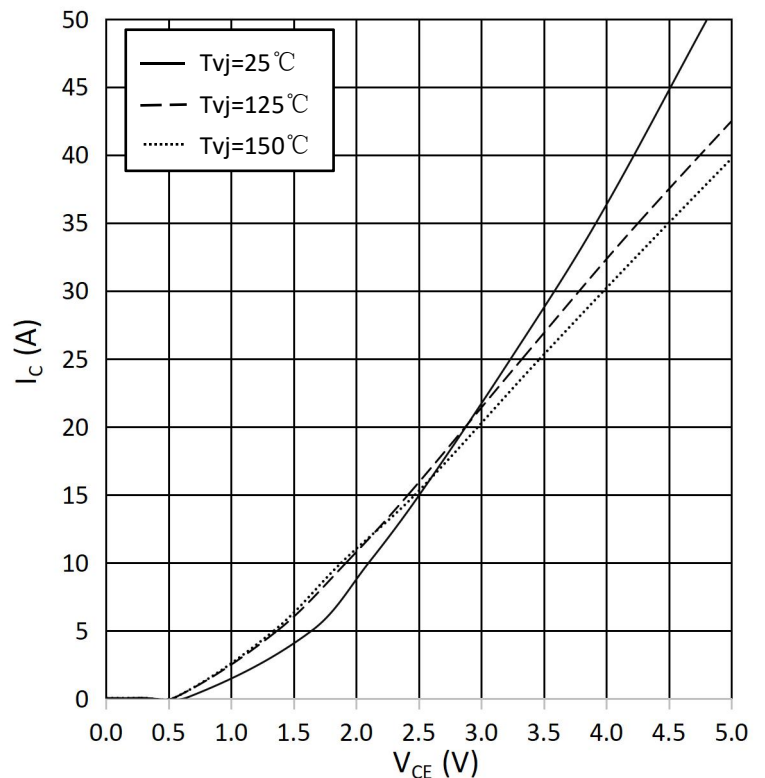

forward characteristic of Diode, Brake-Chopper (typical)

$I_F = f(V_F)$

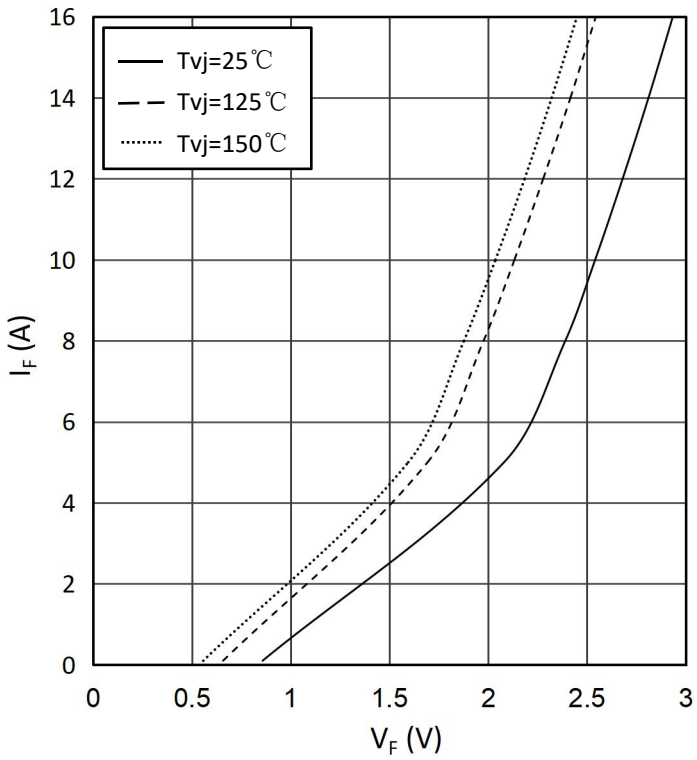

NTC-Thermistor-temperature characteristic(typical)

$R=f(T)$

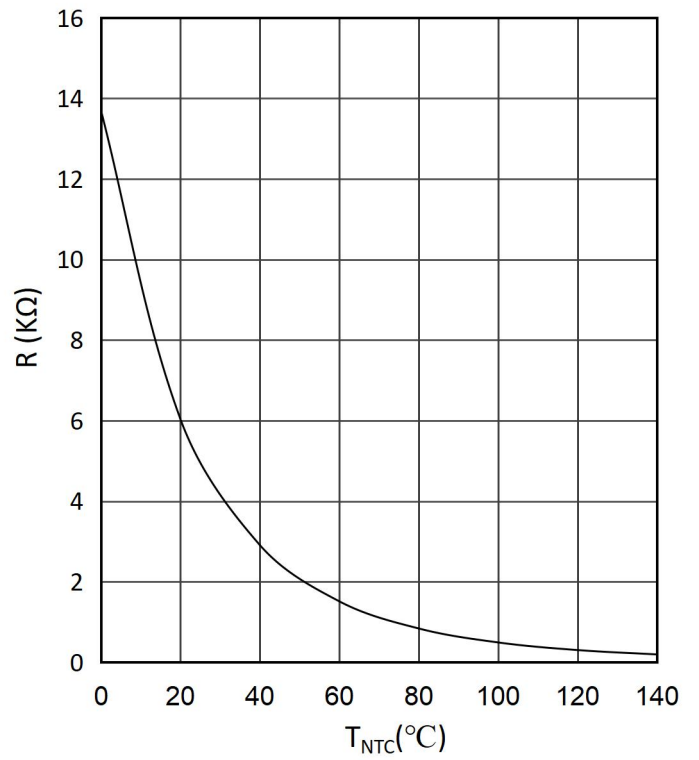

Circuit Diagram

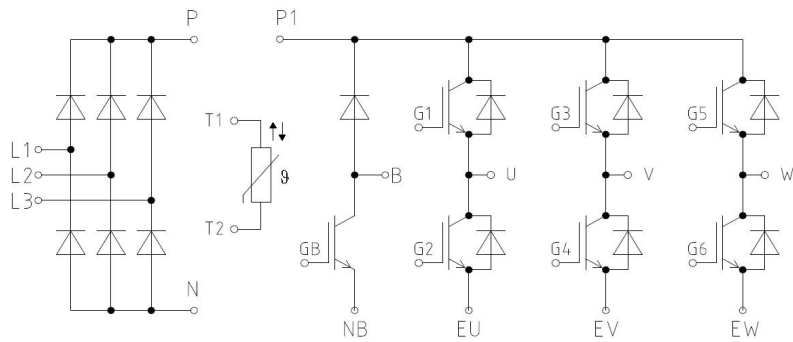

Package Outlines

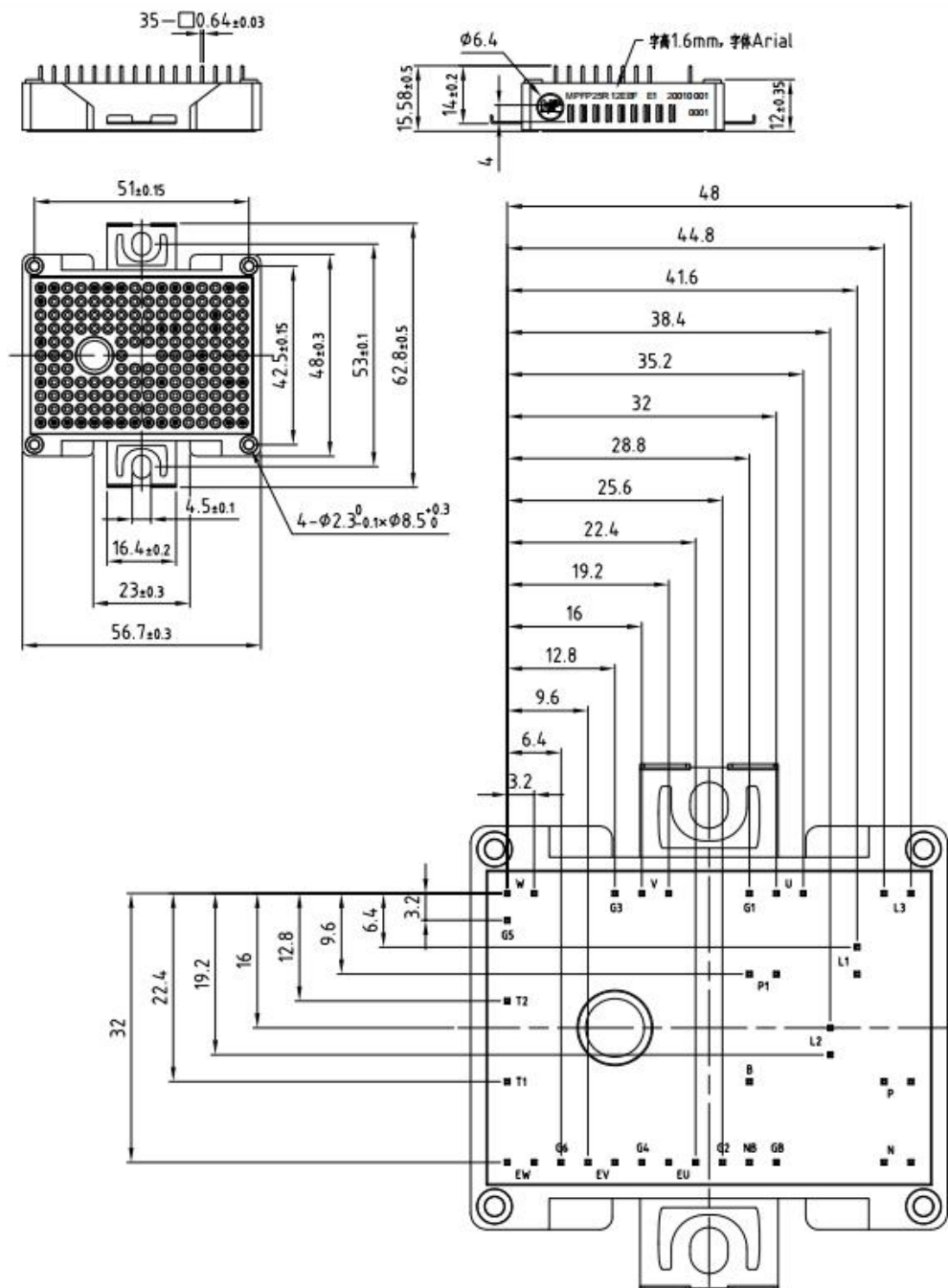

Terms & Conditions of usage

- 1.The product specifications, characteristics, data, materials and structures given in this datasheet are subject to change without notice.
- 2.The information given in this datasheet shall in no event be regarded as a guarantee of conditions or characteristics. Marching-Power Technology Co., Ltd. does not warrant or assume any legal liability or responsibility for the accuracy and completeness of any examples, hints or any typical values stated herein and/or any information regarding the application of the product.
- 3.This datasheet is only used as a reference for customers to apply our products, Marching-Power Technology Co., Ltd. does not undertake to permit the use of intellectual property rights or any third-party property rights related to the product information described in this datasheet.
- 4.Although Marching-Power Technology Co., Ltd. is committed to enhancing product quality and reliability, all semiconductor products still have a probability of failure. When using Marching-Power semiconductor products in your equipment, you are requested to take adequate safety measures to prevent the equipment from causing accidents or events including but not limited to physical injury, fire or damage to other property if any of the products become faulty.
- 5.The products introduced in this datasheet are electrostatic sensitive devices and must be protected against static electricity during device installation, testing, packaging, storage and transportation.
- 6.Due to technical requirements our product may contain dangerous substances. For information on the types in question please contact the sales office, which is responsible for you.
- 7.Do not use the products introduced in this datasheet in equipment or systems that requiring strict reliability or/and may directly endanger human life such as medical, life-saving, life-sustaining, space equipment, aeronautic equipment, nuclear equipment submarine repeater equipment and equivalents to strategic equipment (without limitation).
- 8.No part of this datasheet may be disseminated and reproduced in any form or by any means without prior written permission from Marching-Power Technology Co., Ltd.
- 9.The data contained in this datasheet is exclusively intended for use by professional technicians only. It is the responsibility of the customer's own technical departments to evaluate the suitability of the product for the intended application and the completeness of the product information given in this document with respect to corresponding application. If you have any question about any portion in this datasheet, contact Marching-Power Technology Co., Ltd. before using the product. Marching-Power Technology Co., Ltd. shall not be liable for any injury caused by any use of the products not in accordance with instructions set forth herein.

单击下面可查看定价，库存，交付和生命周期等信息

[>>芯长征](#)