

## Features

- Easy parallel switching capability due to positive temperature coefficient in  $V_{CEsat}$
- Low  $V_{CEsat}$ , fast switching
- High ruggedness, good thermal stability
- Very tight parameter distribution

Type	Marking	Package Code
MPBQ75N120E	MP75N120E	TO-247-3L Plus

## Applications

- Industrial UPS
- Charger
- EnergyStorage
- Welding

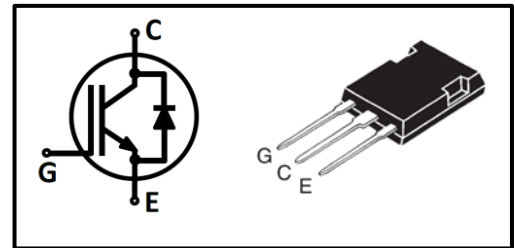

## Maximum Rated Values

Parameter	Symbol	Value	Unit
Collector-emitter voltage	$V_{CE}$	1200	V
DC collector current, limited by $T_{jmax}$ $T_C=25^\circ C$ $T_C=100^\circ C$	$I_C$	150 75	A
Pulsed collector current, $t_p$ limited by $T_{jmax}^{1)}$	$I_{Cpuls}$	225	
Diode forward current, limited by $T_{jmax}$ $T_C=25^\circ C$ $T_C=100^\circ C$	$I_F$	150 75	
Diode pulsed current, $t_p$ limited by $T_{jmax}^{1)}$	$I_{Fpuls}$	300	V
Gate-emitter voltage	$V_{GE}$	$\pm 20$	
Transient Gate-emitter voltage ( $t_p \leq 10\mu s, D < 0.01$ )		$\pm 30$	
Short circuit withstand time $V_{GE}=15V, V_{CC}=600V, T_j \leq 175^\circ C$ Allowed number of short circuits < 1000 Time between short circuits: $\geq 1.0s$	$t_{SC}$	10	$\mu s$
Power dissipation $T_C=25^\circ C$	$P_{tot}$	833	W
Power dissipation $T_C=100^\circ C$		416	
Operating junction temperature	$T_j$	-40~175	$^\circ C$
Storage temperature	$T_{stg}$	-55~150	
Soldering temperature, wave soldering 1.6mm (0.063in.) from case for 10s		260	

<sup>1)</sup> Defined by design. Not subject to production test.



## Thermal Characteristics

Parameter	Symbol	Min	Typ	Max	Unit
IGBT thermal resistance, junction-case	$R_{thJC}$	-	-	0.18	K/W
Diode thermal resistance, junction-case	$R_{thJCD}$	-	-	0.30	
Thermal Resistance, junction-ambient	$R_{thJA}$	-	-	40	

## Electrical Characteristics (at $T_j=25^\circ\text{C}$ , unless otherwise specified) Static Characteristics

Parameter	Symbol	Conditions	Min	Typ	Max	Unit
Collector-emitter breakdown voltage	$V_{(BR)CES}$	$V_{GE}=0V, I_C=0.25mA$	1200	-	-	V
Collector-emitter saturation voltage	$V_{CE(sat)}$	$V_{GE}=15V, I_C=75A$ $T_j=25^\circ\text{C}$	-	1.58	1.80	
		$T_j=125^\circ\text{C}$	-	2.09	-	
		$T_j=150^\circ\text{C}$	-	2.21	-	
		$T_j=175^\circ\text{C}$	-	2.34	-	
G-E threshold voltage	$V_{GE(th)}$	$I_C=2.4mA, V_{CE}=V_{GE}$	5.0	5.6	6.2	
C-E leakage current	$I_{CES}$	$V_{CE}=1200V, V_{GE}=0V$ $T_j=25^\circ\text{C}$	-	-	0.1	mA
		$T_j=175^\circ\text{C}$	-	-	4.0	
G-E leakage current	$I_{GES}$	$V_{CE}=0V, V_{GE}=20V$	-	-	250	nA
Transconductance	$g_{fs}$	$V_{CE}=20V, I_C=75A$	-	30	-	S

## Dynamic Characteristics

Parameter	Symbol	Conditions	Min	Typ	Max	Unit
Input capacitance	$C_{ies}$	$V_{CE}=25V,$ $V_{GE}=0V,$ $f=1MHz$	-	11533	-	pF
Output capacitance	$C_{oes}$		-	253	-	
Reverse transfer capacitance	$C_{res}$		-	60	-	
Gate charge	$Q_G$	$V_{CC}=600V, I_C=75A,$ $V_{GE}=15V$	-	750	-	nC
Short circuit collector current	$I_{C(SC)}$	$V_{GE}=15V,$ $V_{CC}\leq 600V,$ $t_{SC}\leq 10\mu s, T_j=175^\circ\text{C}$	-	350	-	A
Internal emitter inductance measured 5mm (0.197 in.) from case	$L_E$		-	13	-	nH

## IGBT Switching Characteristics

Parameter	Symbol	Conditions	Min	Typ	Max	Unit	
Turn-on delay time	$t_{d(on)}$	$T_j=25^{\circ}\text{C}$ , $V_{CC}=600\text{V}$ , $I_C=75\text{A}$ , $V_{GE}=0\text{V}/15\text{V}$ , $R_G=10\Omega$ , Inductive load	-	151	-	ns	
Rise time	$t_r$		-	86	-		
Turn-off delay time	$t_{d(off)}$		-	488	-		
Fall time	$t_f$		-	55.6	-		
Turn-on energy	$E_{on}$		$T_j=175^{\circ}\text{C}$ , $V_{CC}=600\text{V}$ , $I_C=75\text{A}$ , $V_{GE}=0\text{V}/15\text{V}$ , $R_G=10\Omega$ , Inductive load	-	4.97	-	mJ
Turn-off energy	$E_{off}$			-	3.42	-	
Total switching energy	$E_{ts}$			-	8.39	-	
Turn-on delay time	$t_{d(on)}$	$T_j=175^{\circ}\text{C}$ , $V_{CC}=600\text{V}$ , $I_C=75\text{A}$ , $V_{GE}=0\text{V}/15\text{V}$ , $R_G=10\Omega$ , Inductive load	-	145	-	ns	
Rise time	$t_r$		-	86	-		
Turn-off delay time	$t_{d(off)}$		-	525	-		
Fall time	$t_f$		-	81.2	-		
Turn-on energy	$E_{on}$		$T_j=175^{\circ}\text{C}$ , $V_{CC}=600\text{V}$ , $I_C=75\text{A}$ , $V_{GE}=0\text{V}/15\text{V}$ , $R_G=10\Omega$ , Inductive load	-	5.21	-	mJ
Turn-off energy	$E_{off}$			-	3.98	-	
Total switching energy	$E_{ts}$			-	9.19	-	

## Diode Characteristics

Parameter	Symbol	Conditions	Min	Typ	Max	Unit
Diode forward voltage	$V_F$	$V_{GE}=0\text{V}$ , $I_F=75\text{A}$ $T_j=25^{\circ}\text{C}$	-	2.4	-	V
		$T_j=150^{\circ}\text{C}$	-	2.2	-	
		$T_j=175^{\circ}\text{C}$	-	2.1	-	
Diode reverse recovery time	$t_{rr}$	$T_j=25^{\circ}\text{C}$ , $V_R=600\text{V}$ , $I_F=75\text{A}$ , $di_F/dt=500\text{A}/\mu\text{s}$	-	255	-	ns
Diode reverse recovery charge	$Q_{rr}$		-	3.0	-	$\mu\text{C}$
Diode peak reverse recovery current	$I_{rrm}$		-	25.5	-	A
Diode reverse recovery time	$t_{rr}$	$T_j=175^{\circ}\text{C}$ , $V_R=600\text{V}$ , $I_F=75\text{A}$ , $di_F/dt=500\text{A}/\mu\text{s}$	-	271	-	ns
Diode reverse recovery charge	$Q_{rr}$		-	3.2	-	$\mu\text{C}$
Diode peak reverse recovery current	$I_{rrm}$		-	26.5	-	A

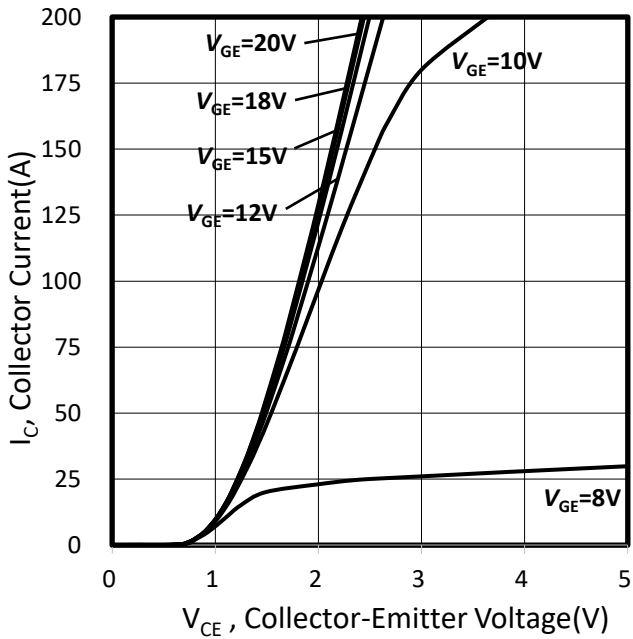

**Figure 1. Typical output characteristic**  
( $T_j=25^{\circ}\text{C}$ )

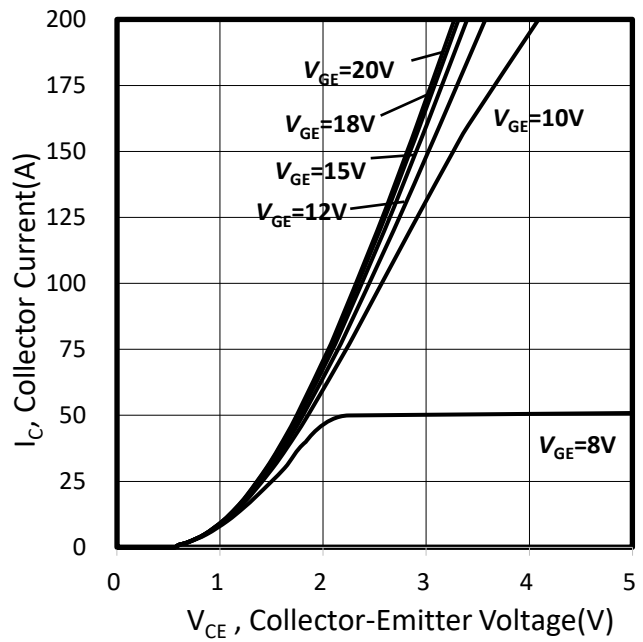

**Figure 2. Typical output characteristic**  
( $T_j=125^{\circ}\text{C}$ )

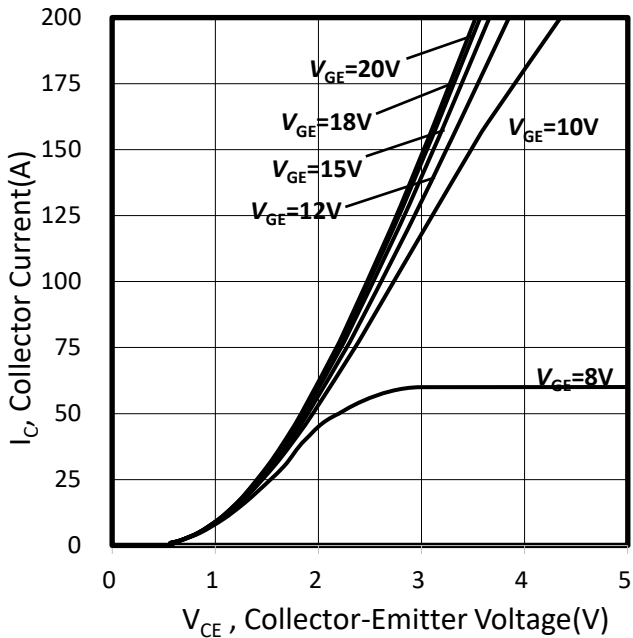

**Figure 3. Typical output characteristic**  
( $T_j=150^{\circ}\text{C}$ )

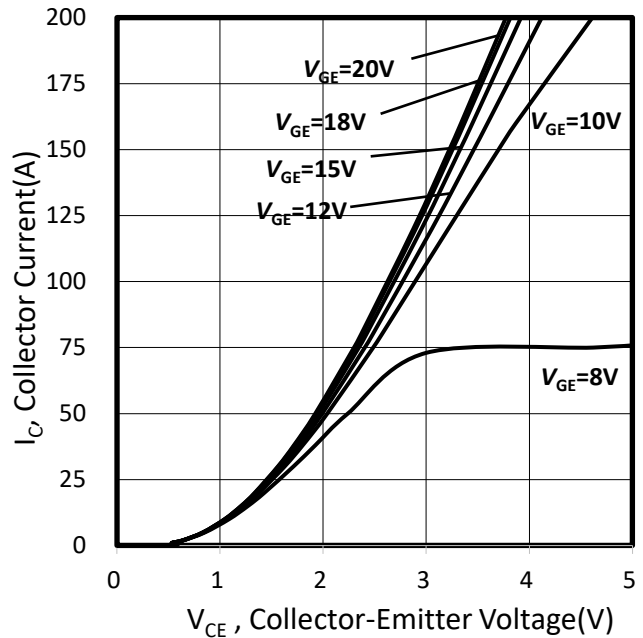

**Figure 4. Typical output characteristic**  
( $T_j=175^{\circ}\text{C}$ )

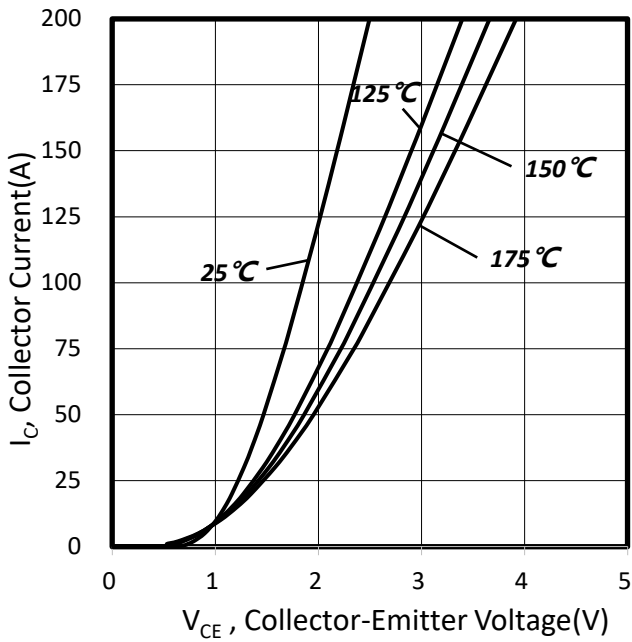

**Figure 5. Typical  $V_{CE(sat)}$ - $I_c$  characteristic ( $V_{GE}=15V$ )**

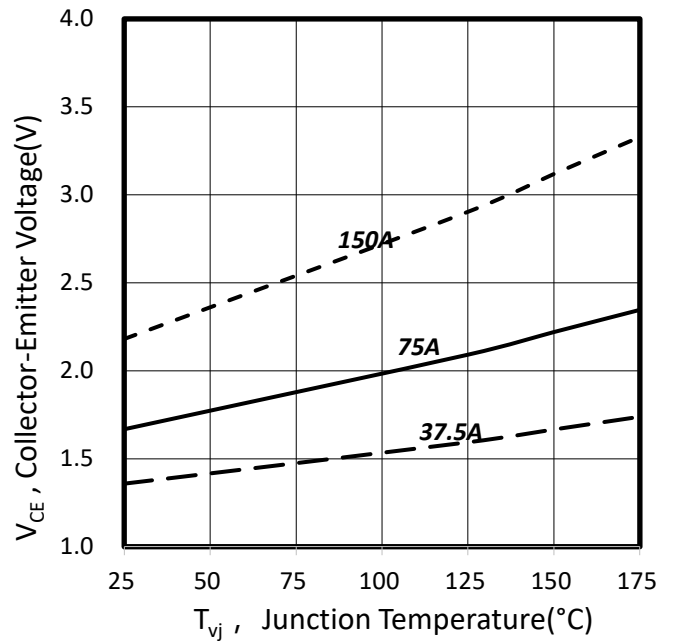

**Figure 6. Typical  $V_{CE(sat)}$ - $T_j$  characteristic ( $V_{GE}=15V$ )**

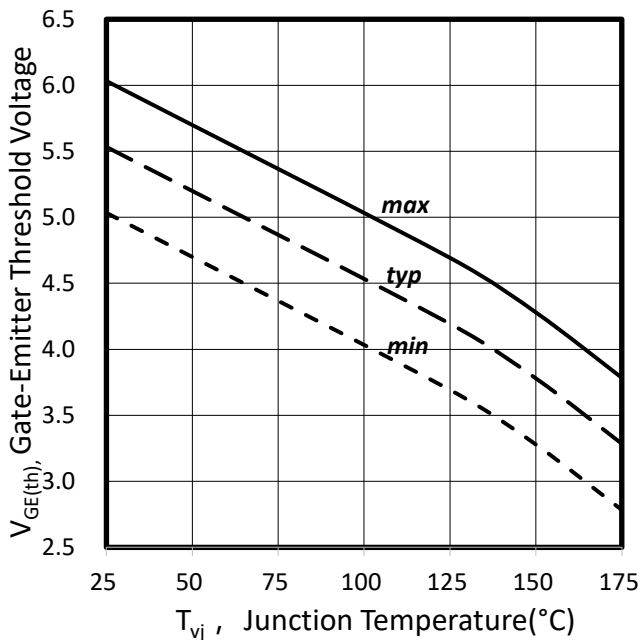

**Figure 7.  $V_{GE(th)}$ - $T_j$  characteristic ( $I_c=2.4mA$ )**

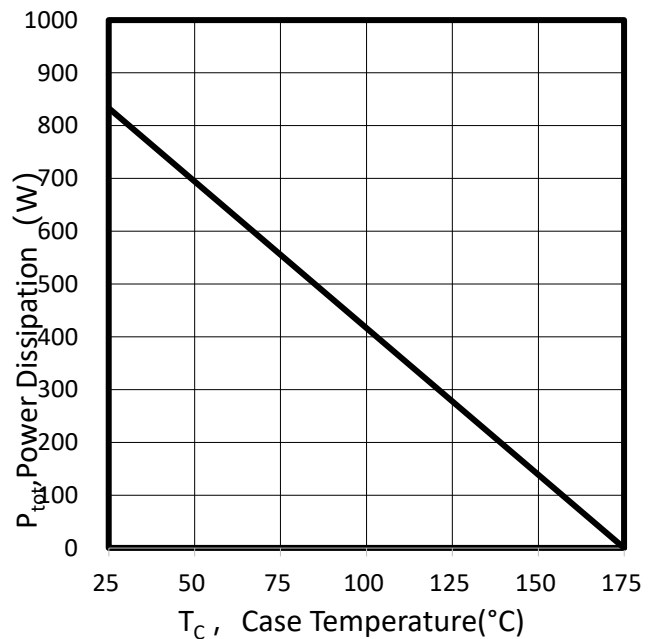

**Figure 8. Power dissipation as a function of case temperature ( $T_j \leq 175^\circ C$ )**

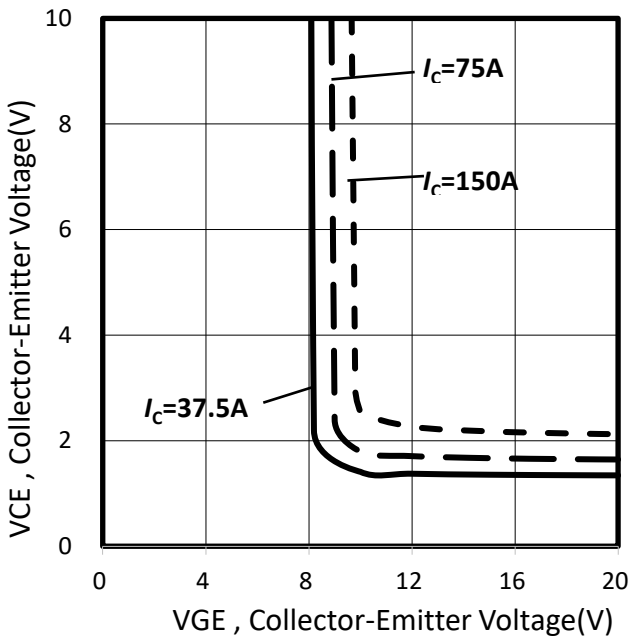

**Figure 9. Typical  $V_{CE(sat)}-V_{GE(th)}$  characteristic**  
( $T_{vj}=25^{\circ}C$ )

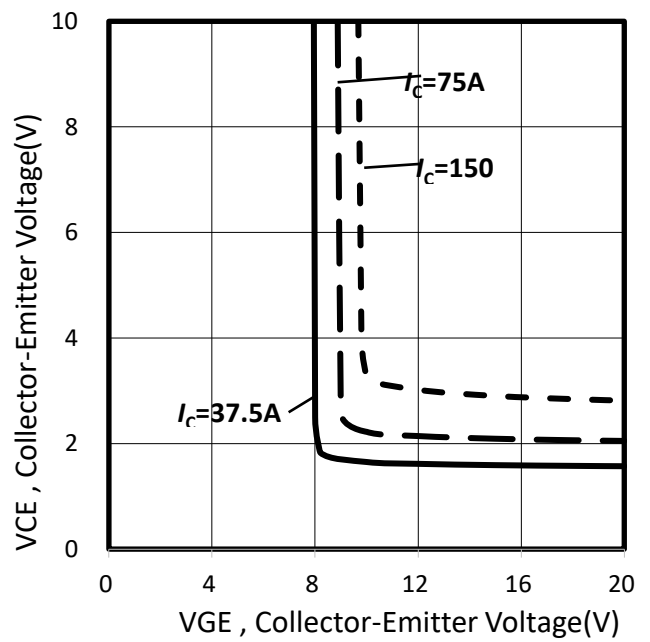

**Figure 10. Typical  $V_{CE(sat)}-V_{GE(th)}$  characteristic**  
( $T_{vj}=125^{\circ}C$ )

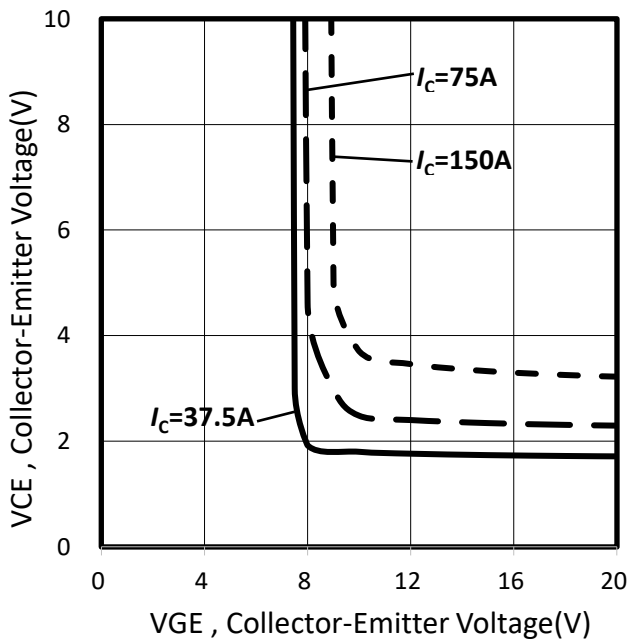

**Figure 11. Typical  $V_{CE(sat)}-V_{GE(th)}$  characteristic**  
( $T_{vj}=150^{\circ}C$ )

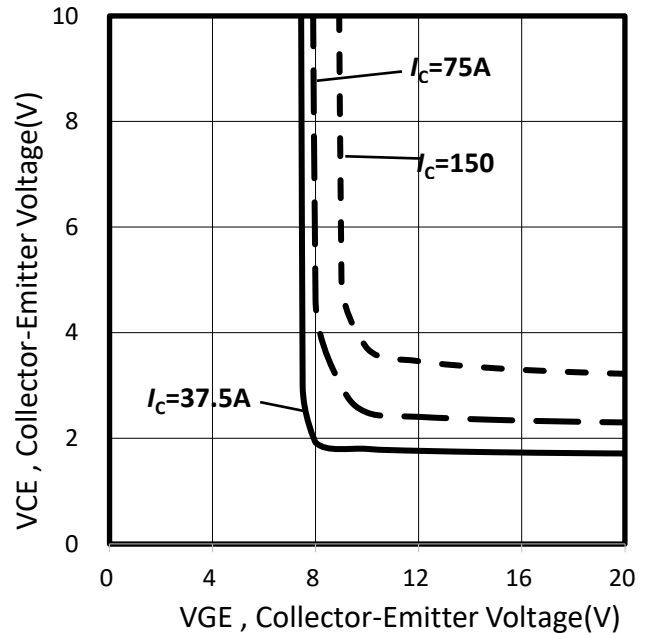

**Figure 12. Typical  $V_{CE(sat)}-V_{GE(th)}$  characteristic**  
( $T_{vj}=175^{\circ}C$ )

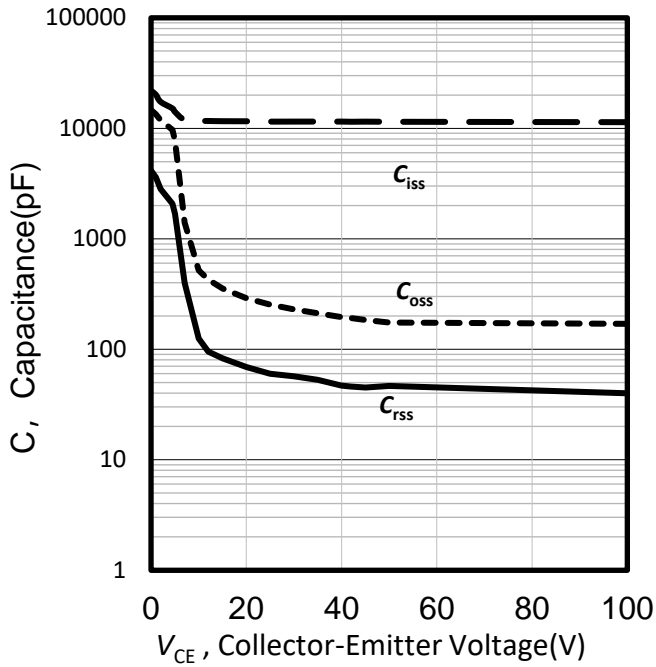

Figure 13. Typical capacitance as a function of collector-emitter voltage ( $V_{GE}=0V, f=1MHz$ )

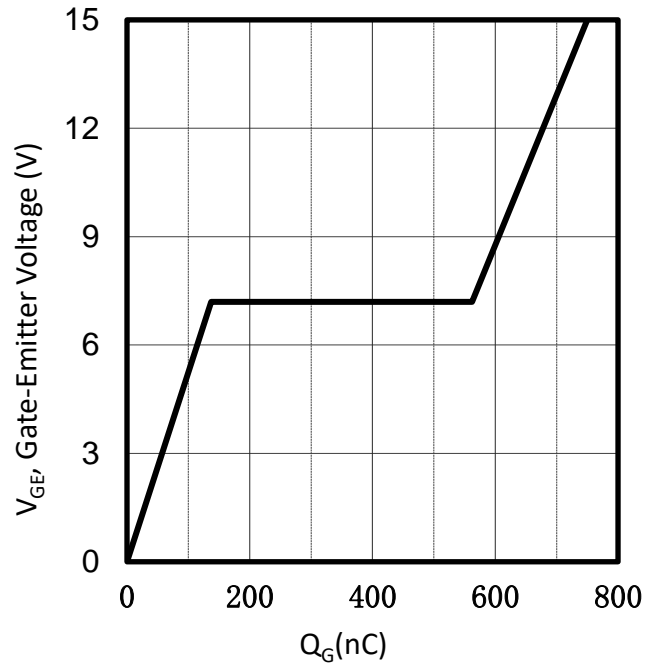

Figure 14. Typical gate charge ( $V_{CE}=600V$ )

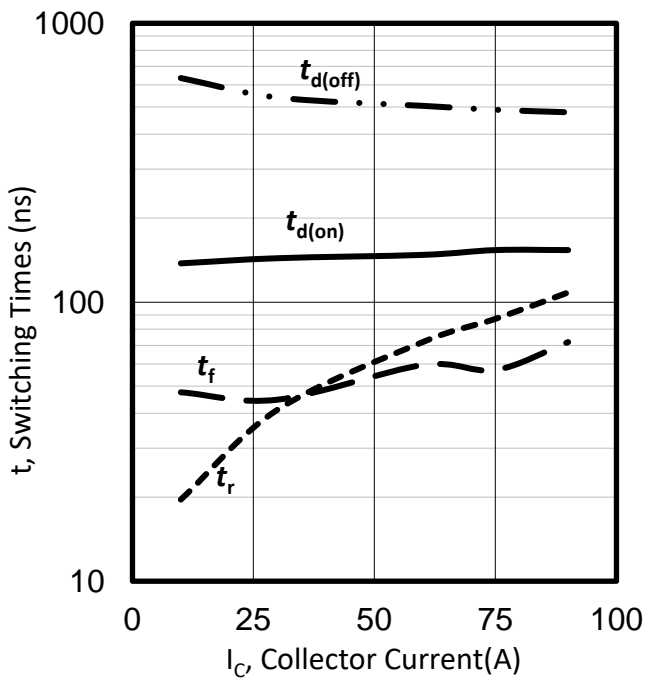

Figure 15. Typical switching times as a function of collector current (inductive load,  $T_{vj}=25^{\circ}C, V_{CE}=600V, V_{GE}=0/15V, R_G=10\Omega$ )

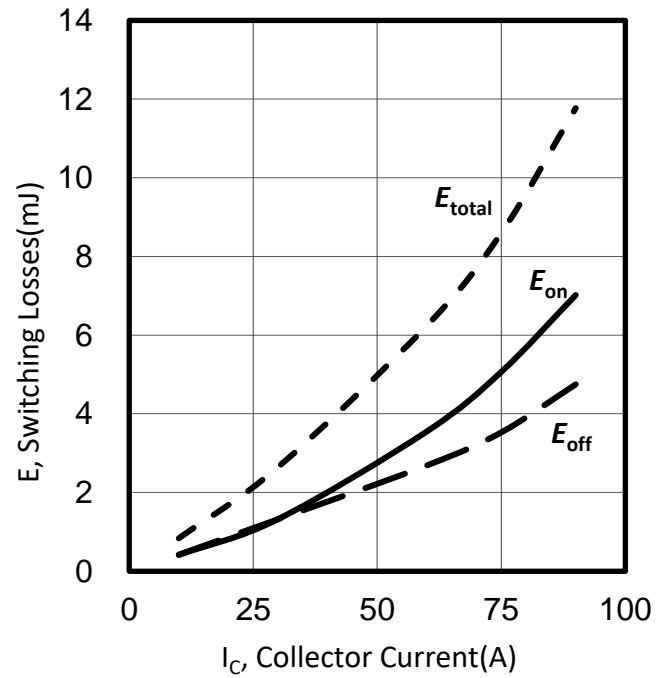
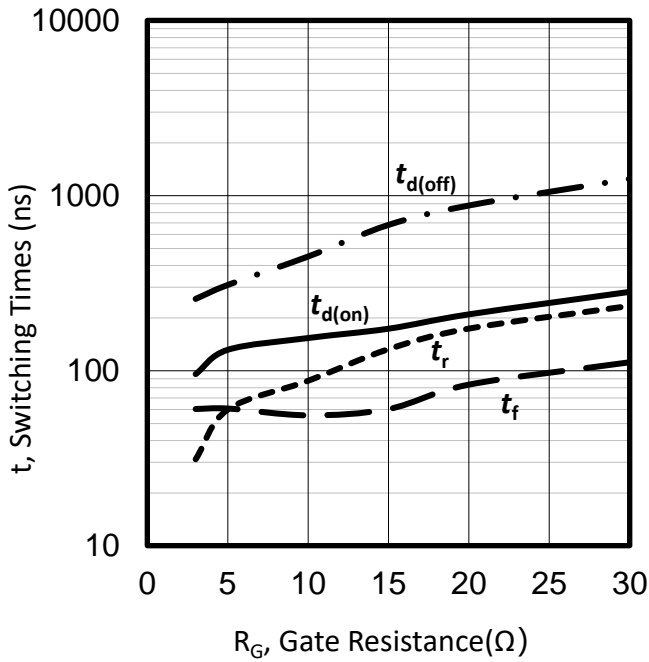
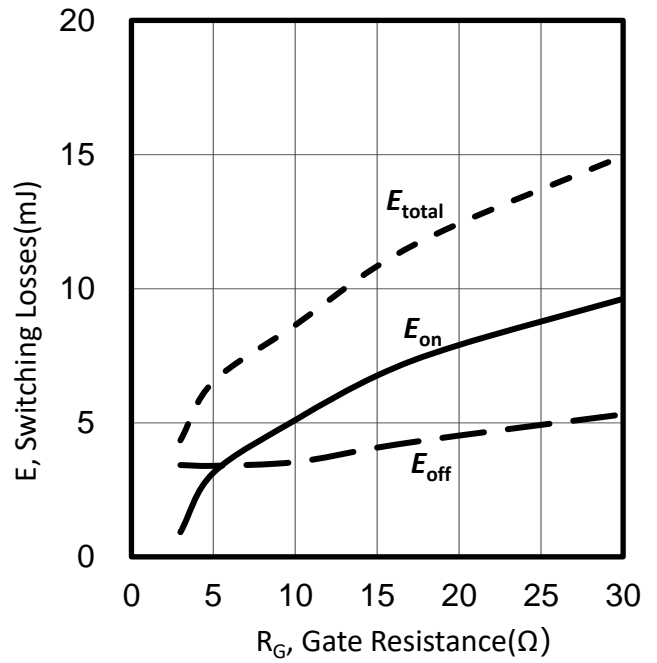

Figure 16. Typical switching times as a function of collector current (inductive load,  $T_{vj}=25^{\circ}C, V_{CE}=600V, V_{GE}=0/15V, R_G=10\Omega$ )



**Figure 17. Typical switching times as a function of gate resistor**  
 (inductive load,  $T_{vj}=25^{\circ}\text{C}$ ,  
 $V_{CE}=600\text{V}$ ,  $V_{GE}=0/15\text{V}$ ,  $I_C=75\text{A}$ )



**Figure 18. Typical switching energy losses as a function of gate resistor**  
 (inductive load,  $T_{vj}=25^{\circ}\text{C}$ ,  
 $V_{CE}=600\text{V}$ ,  $V_{GE}=0/15\text{V}$ ,  $I_C=75\text{A}$ )

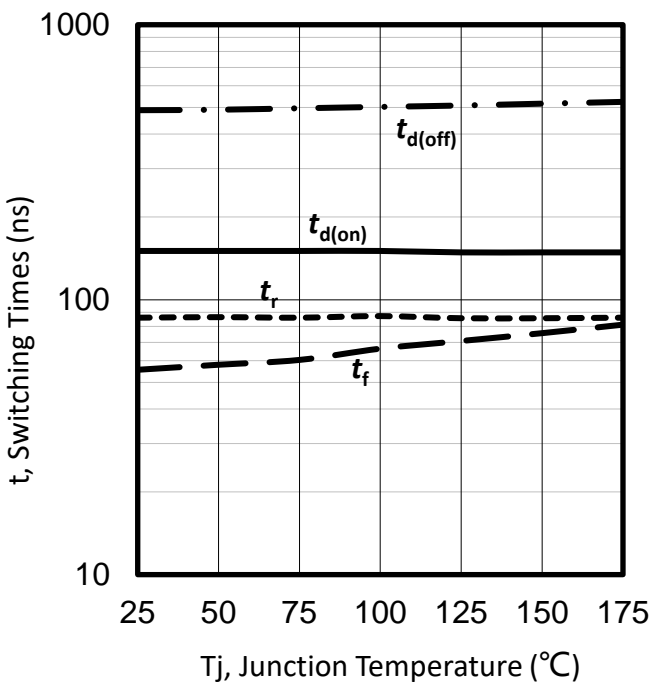

**Figure 19. Typical switching times as a function of junction temperature**  
 (inductive load,  $V_{CE}=600\text{V}$ ,  $V_{GE}=0/15\text{V}$ ,  
 $I_C=75\text{A}$ ,  $R_G=10\Omega$ )

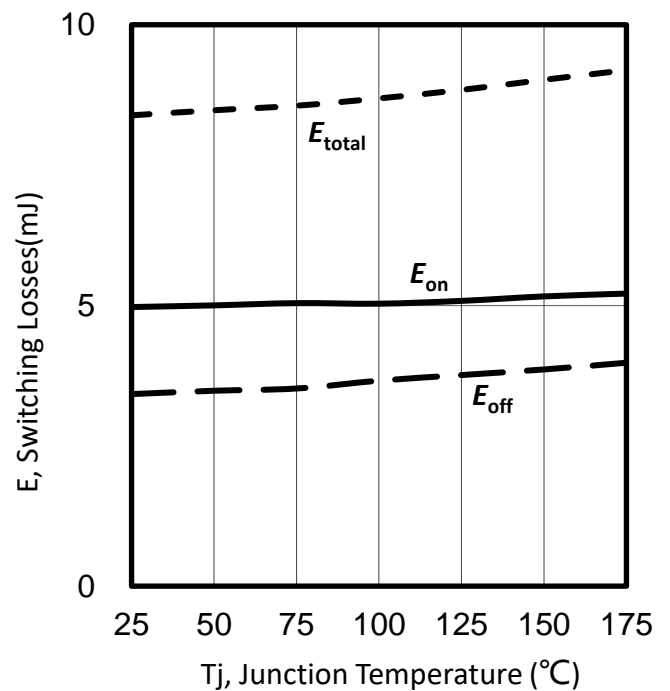

**Figure 20. Typical switching energy losses as a function of junction temperature**  
 (inductive load,  $V_{CE}=600\text{V}$ ,  $V_{GE}=0/15\text{V}$ ,  
 $I_C=75\text{A}$ ,  $R_G=10\Omega$ )



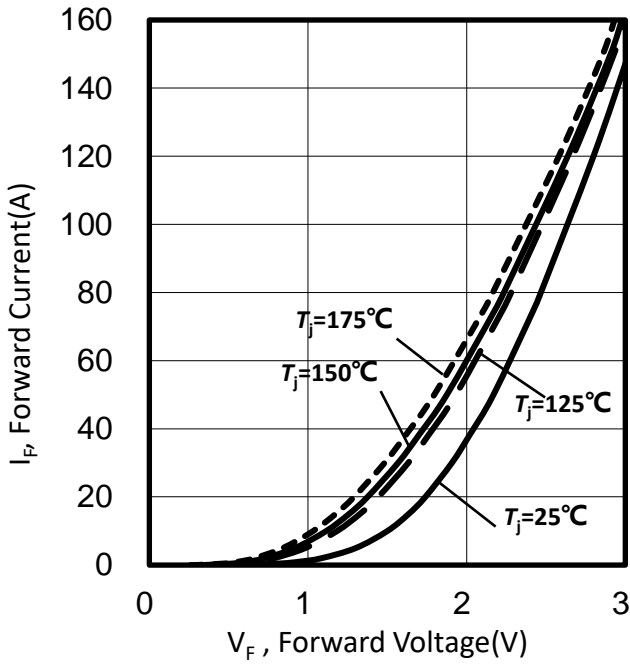

Figure 21. Typical diode forward current as a function of forward voltage

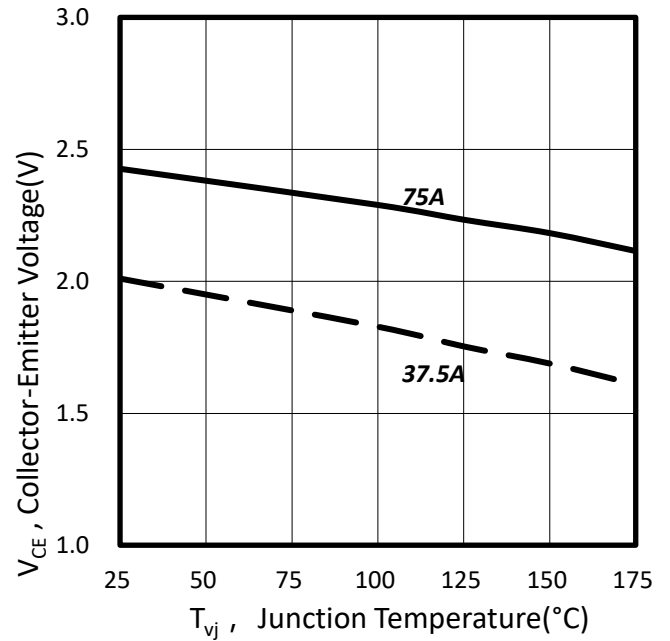

Figure 22. Typical diode forward voltage as a function of junction temperature

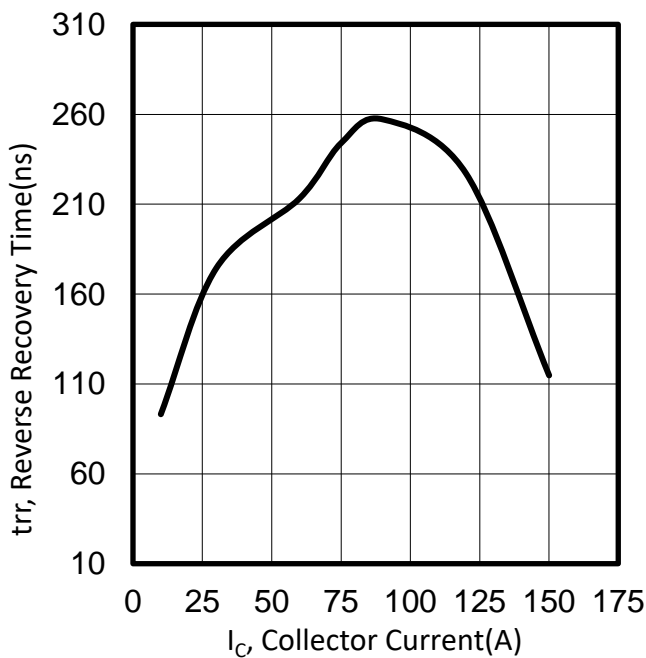

Figure 23. Typical reverse recovery time as a function of collector current  
(inductive load,  $T_{vj}=25^{\circ}\text{C}$   
 $V_{CE}=600\text{V}$ ,  $V_{GE}=0/15\text{V}$ ,  $R_G=10\Omega$ )

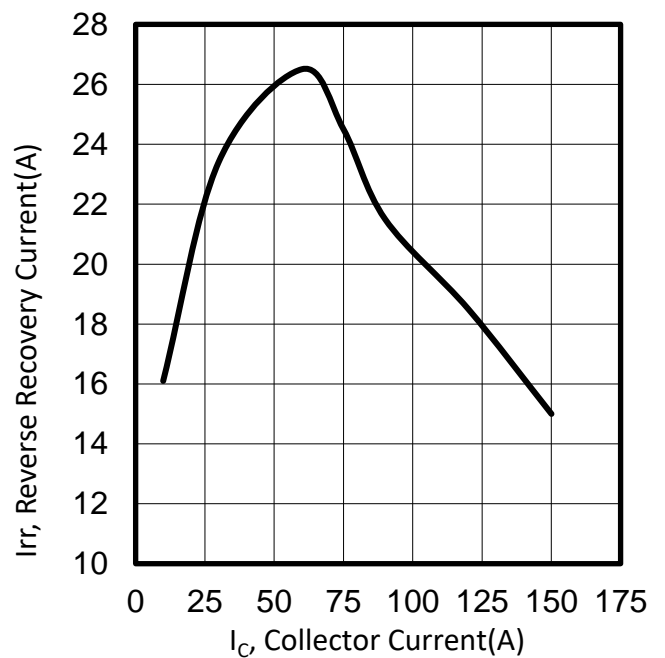
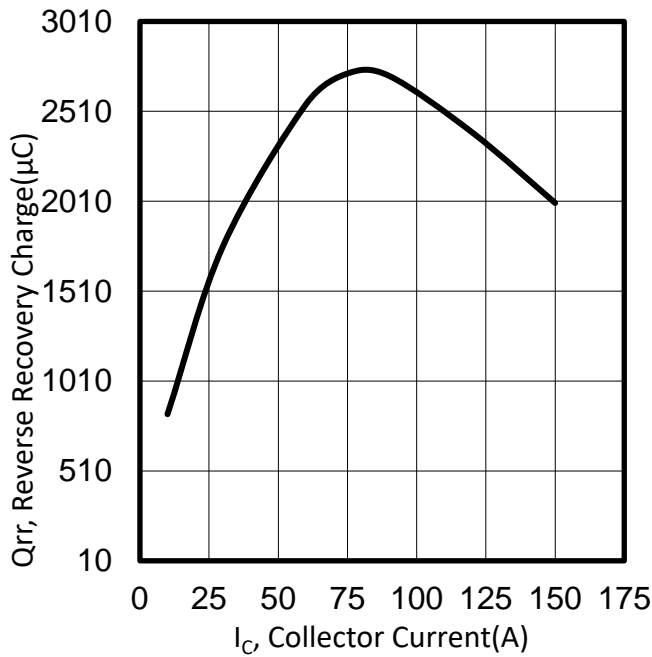
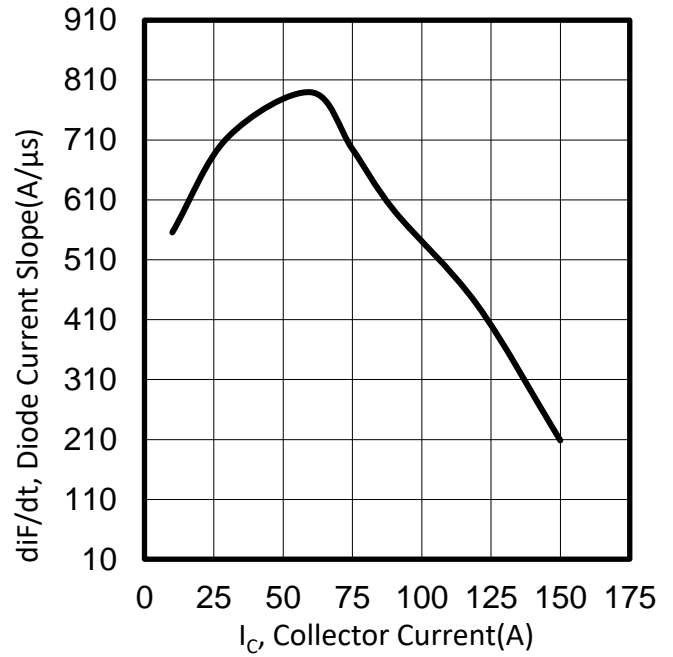

Figure 24. Typical reverse recovery current as a function of collector current  
(inductive load,  $T_{vj}=25^{\circ}\text{C}$   
 $V_{CE}=600\text{V}$ ,  $V_{GE}=0/15\text{V}$ ,  $R_G=10\Omega$ )



**Figure 25. Typical reverse recovery charge as a function of collector current**  
 (inductive load,  $T_{vj}=25^{\circ}\text{C}$   
 $V_{CE}=600\text{V}$ ,  $V_{GE}=0/15\text{V}$ ,  $R_G=10\Omega$ )



**Figure 26. Typical diode current slope as a function of collector current**  
 (inductive load,  $T_{vj}=25^{\circ}\text{C}$   
 $V_{CE}=600\text{V}$ ,  $V_{GE}=0/15\text{V}$ ,  $R_G=10\Omega$ )

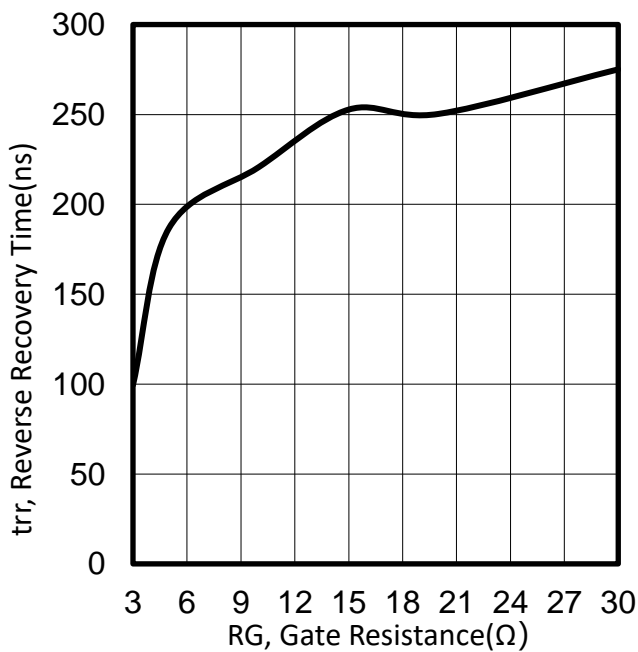

**Figure 27. Typical reverse recovery time as a function of gate resistor**  
 (inductive load,  $T_{vj}=25^{\circ}\text{C}$   
 $V_{CE}=600\text{V}$ ,  $V_{GE}=0/15\text{V}$ ,  $I_C=75\text{A}$ )

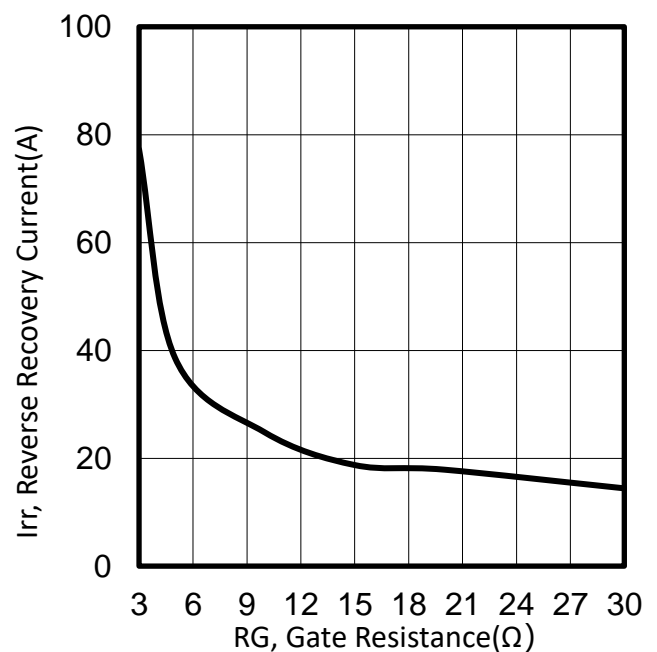

**Figure 28. Typical reverse recovery current as a function of gate resistor**  
 (inductive load,  $T_{vj}=25^{\circ}\text{C}$   
 $V_{CE}=600\text{V}$ ,  $V_{GE}=0/15\text{V}$ ,  $I_C=75\text{A}$ )

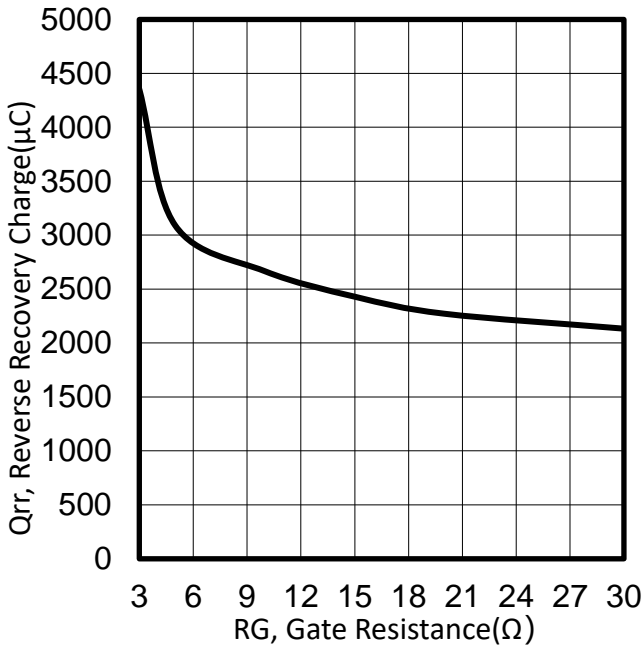

**Figure 29. Typical reverse recovery charge as a function of gate resistor**  
 (inductive load,  $T_{vj}=25^{\circ}\text{C}$   
 $V_{CE}=600\text{V}$ ,  $V_{GE}=0/15\text{V}$ ,  $I_C=75\text{A}$ )

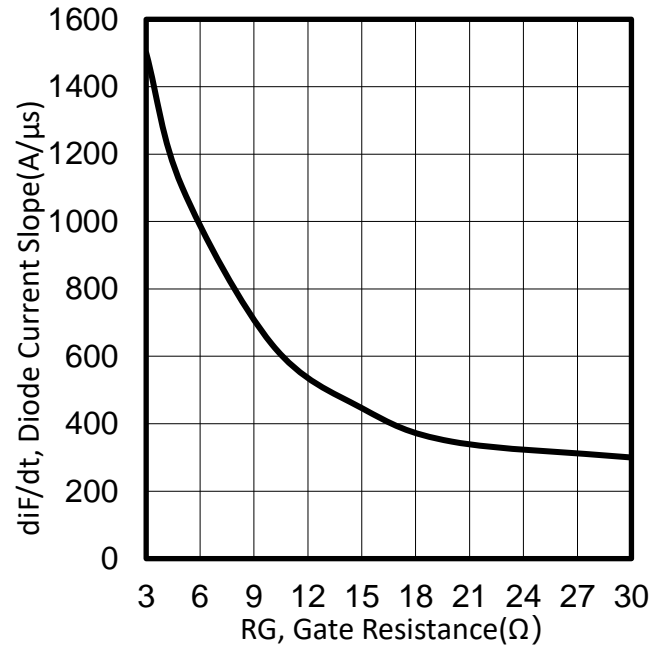

**Figure 30. Typical diode current slope as a function of gate resistor**  
 (inductive load,  $T_{vj}=25^{\circ}\text{C}$   
 $V_{CE}=600\text{V}$ ,  $V_{GE}=0/15\text{V}$ ,  $I_C=75\text{A}$ )

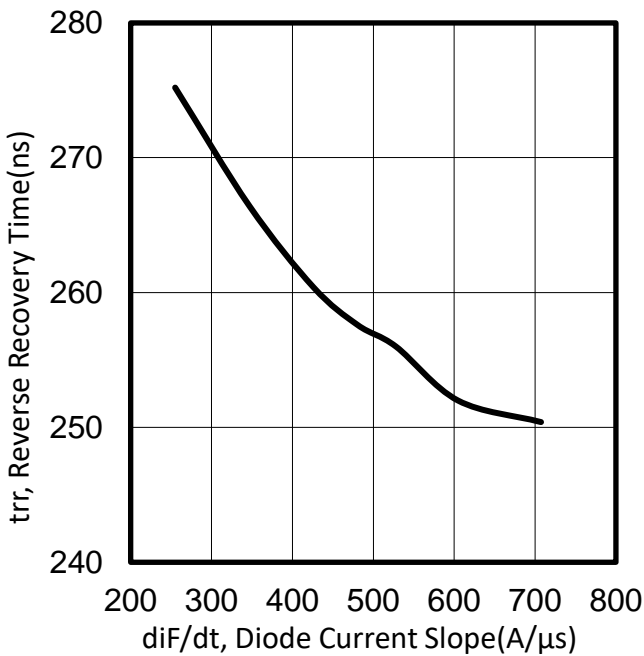

**Figure 31. Typical reverse recovery time as a function of diode current slope**  
 ( $V_R=600\text{V}$ ,  $I_F=75\text{A}$ ,  $T_{vj}=25^{\circ}\text{C}$ )

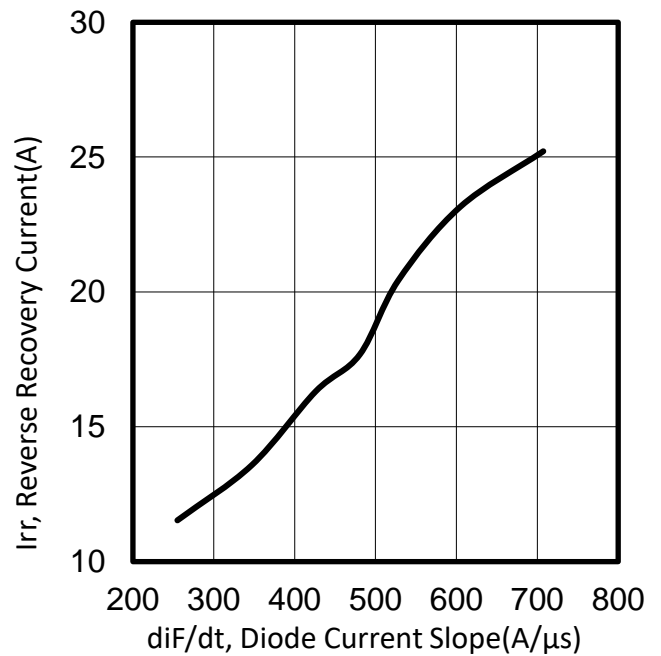

**Figure 32. Typical reverse recovery current as a function of diode current slope**  
 ( $V_R=600\text{V}$ ,  $I_F=75\text{A}$ ,  $T_{vj}=25^{\circ}\text{C}$ )

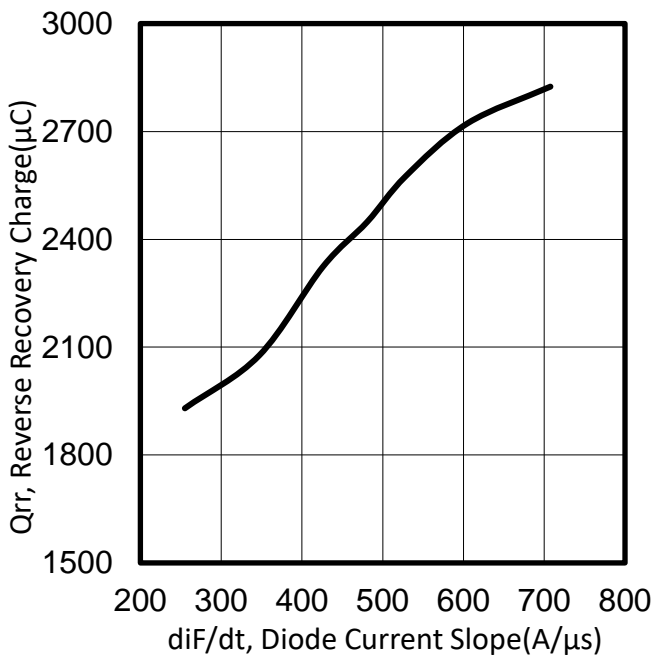

**Figure 33. Typical reverse recovery charge as a function of diode current slope**  
 ( $V_R=600V, I_F=75A, T_{vj}=25^{\circ}C$ )

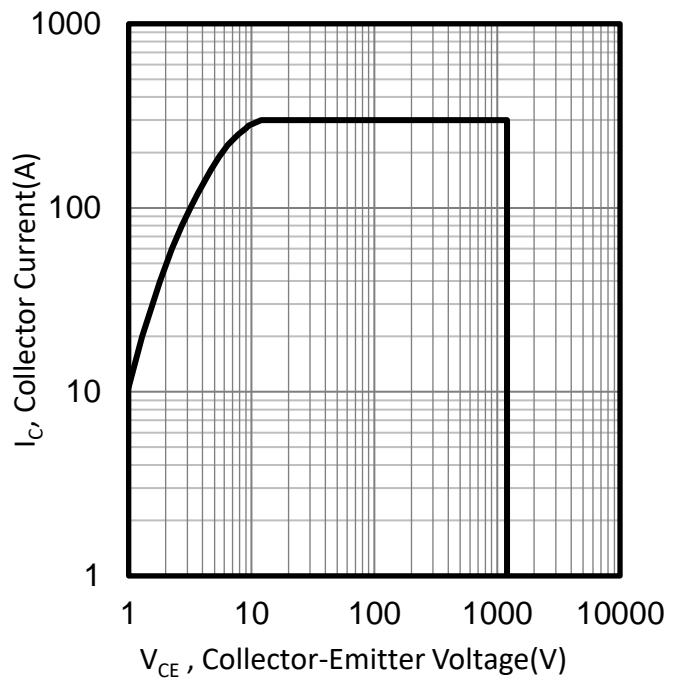

**Figure 34. IGBT reverse bias safe operating area**  
 ( $T_{vj} \leq 175^{\circ}C, V_{GE}=15V$ )

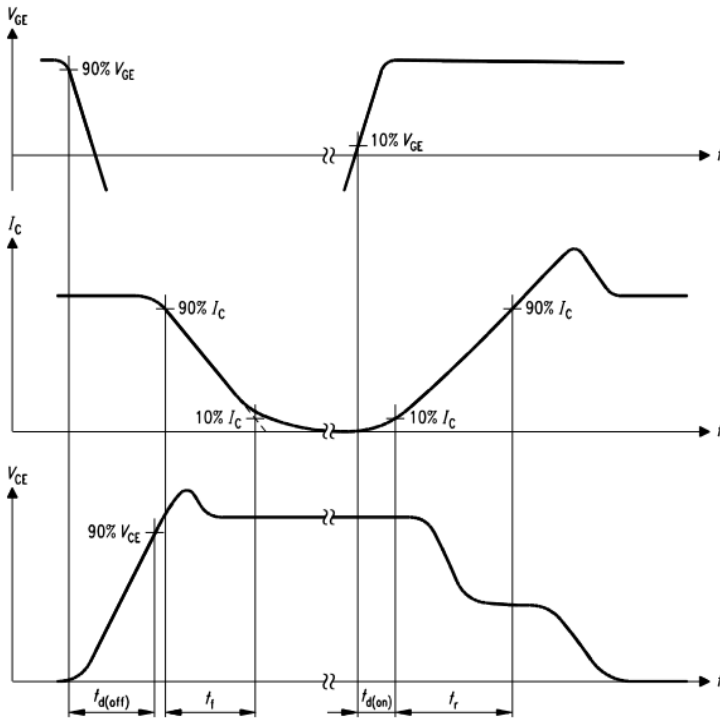

Figure A. Definition of switching times

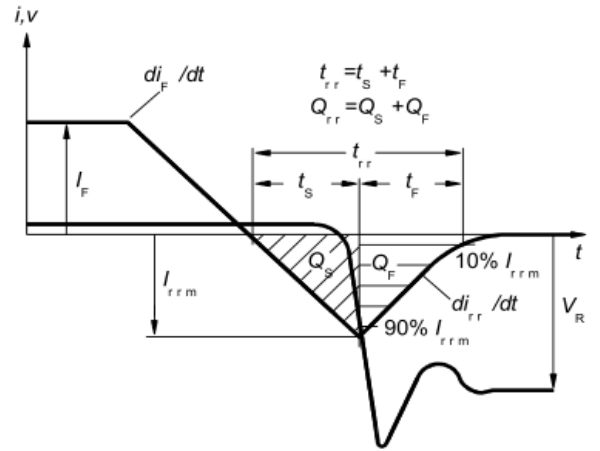

Figure C. Definition of diodes switching characteristics

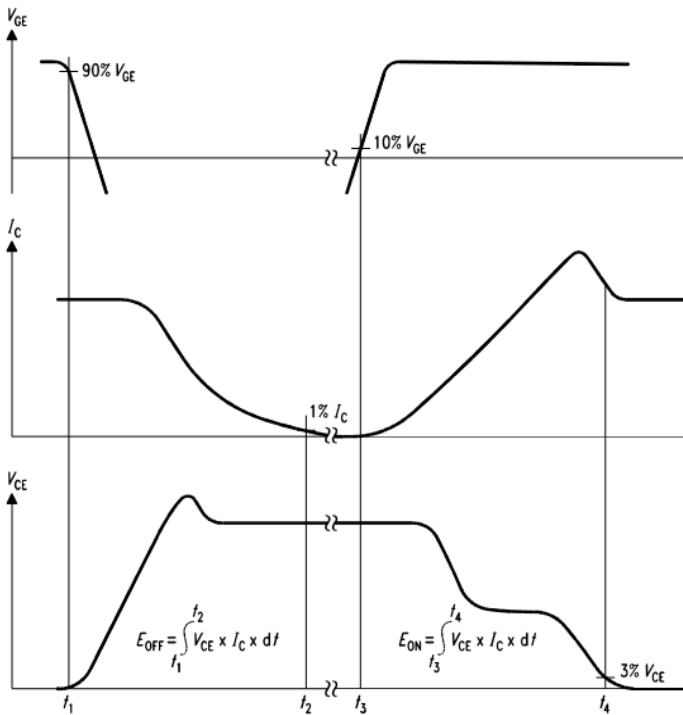

Figure B. Definition of switching losses

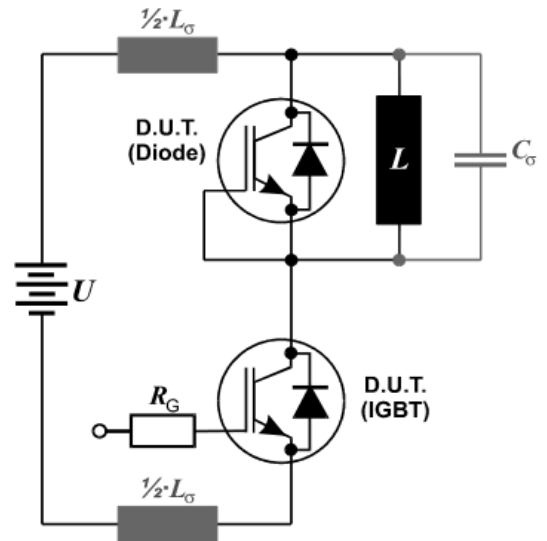
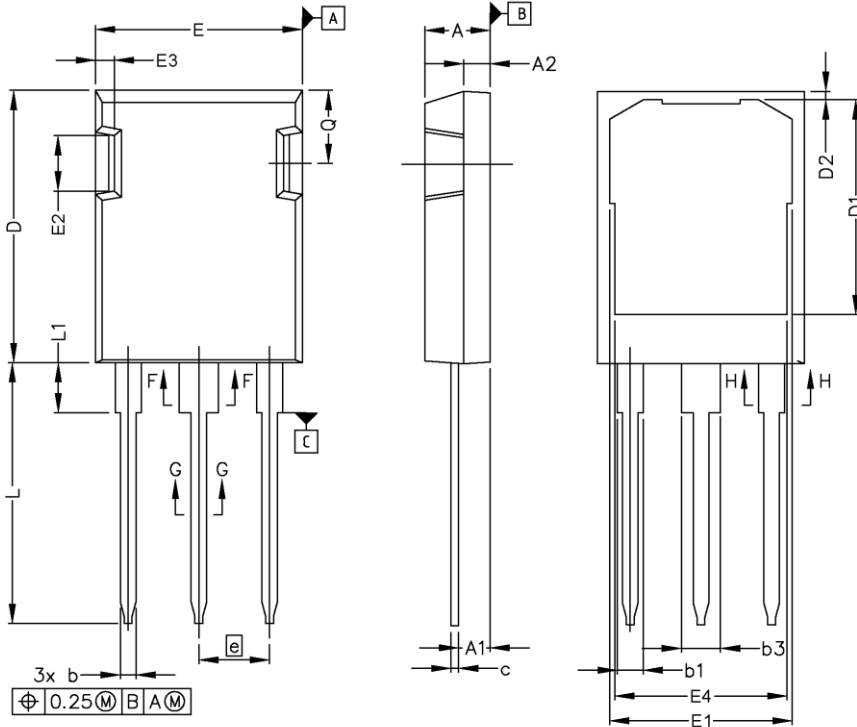

Figure D. Switching test circuit

# TO-247-3L Plus



SYMBOL	MIN	MAX
A	4.83	5.21
A1	2.29	2.54
A2	1.91	2.16
b'	1.07	1.28
b	1.07	1.33
b1	1.91	2.41
b2	1.91	2.16
b3	2.87	3.38
b4	2.87	3.13
c'	0.55	0.65
c	0.55	0.68
D	20.80	21.10
D1	16.25	17.65
D2	0.50	0.80
E	15.75	16.13
E1	13.10	14.15
E2	3.68	5.10
E3	1.00	1.90
E4	12.38	13.43
e	5.44 BSC	
N	3	
L	19.81	20.32
L1	3.70	4.00
Q	5.49	6.00

NOTE:  
 1. ALL METAL SURFACES, TIN PLATED, EXCEPT AREA OF CUT  
 2. DIMENSIONING & TOLERANCING CONFIRM TO ASME Y14.5M-1994  
 3. ALL DIMENSIONS ARE IN MILLIMETERS. ANGLES ARE IN DEGREES.  
 4. THIS DRAWING WILL MEET ALL DIMENSIONS REQUIREMENT OF JEDEC outlines TO-247 AD.

- 1 - GATE
- 2 - DRAIN (COLLECTOR)
- 3 - SOURCE (EMITTER)
- 4 - DRAIN (COLLECTOR)

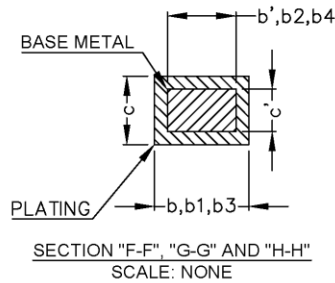



## Revision History

Revision	Subjects (major changes since last revision)	Date
1.0	Initial version	2022.5

## Terms & Conditions of usage

1. The product specifications, characteristics, data, materials and structures given in this datasheet are subject to change without notice.
2. The information given in this datasheet shall in no event be regarded as a guarantee of conditions or characteristics. Marching-Power Technology Co., Ltd. does not warrant or assume any legal liability or responsibility for the accuracy and completeness of any examples, hints or any typical values stated herein and/or any information regarding the application of the product.
3. This datasheet is only used as a reference for customers to apply our products, Marching-Power Technology Co., Ltd. does not undertake to permit the use of intellectual property rights or any third-party property rights related to the product information described in this datasheet.
4. Although Marching-Power Technology Co., Ltd. is committed to enhancing product quality and reliability, all semiconductor products still have a probability of failure. When using Marching-Power semiconductor products in your equipment, you are requested to take adequate safety measures to prevent the equipment from causing accidents or events including but not limited to physical injury, fire or damage to other property if any of the products become faulty.
5. The products introduced in this datasheet are electrostatic sensitive devices and must be protected against static electricity during device installation, testing, packaging, storage and transportation.
6. Do not use the products introduced in this datasheet in equipment or systems that requiring strict reliability or/and may directly endanger human life such as medical, life-saving, life-sustaining, space equipment, aeronautic equipment, nuclear equipment submarine repeater equipment and equivalents to strategic equipment (without limitation).
7. No part of this datasheet may be disseminated and reproduced in any form or by any means without prior written permission from Marching-Power Technology Co., Ltd.
8. The data contained in this datasheet is exclusively intended for use by professional technicians only. It is the responsibility of the customer's own technical departments to evaluate the suitability of the product for the intended application and the completeness of the product information given in this document with respect to corresponding application. If you have any question about any portion in this datasheet, contact Marching-Power Technology Co., Ltd. before using the product. Marching-Power Technology Co., Ltd. shall not be liable for any injury caused by any use of the products not in accordance with instructions set forth herein.

单击下面可查看定价，库存，交付和生命周期等信息

[>>芯长征](#)