

KEMET, L-SMS, Commercial Grade, 680 nH, 20%

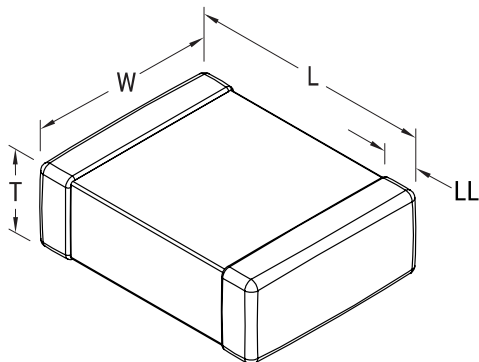

General Information	
Series:	L-SMS
Style:	SMD Chip
Description:	Shielded, Surface Mount Inductor
Features:	Standard Type
RoHS:	Yes
Core:	Ceramic
Winding Type:	Multilayer

Dimensions	
Chip Size	0603
L	1.6mm +/-0.15mm
W	0.8mm +/-0.15mm
T	0.8mm +/-0.15mm
LL	0.3mm +/-0.2mm

Specifications	
Inductance:	0.68 uH (25 MHz)
Inductance Tolerance:	20%
Temperature Range:	-40/+85°C
Current:	35 mAmps (MAX)
DC Resistance:	1.7 Ohms
Quality Factor:	15 at 25 MHz
Self-Resonant Frequency:	80 MHz

Packaging Specifications	
Packaging:	T&R
Packaging Quantity:	4000

Statements of suitability for certain applications are based on our knowledge of typical operating conditions for such applications, but are not intended to constitute - and we specifically disclaim - any warranty concerning suitability for a specific customer application or use. This Information is intended for use only by customers who have the requisite experience and capability to determine the correct products for their application. Any technical advice inferred from this Information or otherwise provided by us with reference to the use of our products is given gratis, and we assume no obligation or liability for the advice given or results obtained.

单击下面可查看定价，库存，交付和生命周期等信息

[>>KEMET Electronics\(基美\)](#)