

KEMET, L-SMS, Commercial Grade, 8200 nH, 10%

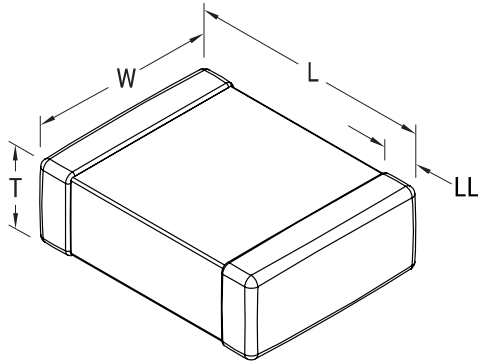

Dimensions	
Chip Size	0603
L	1.6mm +/-0.15mm
W	0.8mm +/-0.15mm
T	0.8mm +/-0.15mm
LL	0.3mm +/-0.2mm

Packaging Specifications	
Packaging:	T&R
Packaging Quantity:	4000

General Information	
Series:	L-SMS
Style:	SMD Chip
Description:	Shielded, Surface Mount Inductor
Features:	Standard Type
RoHS:	Yes
Core:	Ceramic
Winding Type:	Multilayer

Specifications	
Inductance:	8.2 uH (4 MHz)
Inductance Tolerance:	10%
Temperature Range:	-40/+85°C
Current:	5 mAmps (MAX)
DC Resistance:	2.1 Ohms
Quality Factor:	35 at 4 MHz
Self-Resonant Frequency:	18 MHz

单击下面可查看定价，库存，交付和生命周期等信息

[>>KEMET Electronics\(基美\)](#)