

KEMET Part Number: PFR5471H100J11L16.5TA16
(F411JH471H100Q)

PFR/F411, Film, Film/Foil Polypropylene, 470 pF, 2.5%, 100 VDC, 85°C, Lead Spacing = 5mm

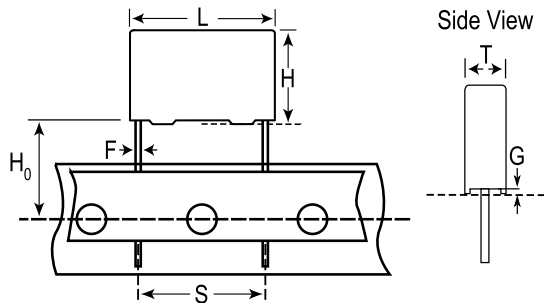

General Information	
Series:	PFR/F411
Dielectric:	Film/Foil Polypropylene
Style:	Radial
Features:	Pulse
RoHS:	Yes
Lead:	Wire Leads
Miscellaneous:	An Operating Temperature Up To +105C Is Allowed Under Certain Conditions. Please Consult KEMET For Details.

Dimensions	
L	7.2mm MAX
H	6mm MAX
T	4.5mm MAX
S	5mm +0.6/-0.1mm
H0	16mm +/-0.5mm
F	0.5mm +/-0.05mm
G	0.5mm NOM

Specifications	
Capacitance:	470 pF
Capacitance Tolerance:	2.5%
Voltage AC:	63 VAC
Voltage DC:	100 VDC
Temperature Range:	-55/+100C
Rated Temperature:	85°C
Dissipation Factor:	0.04% 1kHz, 0.04% 10kHz, 0.05% 100kHz
Insulation Resistance:	63829.7872 GOhms
Max dV/dt:	1000 V/us
Inductance:	6 nH

Packaging Specifications	
Packaging:	Ammo, 330x330x50mm, Box
Packaging Quantity:	1700

Statements of suitability for certain applications are based on our knowledge of typical operating conditions for such applications, but are not intended to constitute - and we specifically disclaim - any warranty concerning suitability for a specific customer application or use. This Information is intended for use only by customers who have the requisite experience and capability to determine the correct products for their application. Any technical advice inferred from this Information or otherwise provided by us with reference to the use of our products is given gratis, and we assume no obligation or liability for the advice given or results obtained.

单击下面可查看定价，库存，交付和生命周期等信息

[>>KEMET Electronics\(基美\)](#)