

KEMET, L-SMS, Commercial Grade, 1200 nH, 20%

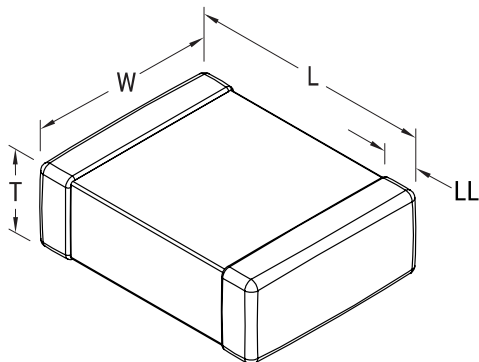

Dimensions	
Chip Size	0805
L	2mm +0.3/-0.1mm
W	1.25mm +/-0.2mm
T	0.85mm +/-0.2mm
LL	0.5mm +/-0.2mm

Packaging Specifications	
Packaging:	T&R
Packaging Quantity:	4000

General Information	
Series:	L-SMS
Style:	SMD Chip
Description:	Shielded, Surface Mount Inductor
Features:	Standard Type
RoHS:	Yes
Core:	Ceramic
Winding Type:	Multilayer

Specifications	
Inductance:	1.2 uH (10 MHz)
Inductance Tolerance:	20%
Temperature Range:	-40/+85°C
Current:	50 mAmps (MAX)
DC Resistance:	0.5 Ohms
Quality Factor:	45 at 10 MHz
Self-Resonant Frequency:	65 MHz

单击下面可查看定价，库存，交付和生命周期等信息

[>>KEMET Electronics\(基美\)](#)