

PEG126, Aluminum Electrolytic, 250 uF, -10/+30%, 63 VDC, -40/+150°C

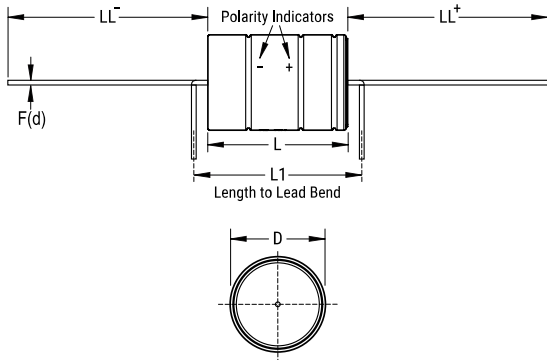

Note: '()' correspond to the letters used in the product bulletin

Dimensions	
D	16mm +/-0.5mm
L	29mm +/-1mm
L1	35mm MIN
LL Negative	42mm +3/-2mm
LL Positive	42mm +3/-2mm
F	1mm +/-0.03mm

Packaging Specifications	
Weight:	8 g
Packaging:	Bulk, Bag
Packaging Quantity:	125

General Information	
Series:	PEG126
Dielectric:	Aluminum Electrolytic
Style:	Axial
Description:	Vibration Resistant High Ripple Axial Aluminum Electrolytic
Features:	Vibration Resistant, High Ripple
RoHS:	Yes
Lead:	Wire Leads
Qualifications:	AEC-Q200
AEC-Q200:	Yes
Miscellaneous:	Note: The Voltage, Life , And Rated Ripple Current Displayed For This Series Is Measured At 125C Instead Of 150C
Notes:	L1 is KEMETs recommendation for minimum distance between symmetrical Lead bend. Available only for Customer specific part numbers. Lead bend dimensions must be specified and confirmed per article.
Shelf Life:	156 Weeks

Specifications	
Capacitance:	250 uF
Capacitance Tolerance:	-10/+30%
Voltage DC:	63 VDC
Temperature Range:	-40/+150°C
Rated Temperature:	150°C
Life:	6300 Hrs (125C), 1500 Hrs (150C)
Resistance:	240 mOhms (100Hz 20C), 53 mOhms (100kHz 20C)
Ripple Current:	0.9 Amps (100Hz 125C), 5.3 Amps (5kHz 105C), 3.1 Amps (5kHz 125C), 1.2 Amps (5kHz 150C)
Leakage Current:	47 uA (5min 20°C)
Inductance:	10 nH (ESL)

Statements of suitability for certain applications are based on our knowledge of typical operating conditions for such applications, but are not intended to constitute - and we specifically disclaim - any warranty concerning suitability for a specific customer application or use. This Information is intended for use only by customers who have the requisite experience and capability to determine the correct products for their application. Any technical advice inferred from this Information or otherwise provided by us with reference to the use of our products is given gratis, and we assume no obligation or liability for the advice given or results obtained.

单击下面可查看定价，库存，交付和生命周期等信息

[>>KEMET Electronics\(基美\)](#)