

PEG126, Aluminum Electrolytic, 2,700 uF, -10/+30%, 40 VDC, -40/+150°C

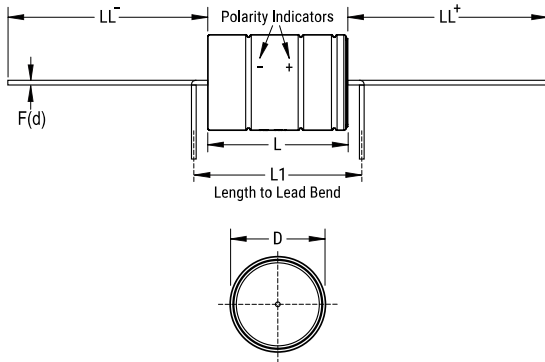

Note: '()' correspond to the letters used in the product bulletin

Dimensions	
D	20mm +/-0.5mm
L	46mm +/-1mm
L1	52mm MIN
LL Negative	42mm +3/-2mm
LL Positive	42mm +3/-2mm
F	1mm +/-0.03mm

Packaging Specifications	
Weight:	24 g
Packaging:	Bulk, Bag
Packaging Quantity:	100

General Information	
Series:	PEG126
Dielectric:	Aluminum Electrolytic
Style:	Axial
Description:	Vibration Resistant High Ripple Axial Aluminum Electrolytic
Features:	Vibration Resistant, High Ripple
RoHS:	Yes
Lead:	Wire Leads
Qualifications:	AEC-Q200
AEC-Q200:	Yes
Miscellaneous:	Note: The Voltage, Life , And Rated Ripple Current Displayed For This Series Is Measured At 125C Instead Of 150C
Notes:	L1 is KEMETs recommendation for minimum distance between symmetrical Lead bend. Available only for Customer specific part numbers. Lead bend dimensions must be specified and confirmed per article.
Shelf Life:	156 Weeks

Specifications	
Capacitance:	2,700 uF
Capacitance Tolerance:	-10/+30%
Voltage DC:	40 VDC
Temperature Range:	-40/+150°C
Rated Temperature:	150°C
Life:	8400 Hrs (125C), 2000 Hrs (150C)
Resistance:	37 mOhms (100Hz 20C), 17 mOhms (100kHz 20C)
Ripple Current:	3.1 Amps (100Hz 125C), 12.1 Amps (5kHz 105C), 7.1 Amps (5kHz 125C), 2.7 Amps (5kHz 150C)
Leakage Current:	324 uA (5min 20°C)
Inductance:	17 nH (ESL)

单击下面可查看定价，库存，交付和生命周期等信息

[>>KEMET Electronics\(基美\)](#)