

KEMET, L-RMS, RF, 1200 pH, +/-0.3 nH

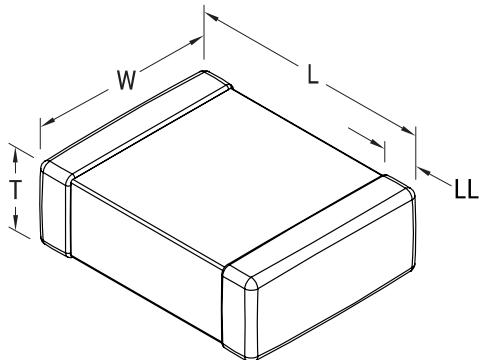

Dimensions	
Chip Size	0603
L	1.6mm +/-0.15mm
W	0.8mm +/-0.15mm
T	0.8mm +/-0.15mm
LL	0.3mm +/-0.2mm

Packaging Specifications	
Packaging:	T&R
Packaging Quantity:	4000

General Information	
Series:	L-RMS
Style:	SMD Chip
Description:	Surface Mount Inductor
RoHS:	Yes
Core:	Ceramic
Winding Type:	Multilayer

Specifications	
Inductance:	0.0012 uH (100 MHz)
Inductance Tolerance:	+/-0.3 nH
Temperature Range:	-40/+85°C
Current:	300 mAmps (MAX)
DC Resistance:	0.05 Ohms
Quality Factor:	14 at 100 MHz, 40 at 500 MHz, 70 at 800 MHz, 90 at 1000 MHz
Self-Resonant Frequency:	10000 MHz

单击下面可查看定价，库存，交付和生命周期等信息

[>>KEMET\(基美\)](#)