

KEMET Part Number: ERP610W471KERU
(C831ER471K760J, ERP610VH3470KERU)

ERP610 SFTY X1-760 Y1-500, Ceramic, 470 pF, 10%, 760 VAC (X1), 500 VAC (Y1), Y5U, Lead Spacing = 12.5mm

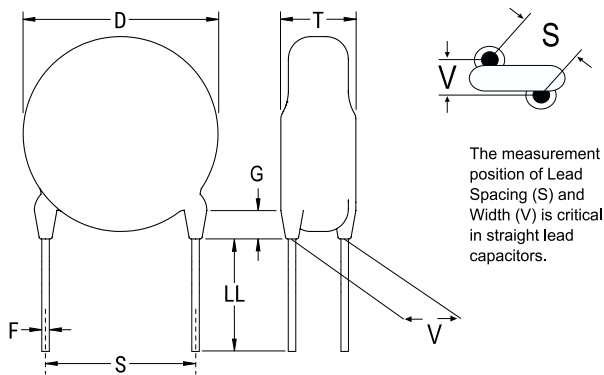

The measurement position of Lead Spacing (S) and Width (V) is critical in straight lead capacitors.

General Information	
Series:	ERP610 SFTY X1-760 Y1-500
Style:	Radial Disc
Description:	Ceramic Single Layer Safety Disc Capacitors
RoHS:	Yes
Termination:	Tin
Qualifications:	UL, CSA, CAN, ENEC, VDE
Notes:	Please See Bulletin For Taping Information. H Dimension Refers to Seating Plane To Center Hole of Tape

Dimensions	
D	8mm MAX
H	18mm +2mm
T	5mm MAX
S	12.5mm +/-0.8mm
F	0.6mm +/-0.05mm
G	3mm MAX
V	2.1mm +/-0.5mm

Specifications	
Capacitance:	470 pF
Capacitance Tolerance:	10%
Voltage AC:	760 VAC (X1), 500 VAC (Y1)
Temperature Range:	-40/+125°C
Temperature Coefficient:	Y5U
Dissipation Factor:	2.50%
Insulation Resistance:	10 GOhms
Safety Class:	X1/Y1

Packaging Specifications	
Packaging:	T&R, H = 18mm, Component Pitch = 25.4mm

Statements of suitability for certain applications are based on our knowledge of typical operating conditions for such applications, but are not intended to constitute - and we specifically disclaim - any warranty concerning suitability for a specific customer application or use. This Information is intended for use only by customers who have the requisite experience and capability to determine the correct products for their application. Any technical advice inferred from this Information or otherwise provided by us with reference to the use of our products is given gratis, and we assume no obligation or liability for the advice given or results obtained.

单击下面可查看定价，库存，交付和生命周期等信息

[>>KEMET\(基美\)](#)