

KEMET Part Number: PFR5472H100J12L16.5TA16
(F411JK472H100Q)

PFR/F411, Film, Film/Foil Polypropylene, 4700 pF, 2.5%, 100 VDC, 85°C, Lead Spacing = 5mm

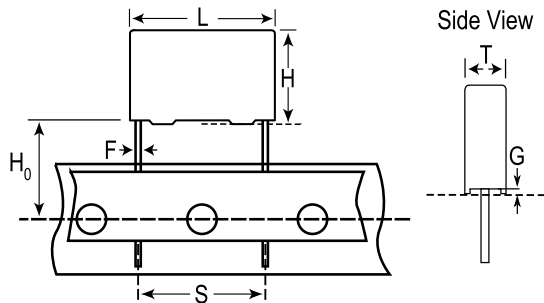

General Information	
Series:	PFR/F411
Dielectric:	Film/Foil Polypropylene
Style:	Radial
Features:	Pulse
RoHS:	Yes
Lead:	Wire Leads
Miscellaneous:	An Operating Temperature Up To +105C Is Allowed Under Certain Conditions. Please Consult KEMET For Details.

Dimensions	
L	7.2mm MAX
H	7mm MAX
T	5.5mm MAX
S	5mm +0.6/-0.1mm
H0	16mm +/-0.5mm
F	0.5mm +/-0.05mm
G	0.5mm NOM

Specifications	
Capacitance:	4700 pF
Capacitance Tolerance:	2.5%
Voltage AC:	63 VAC
Voltage DC:	100 VDC
Temperature Range:	-55/+100C
Rated Temperature:	85°C
Dissipation Factor:	0.04% 1kHz, 0.05% 10kHz, 0.07% 100kHz
Insulation Resistance:	6382.9787 GOhms
Max dV/dt:	1000 V/us
Inductance:	6 nH

Packaging Specifications	
Packaging:	Ammo, 330x330x50mm, Box
Packaging Quantity:	1300

单击下面可查看定价，库存，交付和生命周期等信息

[>>KEMET\(基美\)](#)