

KEMET Part Number: ERP610W681MEF0
(C831EF681M760A, ERP610VH3680MEF0)

ERP610 SFTY X1-760 Y1-500, Ceramic, 680 pF, 20%, 760 VAC (X1), 500 VAC (Y1), Y5U, Lead Spacing = 12.5mm

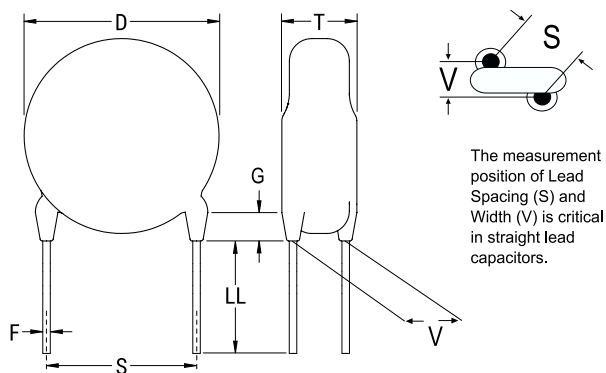

Dimensions

D	8mm MAX
T	5mm MAX
S	12.5mm NOM
LL	30mm -3mm
F	0.6mm +/-0.05mm
G	3mm MAX
V	2.1mm +/-0.5mm

Packaging Specifications

Packaging:	Bulk, Bag
-------------------	-----------

General Information

Series:	ERP610 SFTY X1-760 Y1-500
Style:	Radial Disc
Description:	Ceramic Single Layer Safety Disc Capacitors
RoHS:	Yes
Termination:	Tin
Qualifications:	UL, CSA, CAN, ENEC, VDE

Specifications

Capacitance:	680 pF
Capacitance Tolerance:	20%
Voltage AC:	760 VAC (X1), 500 VAC (Y1)
Temperature Range:	-40/+125°C
Temperature Coefficient:	Y5U
Dissipation Factor:	2.50%
Insulation Resistance:	10 GOhms
Safety Class:	X1/Y1

单击下面可查看定价，库存，交付和生命周期等信息

[>>KEMET\(基美\)](#)