

KEMET, L-RMS, RF, 3900 pH, +/-0.3 nH

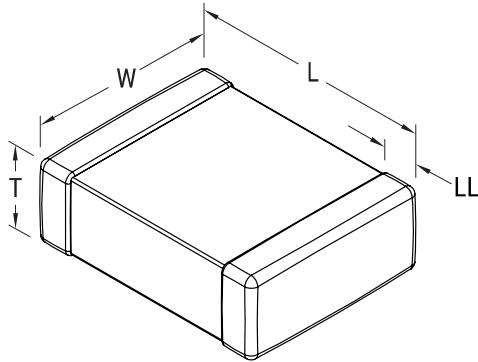

Dimensions	
Chip Size	0201
L	0.6mm +/-0.03mm
W	0.3mm +/-0.03mm
T	0.3mm +/-0.03mm
LL	0.15mm +/-0.05mm

Packaging Specifications	
Packaging:	T&R
Packaging Quantity:	15000

General Information	
Series:	L-RMS
Style:	SMD Chip
Description:	Surface Mount Inductor
RoHS:	Yes
Core:	Ceramic
Winding Type:	Multilayer

Specifications	
Inductance:	0.0039 uH (100 MHz)
Inductance Tolerance:	+/-0.3 nH
Temperature Range:	-55/+125°C
Current:	170 mAmps (MAX)
DC Resistance:	0.3 Ohms
Quality Factor:	7 at 100 MHz, 15 at 500 MHz, 20 at 800 MHz, 22 at 1000 MHz
Self-Resonant Frequency:	6000 MHz

单击下面可查看定价，库存，交付和生命周期等信息

[>>KEMET\(基美\)](#)