

General Description

These P-Channel enhancement mode power field effect transistors are using trench DMOS technology. This advanced technology has been especially tailored to minimize on-state resistance, provide superior switching performance, and withstand high energy pulse in the avalanche and commutation mode. These devices are well suited for high efficiency fast switching applications.

BVDSS	RDSON	ID
-40V	45mΩ	-6.5A

Features

- -40V, -6.5A, $R_{DS(ON)} = 45m\Omega @ V_{GS} = -10V$
- Improved dv/dt capability
- Fast switching
- Green Device Available

SOP8 Pin Configuration



Applications

- Motor Drive
- Power Tools
- LED Lighting

Absolute Maximum Ratings $T_c=25^\circ\text{C}$ unless otherwise noted

Symbol	Parameter	Rating	Units
V_{DS}	Drain-Source Voltage	-40	V
V_{GS}	Gate-Source Voltage	± 20	V
I_D	Drain Current – Continuous ($T_c=25^\circ\text{C}$)	-6.5	A
	Drain Current – Continuous ($T_c=100^\circ\text{C}$)	-4.1	A
I_{DM}	Drain Current – Pulsed ¹	-26	A
EAS	Single Pulse Avalanche Energy ²	31	mJ
IAS	Single Pulse Avalanche Current ²	25	A
P_D	Power Dissipation ($T_c=25^\circ\text{C}$)	3.3	W
	Power Dissipation – Derate above 25°C	0.03	W/ $^\circ\text{C}$
T_{STG}	Storage Temperature Range	-50 to 150	$^\circ\text{C}$
T_J	Operating Junction Temperature Range	-50 to 150	$^\circ\text{C}$

Thermal Characteristics

Symbol	Parameter	Typ.	Max.	Unit
$R_{\theta JA}$	Thermal Resistance Junction to ambient	---	62	$^\circ\text{C/W}$
$R_{\theta JC}$	Thermal Resistance Junction to Case	---	38	$^\circ\text{C/W}$

Electrical Characteristics (T_J=25 °C, unless otherwise noted)
Off Characteristics

Symbol	Parameter	Conditions	Min.	Typ.	Max.	Unit
BV _{DSS}	Drain-Source Breakdown Voltage	V _{GS} =0V, I _D =-250uA	-40	---	---	V
ΔBV _{DSS} /ΔT _J	BV _{DSS} Temperature Coefficient	Reference to 25°C, I _D =-1mA	---	-0.05	---	V/°C
I _{DSS}	Drain-Source Leakage Current	V _{DS} =-40V, V _{GS} =0V, T _J =25°C	---	---	-1	uA
		V _{DS} =-32V, V _{GS} =0V, T _J =125°C	---	---	-10	uA
I _{GSS}	Gate-Source Leakage Current	V _{GS} =±20V, V _{DS} =0V	---	---	±100	nA

On Characteristics

R _{DS(ON)}	Static Drain-Source On-Resistance	V _{GS} =-10V, I _D =-6A	---	37	45	mΩ
		V _{GS} =-4.5V, I _D =-3A	---	57	72	mΩ
V _{GS(th)}	Gate Threshold Voltage	V _{GS} =V _{DS} , I _D =-250uA	-1.2	-1.6	-2.5	V
ΔV _{GS(th)}	V _{GS(th)} Temperature Coefficient		---	5	---	mV/°C
g _{fs}	Forward Transconductance	V _{DS} =-10V, I _D =-5A	---	7	---	S

Dynamic and switching Characteristics

Q _g	Total Gate Charge ^{3,4}	V _{DS} =-20V, V _{GS} =-4.5V, I _D =-5A	---	8.2	16	nC
Q _{gs}	Gate-Source Charge ^{3,4}		---	3.0	6	
Q _{gd}	Gate-Drain Charge ^{3,4}		---	2.5	5	
T _{d(on)}	Turn-On Delay Time ^{3,4}	V _{DD} =-20V, V _{GS} =-10V, R _G =6Ω I _D =-1A	---	6.3	12	ns
T _r	Rise Time ^{3,4}		---	7.2	14	
T _{d(off)}	Turn-Off Delay Time ^{3,4}		---	46	80	
T _f	Fall Time ^{3,4}		---	14	27	
C _{iss}	Input Capacitance	V _{DS} =-25V, V _{GS} =0V, F=1MHz	---	825	1480	pF
C _{oss}	Output Capacitance		---	68	130	
C _{rss}	Reverse Transfer Capacitance		---	50	100	

Drain-Source Diode Characteristics and Maximum Ratings

Symbol	Parameter	Conditions	Min.	Typ.	Max.	Unit
I _S	Continuous Source Current	V _G =V _D =0V, Force Current	---	---	-6.5	A
I _{SM}	Pulsed Source Current		---	---	-13	A
V _{SD}	Diode Forward Voltage	V _{GS} =0V, I _S =-1A, T _J =25°C	---	---	-1	V

Note :

1. Repetitive Rating : Pulsed width limited by maximum junction temperature.
2. V_{DD}=25V, V_{GS}=10V, L=0.1mH, I_{AS}=25A., Starting T_J=25°C
3. The data tested by pulsed, pulse width ≤ 300us, duty cycle ≤ 2%.
4. Essentially independent of operating temperature.

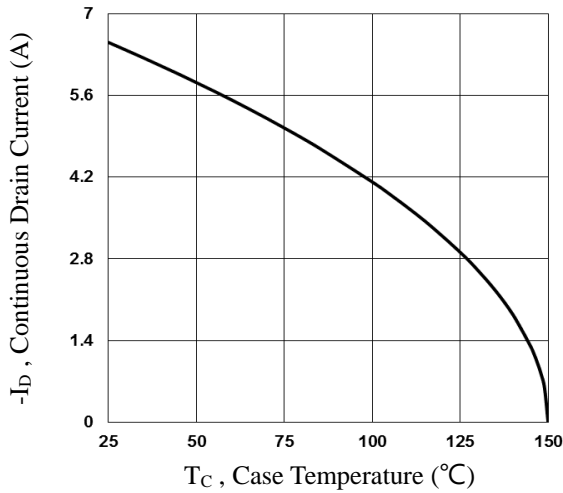

Fig.1 Continuous Drain Current vs. T_c

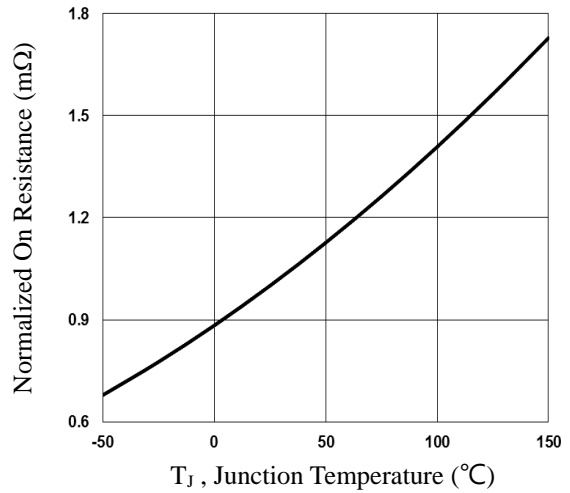

Fig.2 Normalized $R_{DS(on)}$ vs. T_j

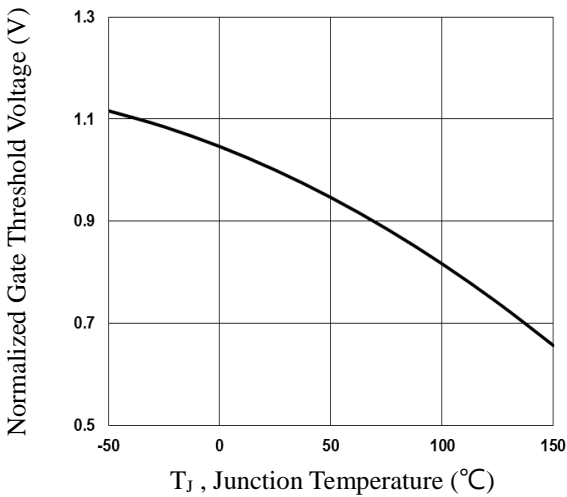

Fig.3 Normalized V_{th} vs. T_j

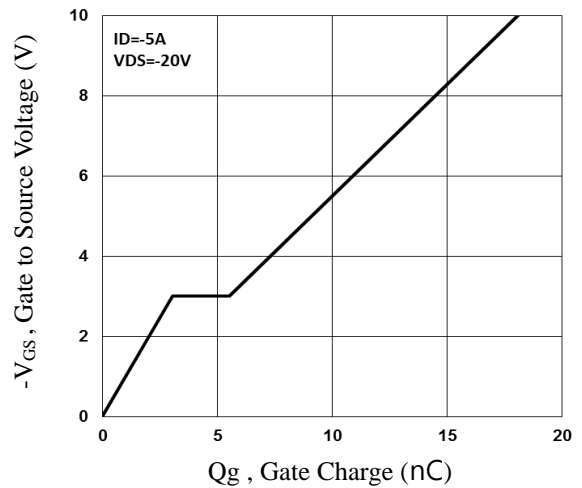

Fig.4 Gate Charge Waveform

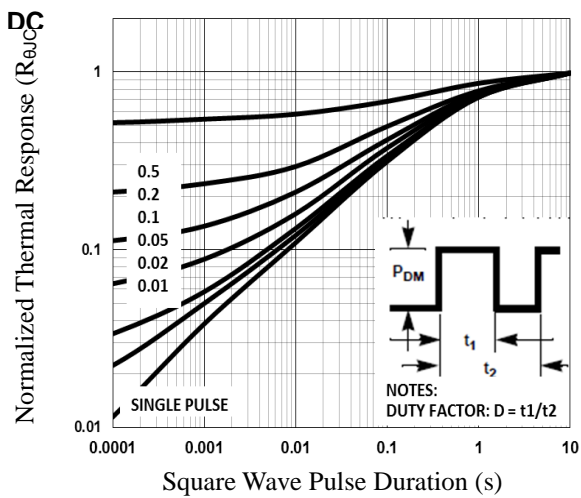

Fig.5 Normalized Transient Impedance

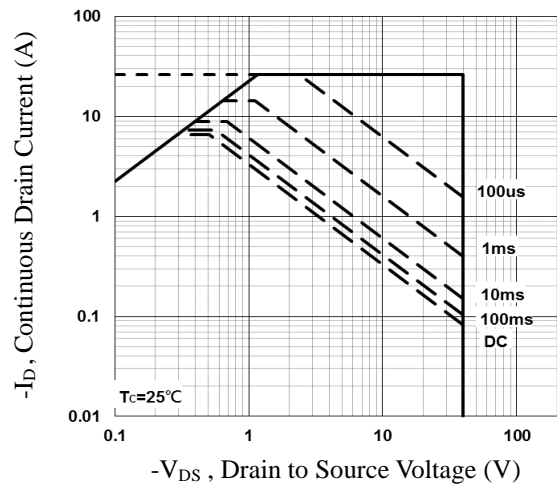

Fig.6 Maximum Safe Operation Area

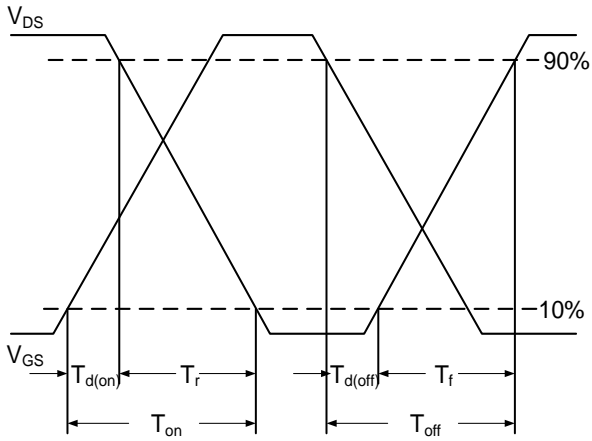

Fig.7 Switching Time Waveform

$$EAS = \frac{1}{2} L \times (-I_{AS})^2 \times \frac{-BV_{DSS}}{-BV_{DSS} - (-V_{DD})}$$

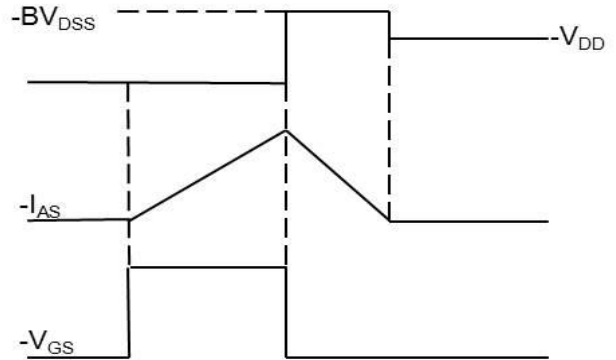
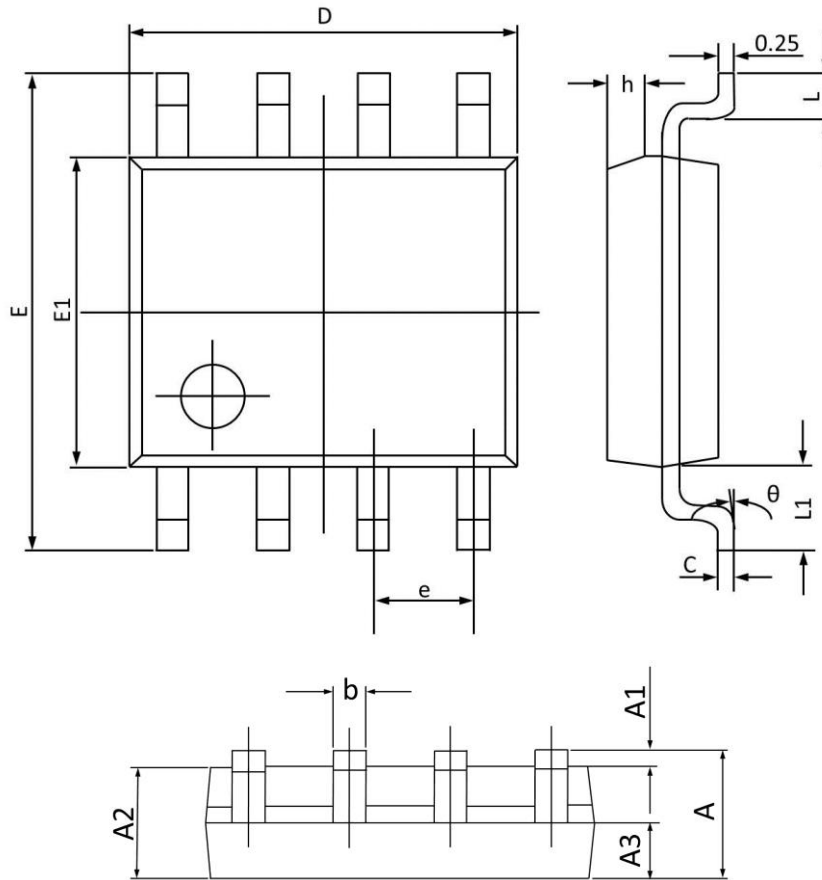

Fig.8 EAS Waveform

SOP8 PACKAGE INFORMATION



Symbol	Dimensions In Millimeters		Dimensions In Inches	
	Min	Max	Min	Max
A	1.350	1.750	0.053	0.068
A1	0.100	0.250	0.004	0.009
A2	1.300	1.500	0.052	0.059
A3	0.600	0.700	0.024	0.027
b	0.390	0.480	0.016	0.018
c	0.210	0.260	0.009	0.010
D	4.700	5.100	0.186	0.200
E	5.800	6.200	0.229	0.244
E1	3.700	4.100	0.146	0.161
e	1.270(BSC)		0.050(BSC)	
h	0.250	0.500	0.010	0.019
L	0.500	0.800	0.019	0.031
L1	1.050(BSC)		0.041(BSC)	
θ	0°	8°	0°	8°

单击下面可查看定价，库存，交付和生命周期等信息

[>>Potens\(博盛\)](#)