

Gas Discharge Tube (GDT) Data Sheet

Features

- Provide ultra - fast response to surge voltage from slow - rising surge of 100V/s to rapid-rising surge of 1KV/ μ s
- Stable breakdown voltage
- High insulation resistance
- Low capacitance (≤ 1.5 pF)
- High holdover voltage
- Large absorbing transient current capability
- Micro -Gap Design
- Size: 5.5mm*6.0mm
- Storage and operating temperature: $-40^{\circ}\text{C} \sim +85^{\circ}\text{C}$
- Meets MSL level 1, per J -STD -020
- Safety certification: E244458



Applications

- Repeaters, Modems
- Telephone Interface, Line cards
- Data communication equipment
- Line test equipment

Part Number Code

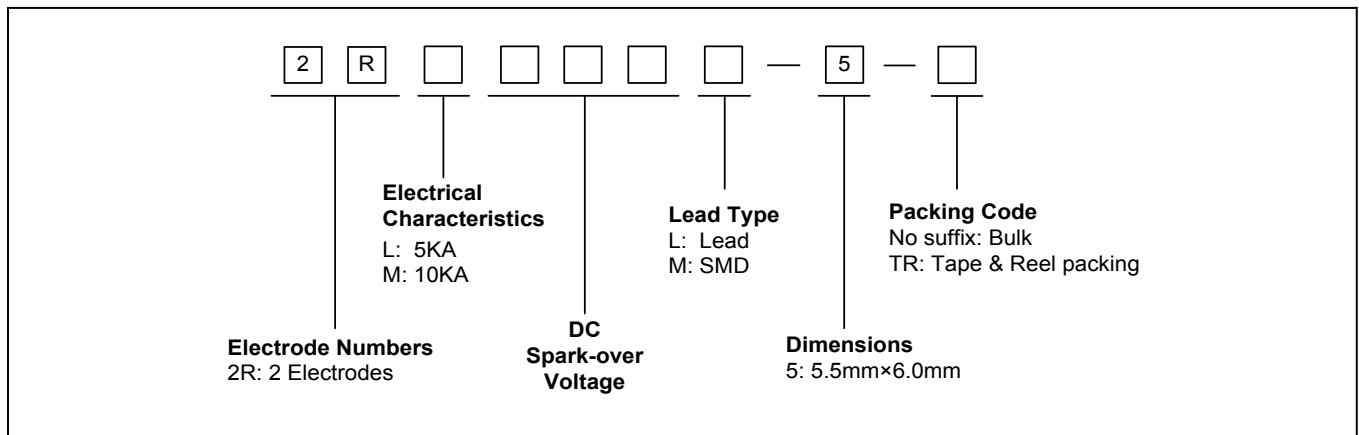

Ordering Code for different package in 2RLxxxxL-5, 2RMxxxxL-5

Box package: Add suffix “/B” at the end of the part number, such as 2RL070L-5/B, 2RM070L-5/B

Reel package: Add suffix “/TR” at the end of the part number, such as 2RL070L-5/TR, 2RM070L-5/TR

Marking

<p>B : BrightKing Logo</p> <p>2RL090-5 : Device Marking Code</p> <p>XXXX : Internal Control Code</p>

Dimensions

L Type	Symbol	Dimension (mm)	
		Spec.	Tolerance
	D	5.5	+0.3, -0.5
	T	6.0	+0.3, -0.5
	d	0.8	±0.1
	L	30.0	Max.
M Type	D	5.5	+0.3, -0.5
	B	0.5	±0.1

Recommended Pad Size	

Electrical Characteristics

Part Number	DC Spark-over Voltage	Maximum Impulse Spark-over Voltage	Nominal Impulse Discharge Current	Alternating Discharge Current	Impulse Life	Minimum Insulation Resistance		Maximum Capacitance	Device Marking Code	
						Test Voltage	(GΩ)			
						(V)	(V)	(KA)		(A)
2RL070L-5	2RL070M-5	70±20%	800	5.0	5.0	300	25	1.0	1.5	2RL070-5
2RL075L-5	2RL075M-5	75±20%	800	5.0	5.0	300	25	1.0	1.5	2RL075-5
2RL090L-5	2RL090M-5	90±20%	700	5.0	5.0	300	50	1.0	1.5	2RL090-5
2RL120L-5	2RL120M-5	120±20%	700	5.0	5.0	300	50	1.0	1.5	2RL120-5
2RL145L-5	2RL145M-5	145±20%	700	5.0	5.0	300	100	1.0	1.5	2RL145-5
2RL150L-5	2RL150M-5	150±20%	700	5.0	5.0	300	100	1.0	1.5	2RL150-5
2RL230L-5	2RL230M-5	230±20%	700	5.0	5.0	300	100	1.0	1.5	2RL230-5
2RL250L-5	2RL250M-5	250±20%	700	5.0	5.0	300	100	1.0	1.5	2RL250-5
2RL300L-5	2RL300M-5	300±20%	900	5.0	5.0	300	100	1.0	1.5	2RL300-5
2RL350L-5	2RL350M-5	350±20%	900	5.0	5.0	300	100	1.0	1.5	2RL350-5
2RL400L-5	2RL400M-5	400±20%	1000	5.0	5.0	300	100	1.0	1.5	2RL400-5
2RL470L-5	2RL470M-5	470±20%	1100	5.0	5.0	300	250	1.0	1.5	2RL470-5
2RL600L-5	2RL600M-5	600±20%	1500	5.0	5.0	300	250	1.0	1.5	2RL600-5
2RL800L-5	2RL800M-5	800±20%	1700	5.0	5.0	300	250	1.0	1.5	2RL800-5

Electrical Characteristics

Part Number		DC Spark-over Voltage	Maximum Impulse Spark-over Voltage	Nominal Impulse Discharge Current	Alternating Discharge Current	Impulse Life	Minimum Insulation Resistance		Maximum Capacitance	Device Marking Code
		100V/s	1000V/ μ s	8/20 μ s 10times	50Hz, 1sec	10/1000 μ s 100A	Test Voltage	(G Ω)	1MHz	
		(V)	(V)	(KA)	(A)	(times)	DC(V)		(pF)	
2RM070L-5	2RM070M-5	70 \pm 20%	600	10	5.0	500	25	1.0	1.5	2RM070-5
2RM075L-5	2RM075M-5	75 \pm 20%	600	10	5.0	500	25	1.0	1.5	2RM075-5
2RM090L-5	2RM090M-5	90 \pm 20%	600	10	10	500	50	1.0	1.5	2RM090-5
2RM120L-5	2RM120M-5	120 \pm 20%	600	10	10	500	50	1.0	1.5	2RM120-5
2RM145L-5	2RM145M-5	145 \pm 20%	700	10	10	500	100	1.0	1.5	2RM145-5
2RM150L-5	2RM150M-5	150 \pm 20%	700	10	10	500	100	1.0	1.5	2RM150-5
2RM230L-5	2RM230M-5	230 \pm 20%	700	10	10	500	100	1.0	1.5	2RM230-5

Electrical Ratings

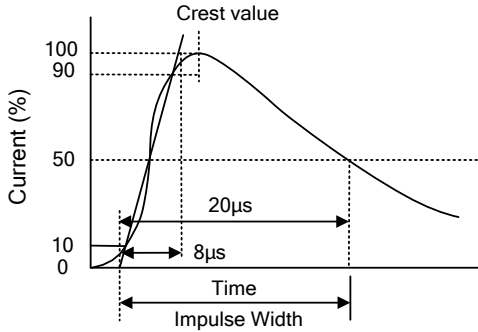
Items	Test Condition/Description	Requirement
DC Spark-over Voltage	The voltage is measured with voltage ramp $dv/dt=100V/s$.	To meet the specified value
Maximum Impulse Spark-over Voltage	The maximum impulse spark-over voltage is measured with voltage ramp $dv/dt=1000V/\mu s$.	
Impulse Discharge Current	<p>Maximum 8/20μs surge current that can be applied between two electrodes, 5 positive and 5 negative surges, with 3 minutes interval time, without causing the DC spark-over voltage to change more than 25% from its initial value.</p> 	
Alternating Discharge Current	Rated RMS value of AC current at 50Hz, 1 sec. for 10 times with interval time 3 min. DC spark-over voltage shall not change more than $\pm 25\%$ from its initial value. $IR > 10^8$ ohms (-20%, +30% for 70~90V).	
Insulation Resistance	The resistance of gas tube shall be measured between two electrodes.	
Capacitance	The capacitance of gas tube shall be measured between two electrodes. Test frequency: 1MHz	

Recommended Soldering Conditions

Wave Soldering

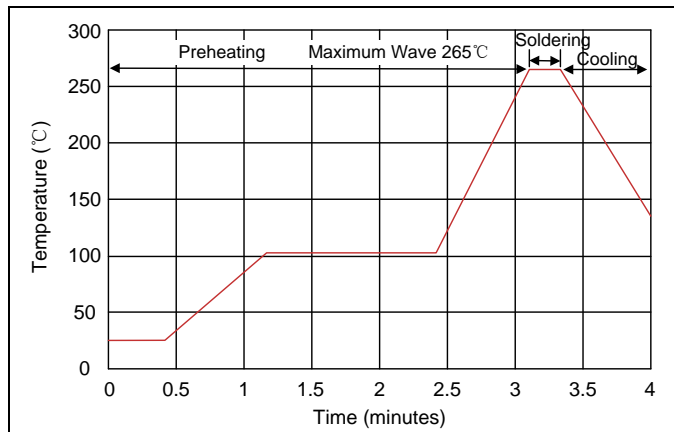

Item	Conditions
Peak Temperature	265°C
Dipping Time	10 seconds
Soldering	1 time

Reflow Soldering

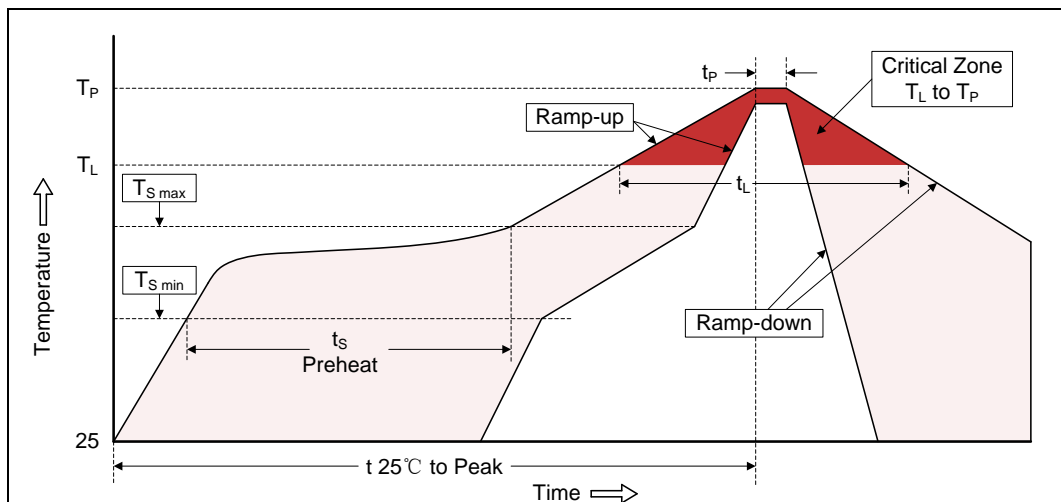

Profile Feature	Pb-Free Assembly
Average ramp-up rate (T_L to T_P)	3°C/second max.
Preheat	
-Temperature Min ($T_{S\ min}$)	150°C
-Temperature Max ($T_{S\ max}$)	200°C
-Time (min to max) (t_s)	60-180 seconds
$T_{S\ max}$ to T_L	
-Ramp-up Rate	3°C/second max.
Time maintained above:	
-Temperature (T_L)	217°C
-Time (t_L)	60-150 seconds
Peak Temperature (T_P)	260°C
Time within 5°C of actual Peak Temperature (t_p)	20-40 seconds
Ramp-down Rate	6°C/second max.
Time 25°C to Peak Temperature	8 minutes max.

Packaging

Axial Packing (Bulk)

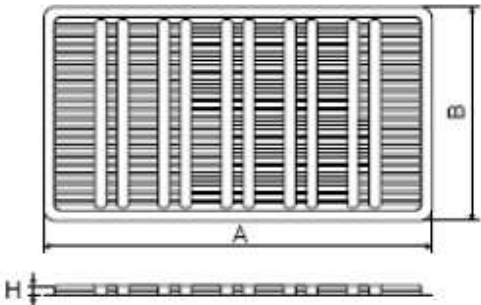
Skin packing	Dimension (mm)	
	Symbol	Spec. / Tolerance
	A	265.0 ±5.0
	B	146.0 ±5.0
	H	6.8 ±0.5
	Quantity: 100pcs	
Inner box	Dimension (mm)	
	Symbol	Spec. / Tolerance
	A0	270.0 ±2.0
	B0	150.0 ±2.0
H0	50.0 ±2.0	
Quantity: 500pcs		

Axial Packing (Tape & Reel)

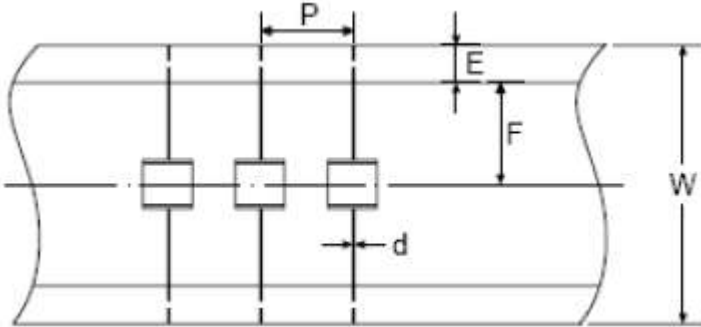
Tape	Dimension (mm)		
	Symbol	Spec. / Tolerance	
	P	10.0 ±0.5	
	W	65.0 ±1.0	
	E	6.0 ±0.5	
	F	26.5 ±0.5	
	d	0.8 ±0.1	
	Reel	Dimension (mm)	
		Symbol	Spec. / Tolerance
A1		330.0 ±2.0	
B1		70.0 ±2.0	
C1		82.0 ±2.0	
D		25.0 ±0.5	
t	2.0 ±0.2		
Quantity: 1000pcs			

Packaging

SMD Packing (Tape & Reel)

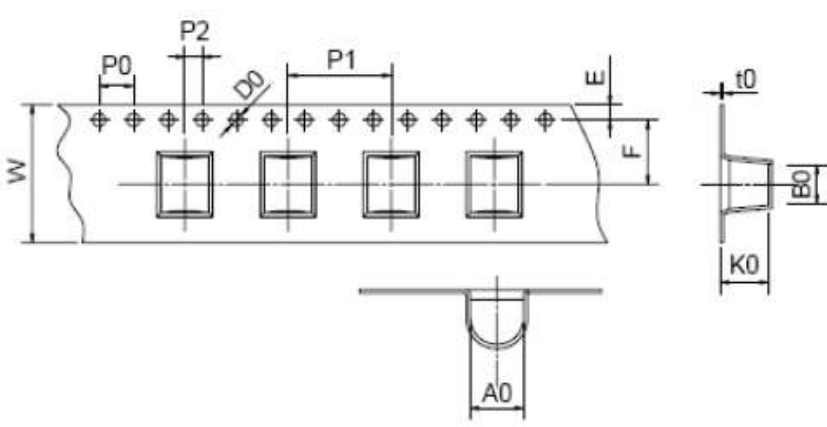
Tape	Symbol	Dimension (mm)		
		Spec.	Tolerance	
	W	16.00	±0.20	
	P0	4.00	±0.10	
	P1	12.00	±0.20	
	P2	2.00	±0.10	
	D0	1.55	±0.05	
	E	1.75	±0.10	
	F	7.50	±0.10	
	A0	5.85	±0.10	
	K0	6.20	±0.10	
	B0	7.00	±0.10	
	t0	0.50	±0.10	
	Reel	D	330.00	±2.00
		d	13.00	±0.50
L		20.00	±2.00	
t		2.00	±0.20	
Quantity: 800pcs				

单击下面可查看定价，库存，交付和生命周期等信息

[>>Brightking\(君耀电子\)](#)