

REVISIONS					
P	LTR	DESCRIPTION	DATE	DWN	APVD
	C1	REVISED PER ECR-20-100273	13AUG2020	M.M	D.Z

トレードマーク
TRADE MARK

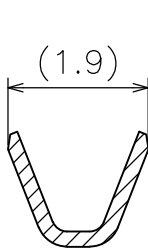

断面 A-A
SECT A-A

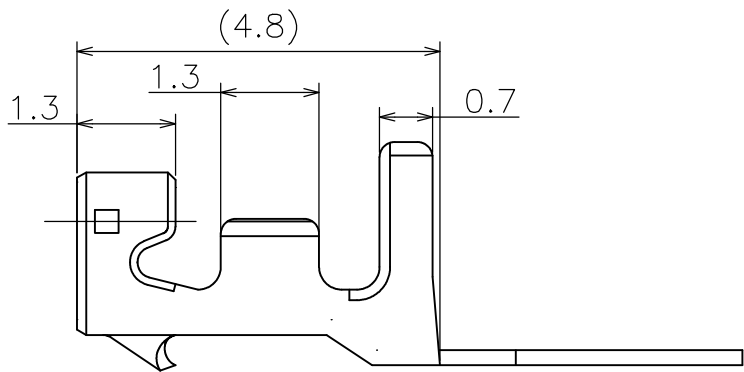
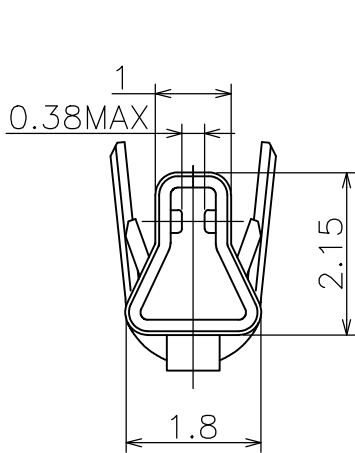
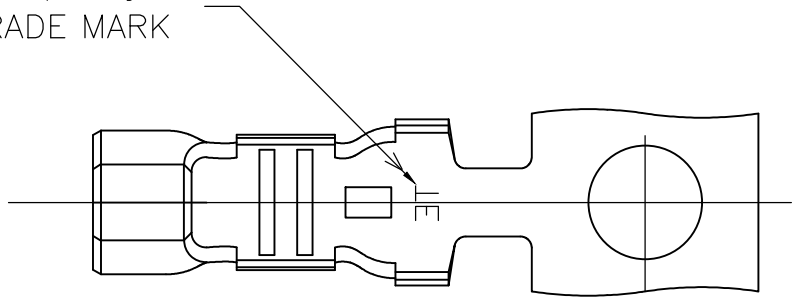
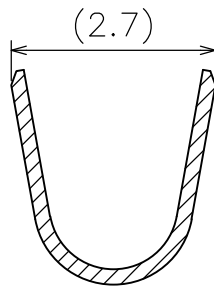

断面 B-B
SECT B-B

PRE TINNED PHOSPHOR BRONZE (0.2t) 錫めっき済み磷青銅 (板厚 0.2)	0-1376476-1
MATERIAL 材料	PART No 型番

WIRE RANGE 抱合電線断面積 AWG #26~# 22(0.12~0.38mm ²)	INSULATION DIA 被覆外径 φ1.2 ~1.9
--	-------------------------------------

TE Connectivity. All Rights Reserved.
© 2020

DIMENSIONS: 単位: 耗 mm	DWN N.YAMASAKI 13AUG2020
TOLERANCES UNLESS OTHERWISE SPECIFIED: 一般公差	CHK M.SHINDO 20 SEP '02
0 PLC ± 0.2	APVD Y.KASHIWA 20 SEP '02
1 PLC ± 0.2	PRODUCT SPEC 製品規格 108-5703
2 PLC ± 0.2	APPLICATION SPEC 取付適用規格 114-5286
3 PLC ± -	WEIGHT
4 PLC ± -	
ANGLES ± 3°	

MATERIAL 材料	SEE TABLE
FINISH 仕上げ	-
NAME 名称	2.5MM SIGNAL MATE CONN REC CONT
SIZE	A4
CAGE CODE	00779
DRAWING NO 番号	1376476
RESTRICTED TO	-



TE Connectivity

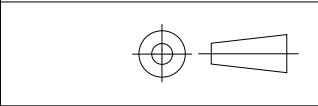

CUSTOMER DRAWING	SCALE 尺度	1:1	SHEET	1 OF 1	REV	C1
------------------	-------------	-----	-------	--------	-----	----

单击下面可查看定价，库存，交付和生命周期等信息

[>>TE Connectivity\(泰科\)](#)