

High and Low Side Driver

Features

- Floating channel designed for bootstrap operation
- Fully operational to +600V
- Tolerant to negative transient voltage
- dV/dt immune
- Gate drive supply range from 10 to 20V
- Undervoltage lockout for both channels
- 3.3V logic compatible
- Separate logic supply range from 3.3V to 20V
- Logic and power ground $\pm 5V$ offset
- CMOS Schmitt-triggered inputs with pull-down
- Cycle by cycle edge-triggered shutdown logic
- Matched propagation delay for both channels
- Outputs in phase with inputs

Description

The IR25607 is a high voltage, high speed power MOSFET and IGBT driver with independent high and low side referenced output channels. Proprietary HVIC and latch immune CMOS technologies enable ruggedized monolithic construction. Logic inputs are compatible with standard CMOS or LSTTL output, down to 3.3V logic. The output drivers feature a high pulse current buffer stage designed for minimum driver cross-conduction. Propagation delays are matched to simplify use in high frequency applications. The floating channel can be used to drive an N-channel power MOSFET or IGBT in the high side configuration which operates up to 600 V.

Product Summary

V_{OFFSET}	600V max.
$I_{O+/-}$	2A / 2A
V_{OUT}	10 – 20V
Ton/off (typ.)	120 & 94 ns
Delay Matching (typ.)	20 ns

Package Options

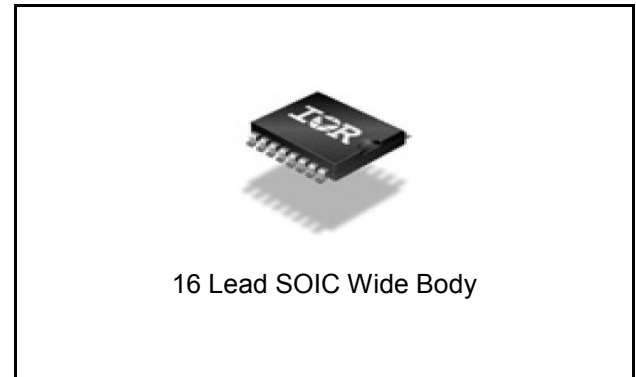

Ordering Information

Base Part Number	Package Type	Standard Pack		Orderable Part Number
		Form	Quantity	
IR25607SPBF	SO16W	Tube	45	IR25607SPBF
IR25607SPBF	SO16W	Tape and Reel	1000	IR25607STRPBF

Typical Connection Diagram

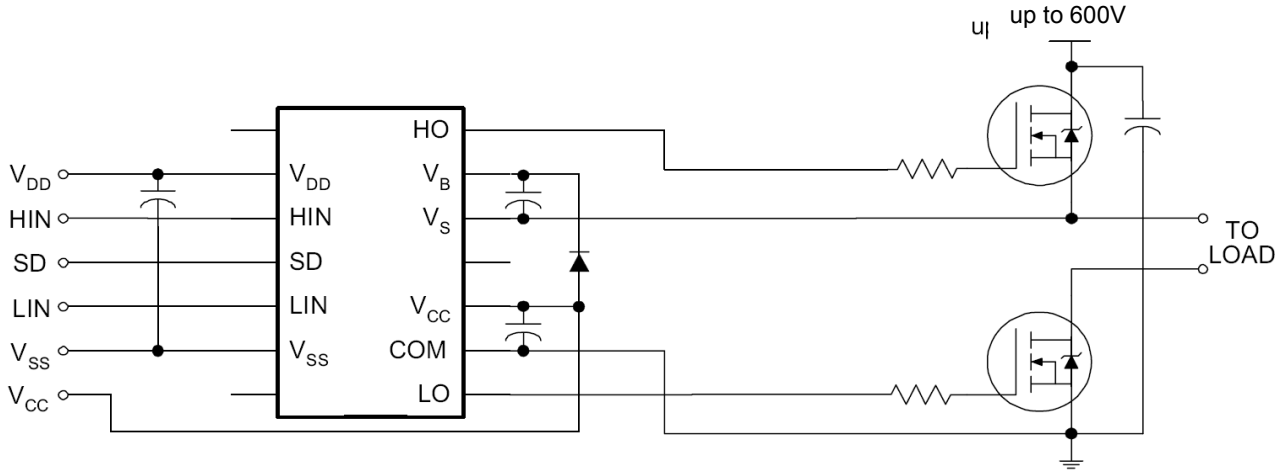

(Refer to Lead Assignments for correct pin configuration). This/These diagram(s) show electrical connections only. Please refer to our Application Notes and DesignTips for proper circuit board layout.

Absolute Maximum Ratings

Absolute maximum ratings indicate sustained limits beyond which damage to the device may occur. All voltage parameters are absolute voltages referenced to COM. The thermal resistance and power dissipation ratings are measured under board mounted and still air conditions.

Symbol	Definition	Min.	Max.	Units
V_B	High side floating supply voltage	-0.3	625	V
V_S	High side floating supply offset voltage	$V_B - 25$	$V_B + 0.3$	
V_{HO}	High side floating output voltage	$V_S - 0.3$	$V_B + 0.3$	
V_{CC}	Low side and logic fixed supply voltage	-0.3	25	
V_{LO}	Low side output voltage	-0.3	$V_{CC} + 0.3$	
V_{DD}	Logic supply voltage	-0.3	$V_{SS} + 25$	
V_{SS}	Logic supply offset voltage	$V_{CC} - 25$	$V_{CC} + 0.3$	
V_{IN}	Logic input voltage (HIN, LIN & SD)	$V_{SS} - 0.3$	$V_{DD} + 0.3$	
dVs/dt	Allowable offset supply voltage transient	—	50	V/ns
P_D	Package power dissipation @ $T_A \leq +25^\circ\text{C}$	—	1.25	W
R_{thJA}	Thermal resistance, junction to ambient	—	100	$^\circ\text{C/W}$
T_J	Junction temperature	—	150	$^\circ\text{C}$
T_S	Storage temperature	-55	150	
T_L	Lead temperature (soldering, 10 seconds)	—	300	

Recommended Operating Conditions

For proper operation the device should be used within the recommended conditions. The V_S and V_{SS} offset ratings are tested with all supplies biased at 15V differential.

Symbol	Definition	Min.	Max.	Units
V_B	High side floating supply absolute voltage	$V_S + 10$	$V_S + 20$	V
V_S	High side floating supply offset voltage	†	600	
V_{HO}	High side floating output voltage	V_S	V_B	
V_{CC}	Low side fixed supply voltage	10	20	
V_{LO}	Low side output voltage	0	V_{CC}	
V_{DD}	Logic supply voltage	$V_{SS} + 3$	$V_{SS} + 20$	
V_{SS}	Logic supply offset voltage	-5 ††	5	
V_{IN}	Logic input voltage (HIN, LIN & SD)	V_{SS}	V_{DD}	
T_A	Ambient temperature	-40	125	$^\circ\text{C}$

† Logic operational for V_S of -5 to +600V. Logic state held for V_S of -5V to -V_{BS}. (Please refer to Design Tip DT97-3 for more details).

†† When $V_{DD} < 5V$, the minimum V_{SS} offset is limited to $-V_{DD}$.

Dynamic Electrical Characteristics

V_{BIAS} (V_{CC} , V_{BS} , V_{DD}) = 15V, C_L = 1000 pF, V_{SS} = COM and T_A = 25°C unless otherwise specified.

Symbol	Definition	Min.	Typ.	Max.	Units	Test Conditions
t_{on}	Turn-on propagation delay	—	120	150	ns	$V_S = 0V$
t_{off}	Turn-off propagation delay	—	94	125		$V_S = 600V$
t_{sd}	Shutdown propagation delay	—	110	140		$V_S = 600V$
t_r	Turn-on rise time	—	25	35		
t_f	Turn-off fall time	—	17	25		
MT	Delay matching, HS & LS turn-on/off	—	—	20		

Static Electrical Characteristics

V_{BIAS} (V_{CC} , V_{BS} , V_{DD}) = 15V, V_{SS} = COM and T_A = 25°C unless otherwise specified. The V_{IN} , V_{TH} and I_{IN} parameters are referenced to V_{SS} and are applicable to all three logic input leads: HIN, LIN and SD. The V_O and I_O parameters are referenced to COM and are applicable to the respective output leads: HO and LO.

Symbol	Definition	Min.	Typ.	Max.	Units	Test Conditions
V_{IH}	Logic "1" input voltage	9.5	—	—	V	
V_{IL}	Logic "0" input voltage	—	—	6.0		
V_{OH}	High level output voltage, $V_{BIAS} - V_O$	—	—	1.2		$I_O = 0A$
V_{OL}	Low level output voltage, V_O	—	—	0.1		$I_O = 0A$
I_{LK}	Offset supply leakage current	—	—	50	μA	$V_B = V_S = 600V$
I_{QBS}	Quiescent V_{BS} supply current	—	125	230		$V_{IN} = 0V$ or V_{DD}
I_{QCC}	Quiescent V_{CC} supply current	—	180	340		$V_{IN} = 0V$ or V_{DD}
I_{QDD}	Quiescent V_{CC} supply current	—	15	30		$V_{IN} = 0V$ or V_{DD}
I_{IN+}	Logic "1" input bias current	—	20	40		$V_{IN} = V_{DD}$
I_{IN-}	Logic "0" input bias current	—	—	1		$V_{IN} = 0V$
V_{BSUV+}	V_{BS} supply undervoltage positive going threshold	7.5	8.6	9.7	V	
V_{BSUV-}	V_{BS} supply undervoltage negative going threshold	7.0	8.2	9.4		
V_{CCUV+}	V_{CC} supply undervoltage positive going threshold	7.4	8.5	9.6		
V_{CCUV-}	V_{CC} supply undervoltage negative going threshold	7.0	8.2	9.4		
I_{O+}	Output high short circuit pulsed current	2	2.5	—	A	$V_O = 0V$, $V_{IN} = V_{DD}$ $PW \leq 10 \mu s$
I_{O-}	Output low short circuit pulsed current	2	2.5	—		$V_O = 15V$, $V_{IN} = V_{DD}$ $PW \leq 10 \mu s$

Lead Definitions

Symbol	Description
V _{DD}	Logic supply
HIN	Logic input for high side gate driver output (HO), in phase
SD	Logic input for shutdown
LIN	Logic input for low side gate driver output (LO), in phase
V _{SS}	Logic ground
V _B	High side floating supply
HO	High side gate drive output
V _S	High side floating supply return
V _{CC}	Low side and logic fixed supply
LO	Low side gate drive output
COM	Low side return

Lead Assignments

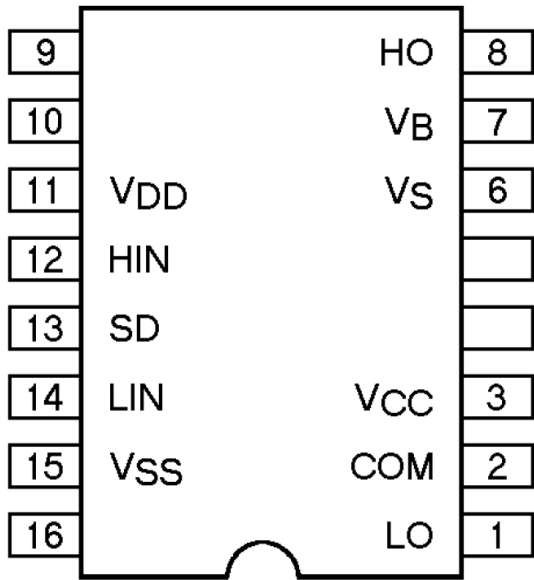

Application Information and Additional Details

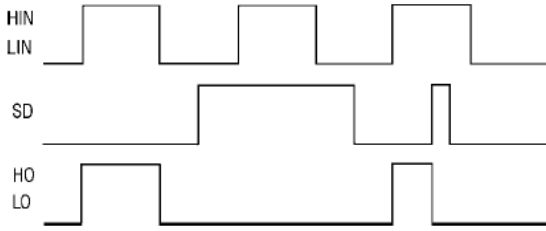

Figure 1. Input/Output Timing Diagram

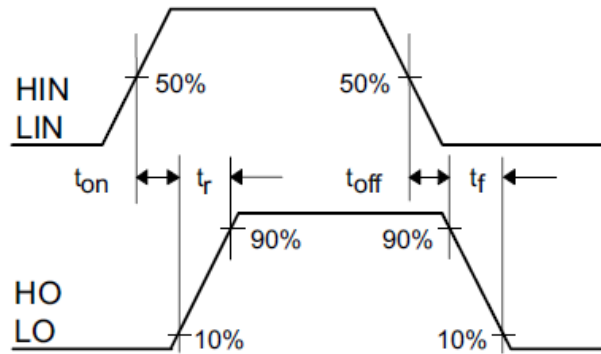

Figure 2. Switching Time Waveform Definitions

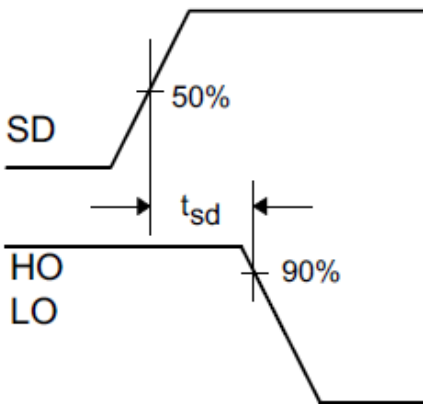

Figure 3. Shutdown Waveform Definitions

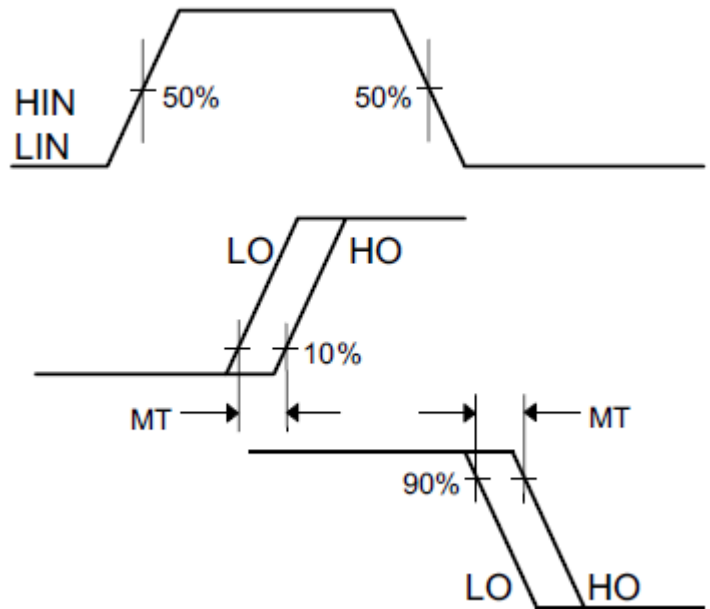

Figure 4. Delay matching Waveform Definitions

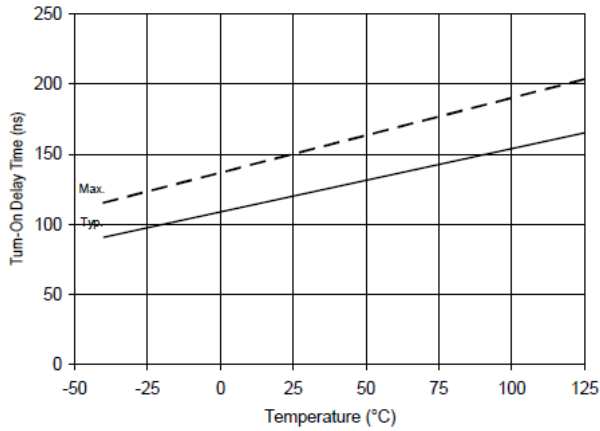

Figure 5A. Turn On Time vs. Temperature

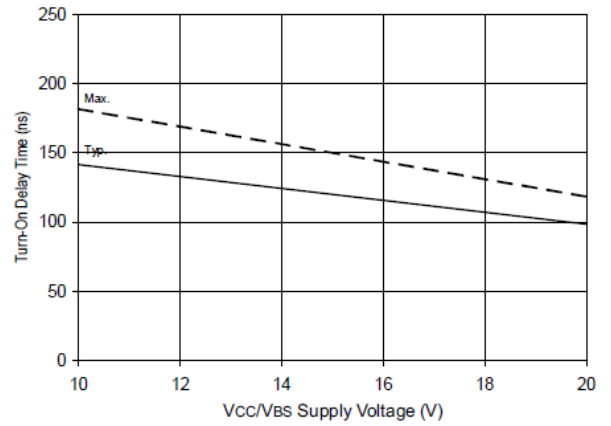

Figure 5B. Turn On Time vs. V_{CC}/V_{BS} Supply Voltage

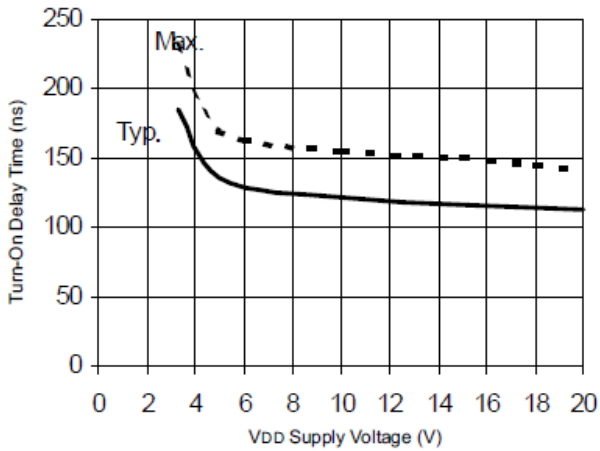

Figure 5C. Turn On Time vs. V_{DD} Supply Voltage

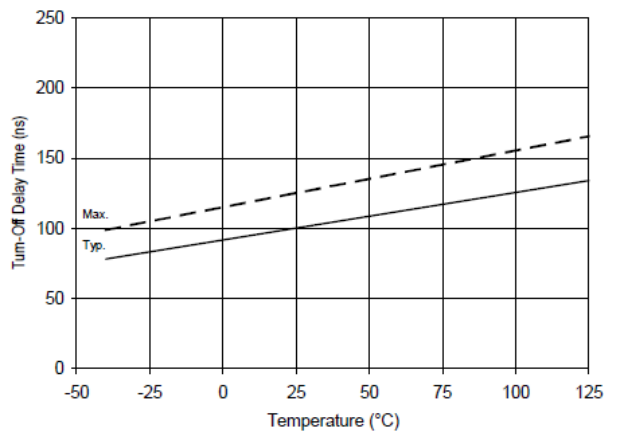

Figure 6A. Turn Off Time vs. Temperature

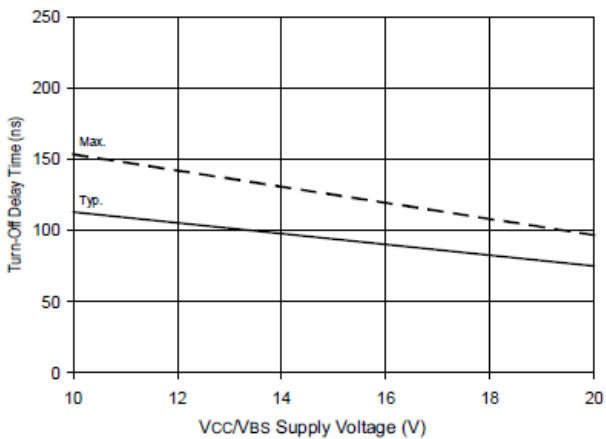

Figure 6B. Turn Off Time vs. V_{CC}/V_{BS} Supply Voltage

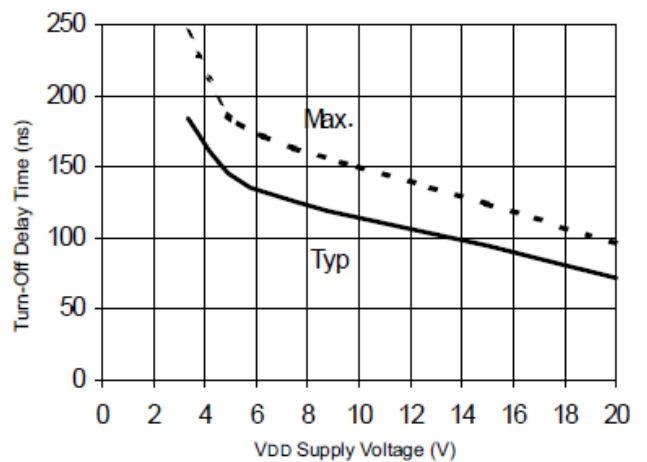

Figure 6C. Turn Off Time vs. V_{DD} Supply Voltage

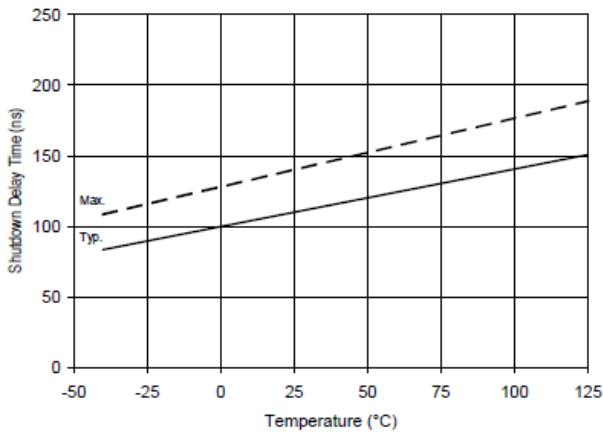

Figure 7A. Shutdown Time vs. Temperature

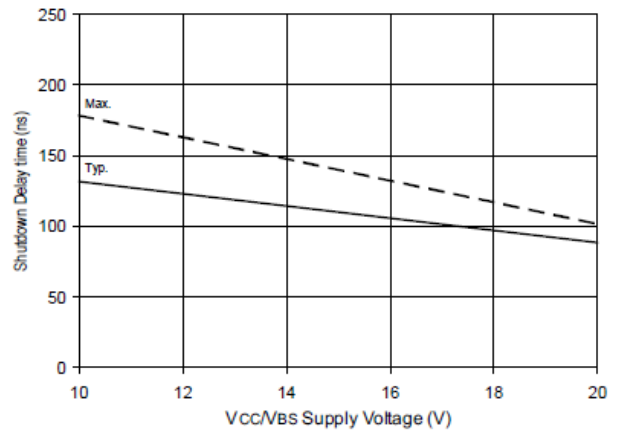

Figure 7B. Shutdown Time vs. V_{CC}/V_{BS} Supply Voltage

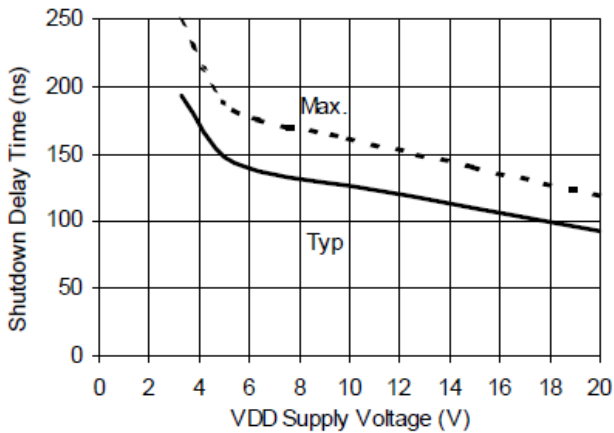

Figure 7C. Shutdown Time vs. V_{DD} Supply Voltage

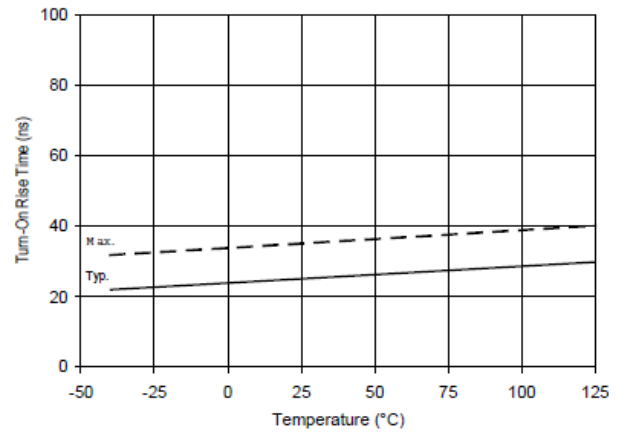

Figure 8A. Turn On Rise Time vs. Temperature

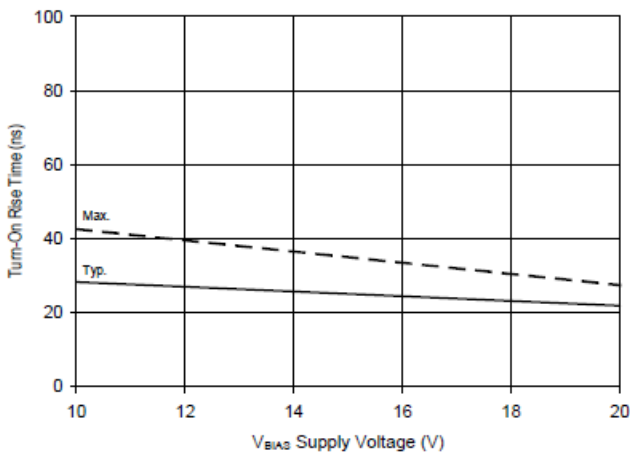

Figure 8B. Turn On Rise Time vs. Voltage

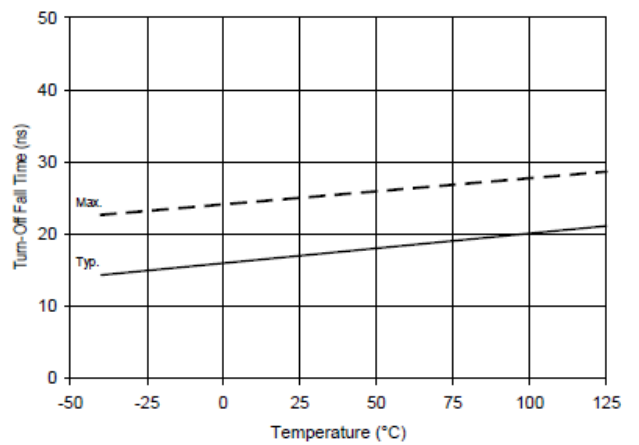

Figure 9A. Turn Off Fall Time vs. Temperature

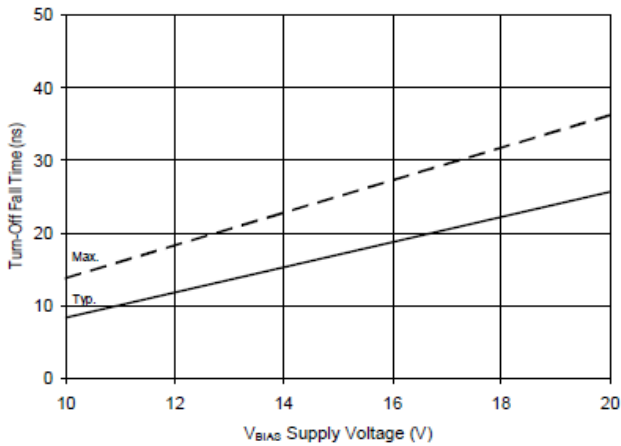

Figure 9B. Turn Off Fall Time vs. Voltage

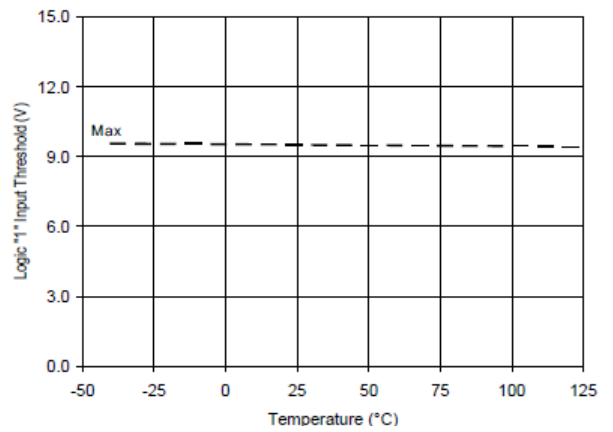

Figure 10A. Logic '1' Input Threshold vs. Temperature

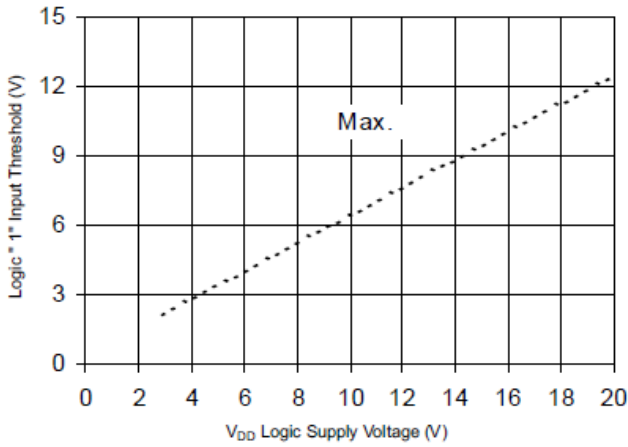

Figure 10B. Logic '1' Input Threshold vs. Voltage

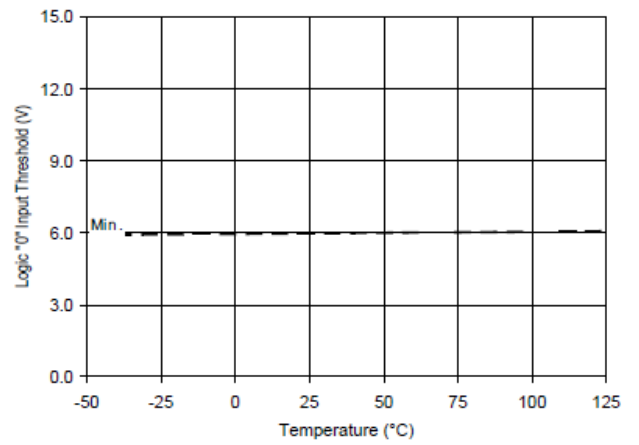

Figure 11A. Logic '0' Input Threshold vs. Temperature

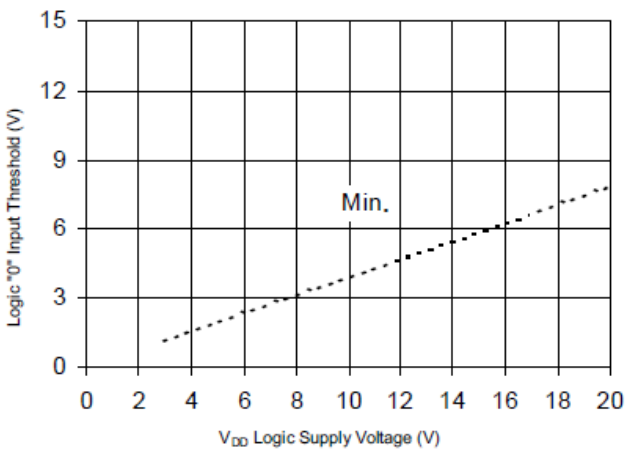

Figure 11B. Logic '0' Input Threshold vs. Voltage

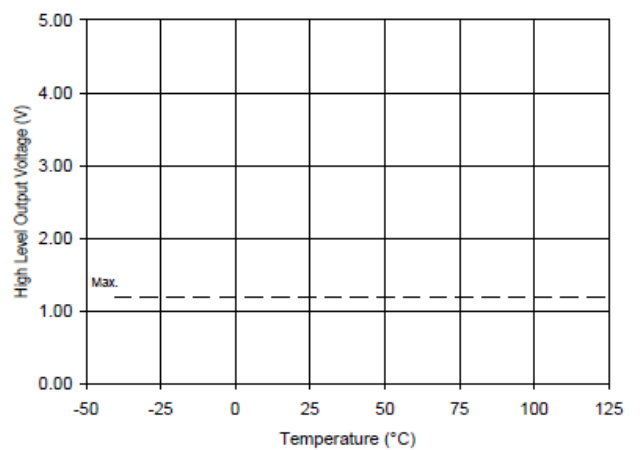

Figure 12A. High Level Output vs. Temperature

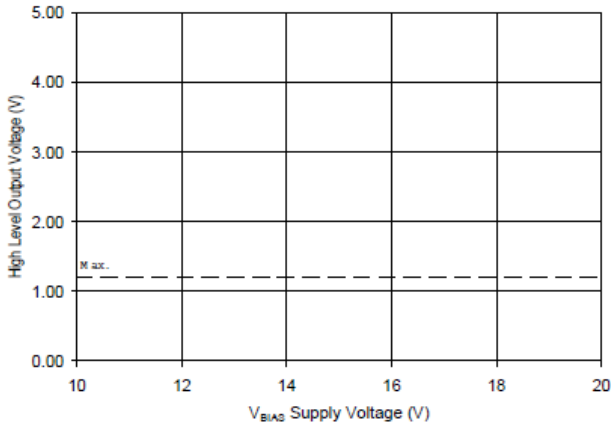

Figure 12B. High Level Output vs. Voltage

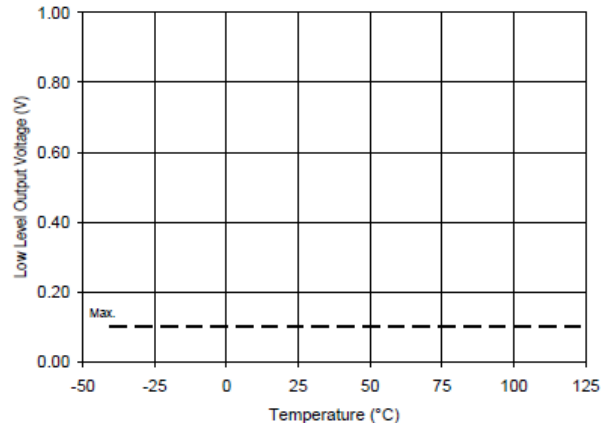

Figure 13A. Low Level Output vs. Temperature

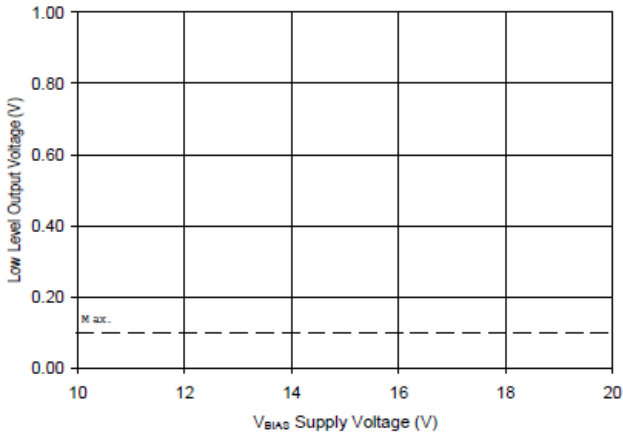

Figure 13B. Low Level Output vs. Voltage

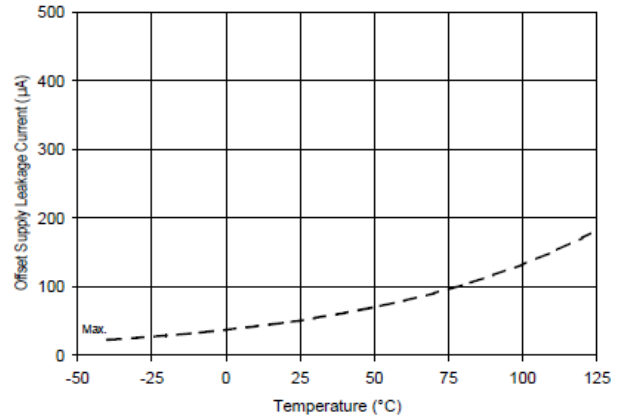

Figure 14A. Offset Supply Current vs. Temperature

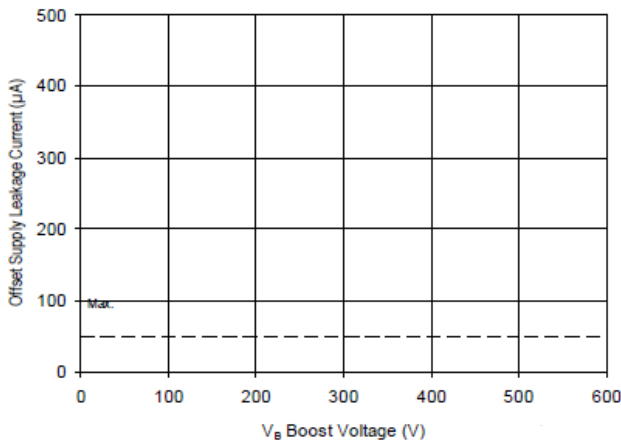

Figure 14B. Offset Supply Current vs. Voltage

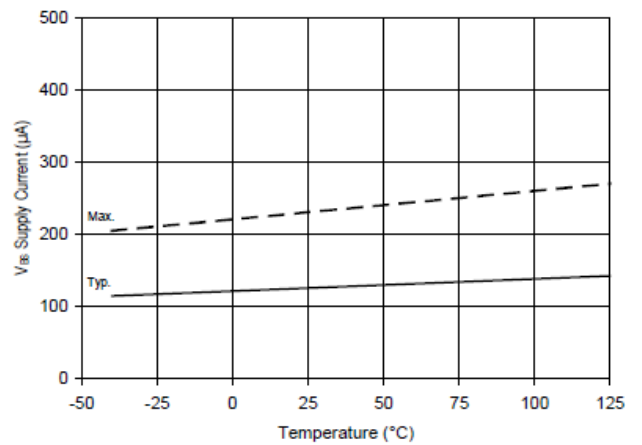

Figure 15A. V_{BS} Supply Current vs. Temperature

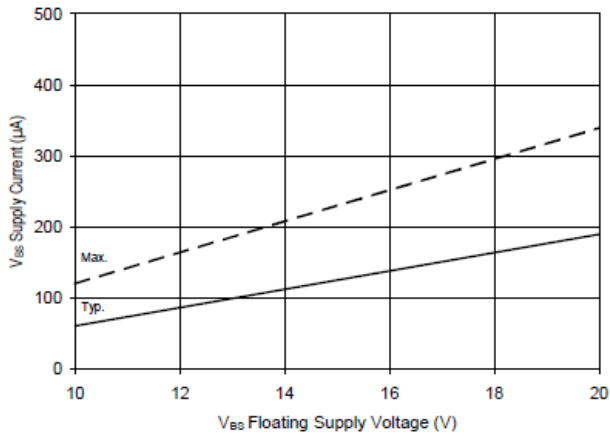

Figure 15B. V_{BS} Supply Current vs. Voltage

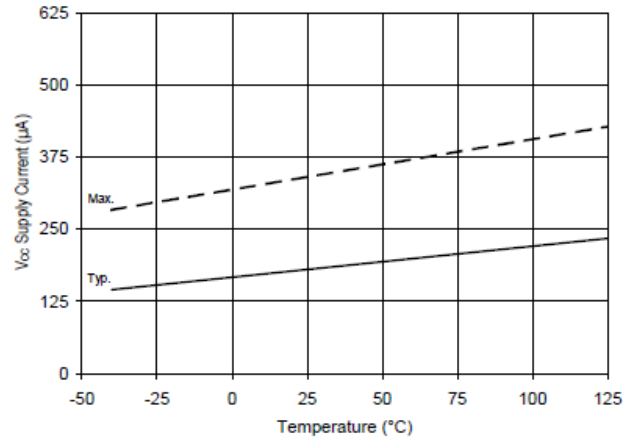

Figure 16A. V_{CC} Supply Current vs. Temperature

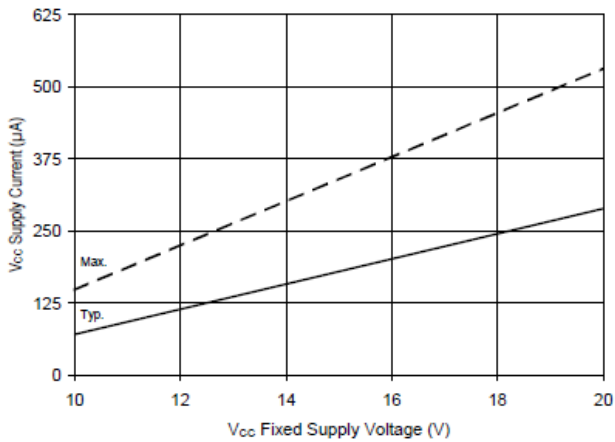

Figure 16B. V_{CC} Supply Current vs. Voltage

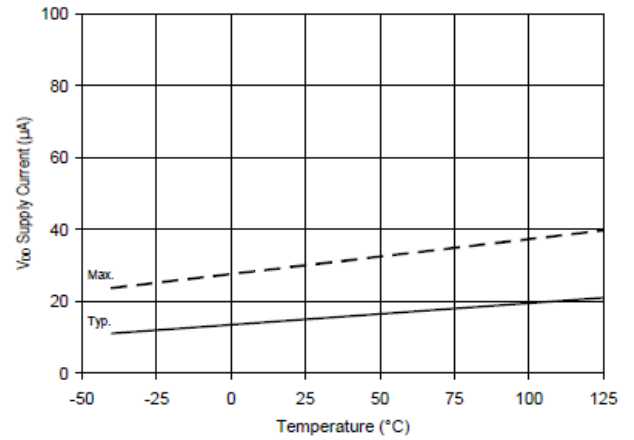

Figure 17A. V_{DD} Supply Current vs. Temperature

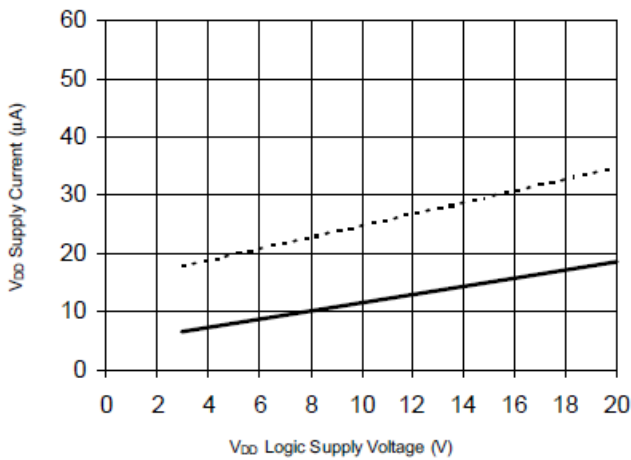

Figure 17B. V_{DD} Supply Current vs. V_{DD} Voltage

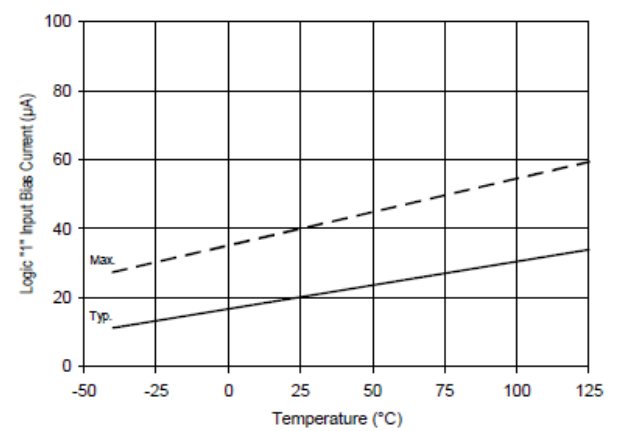

Figure 18A. Logic '1' Input Current vs. Temperature

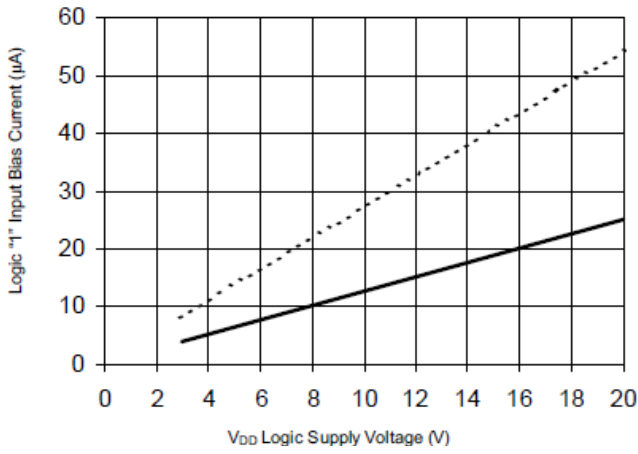

Figure 18B. Logic '1' Input Current vs. V_{DD} Voltage

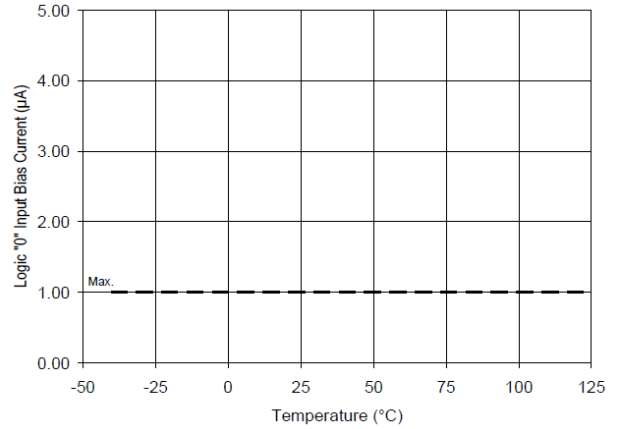

Figure 19A. Logic '0' Input Current vs. Temperature

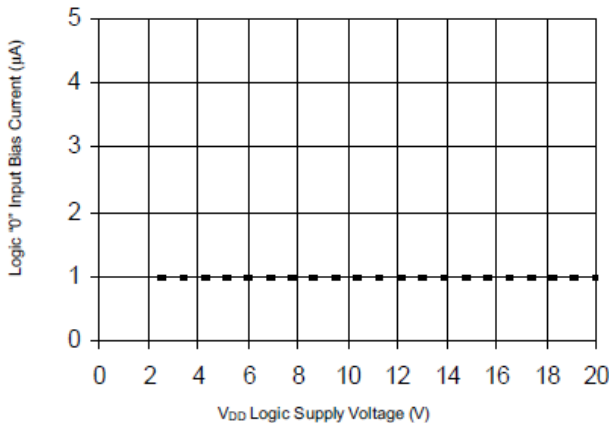

Figure 19B. Logic '0' Input Current vs. V_{DD} Voltage

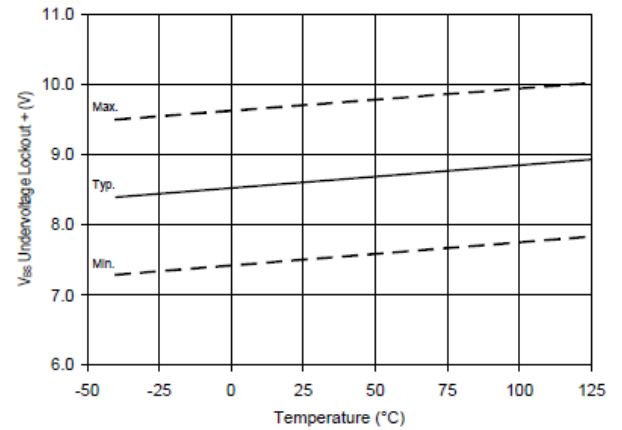

Figure 20. V_{BS} Undervoltage (+) vs. Temperature

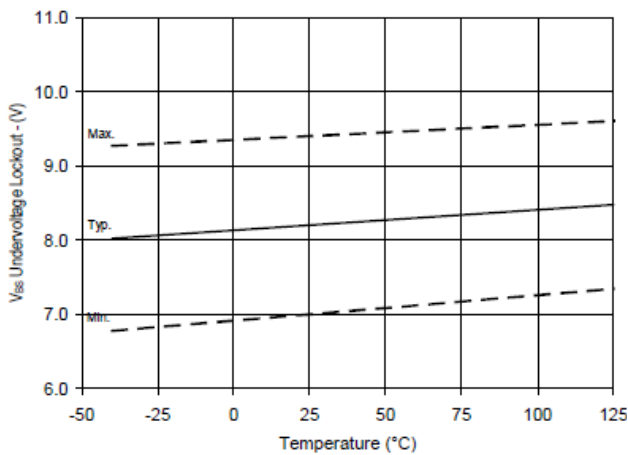

Figure 21 V_{BS} Undervoltage (-) vs. Temperature

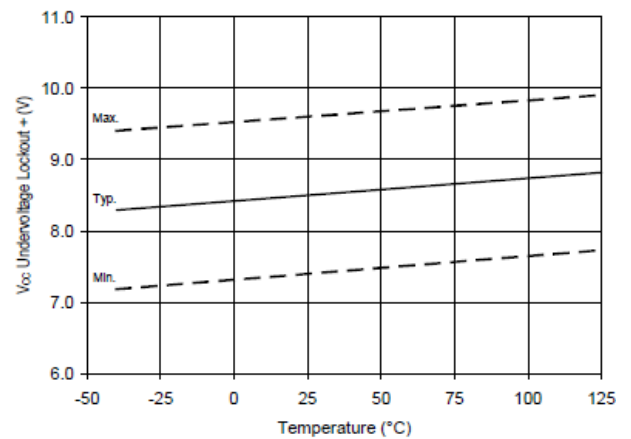

Figure 22. V_{CC} Undervoltage (+) vs. Temperature

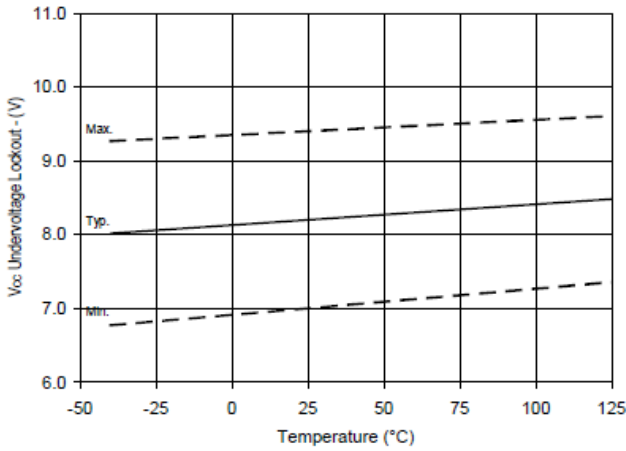

Figure 23. V_{CC} Undervoltage (-) vs. Temperature

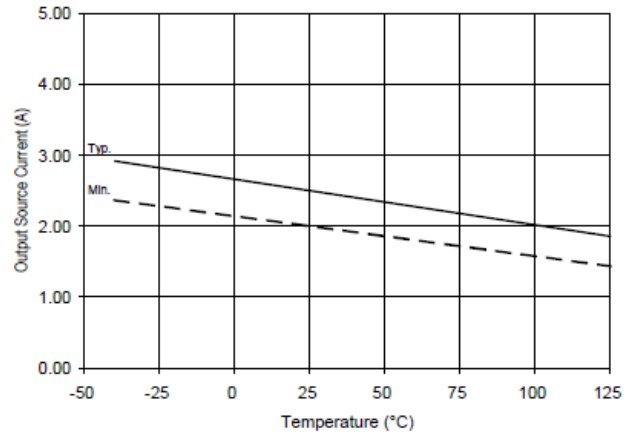

Figure 24A. Output Source Current vs. Temperature

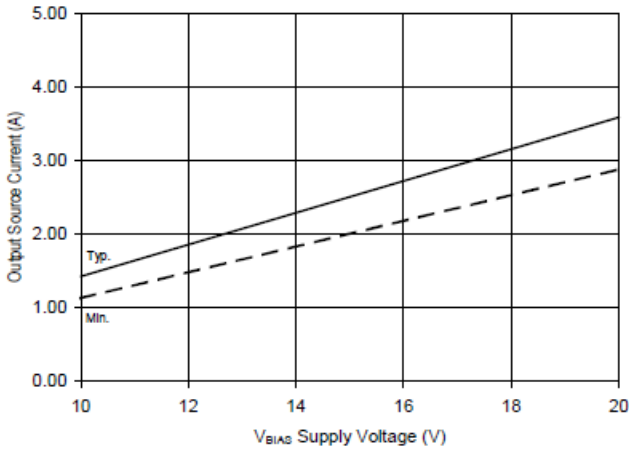

Figure 24B. Output Source Current vs. Voltage

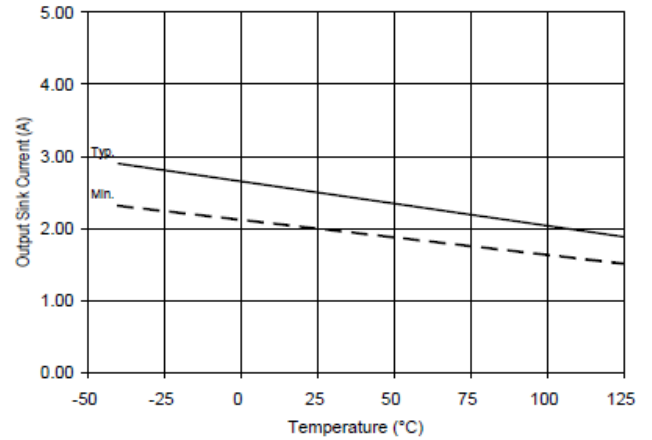

Figure 25A. Output Sink Current vs. Temperature

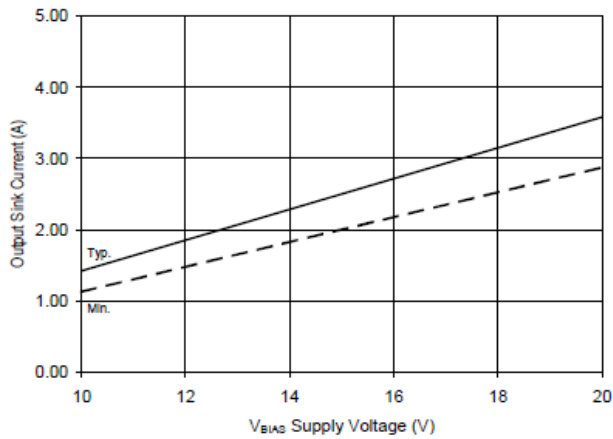

Figure 25B. Output Sink Current vs. Voltage

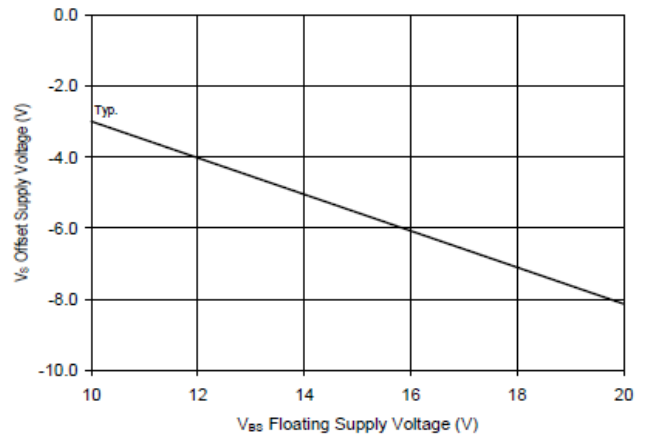

Figure 26. Maximum V_S Negative Offset vs. V_{BS} Supply Voltage

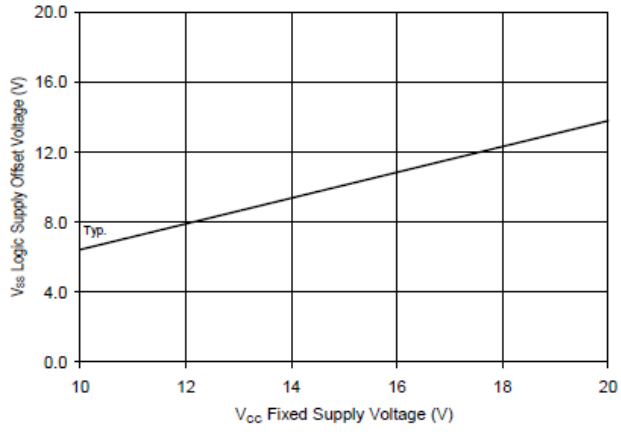
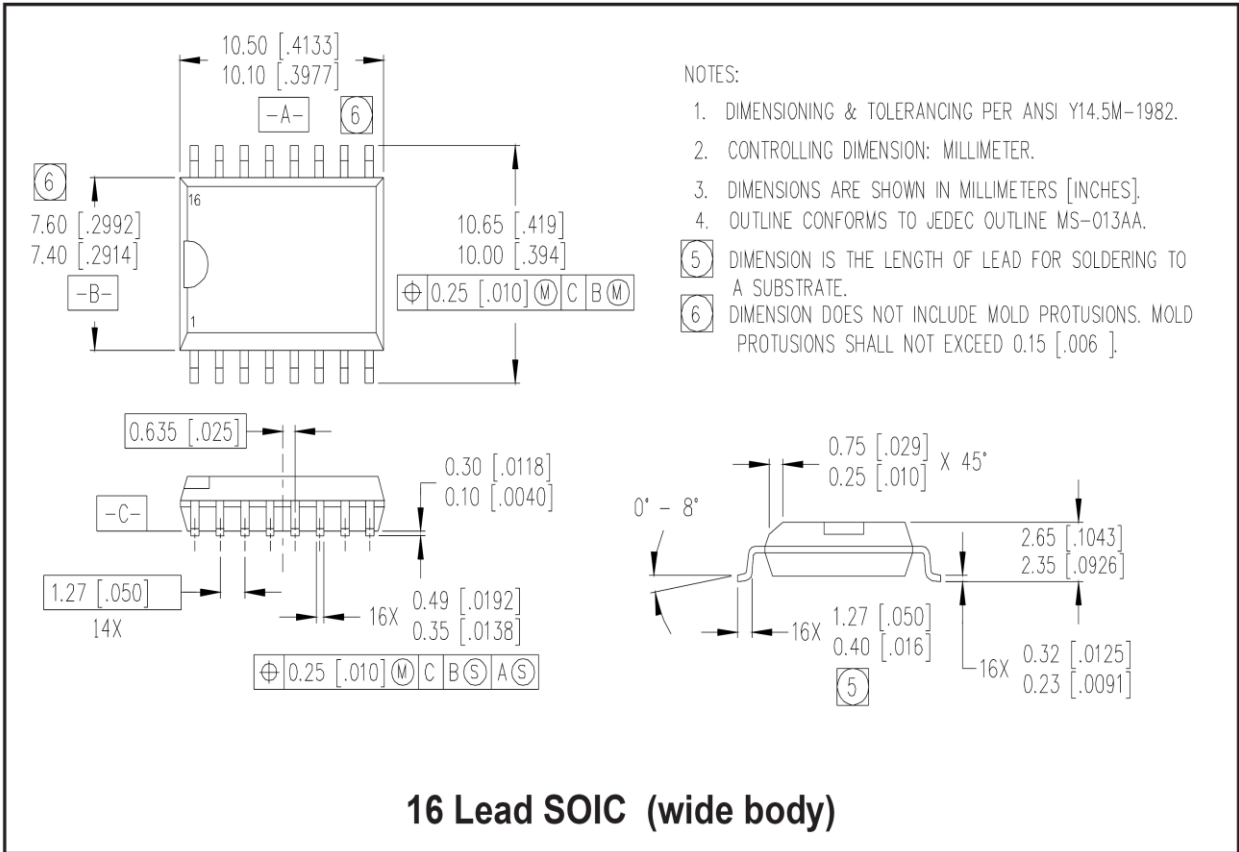
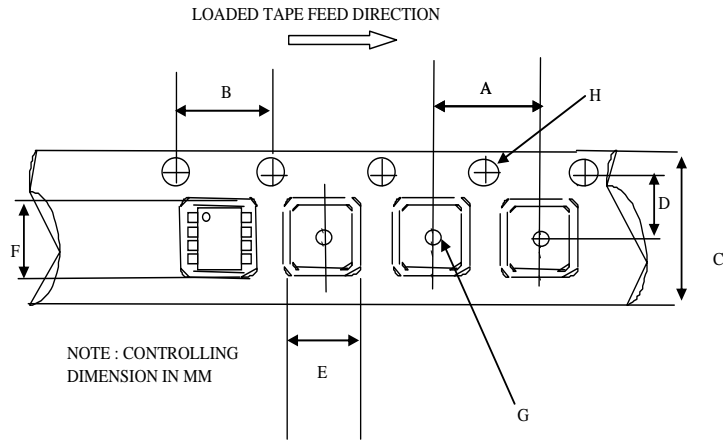

Figure 27. Maximum V_{SS} Positive Offset vs. V_{CC} Supply Voltage

Package Details



Tape and Reel Details



CARRIER TAPE DIMENSION FOR 16SOICN

Code	Metric		Imperial	
	Min	Max	Min	Max
A	7.90	8.10	0.311	0.318
B	3.90	4.10	0.153	0.161
C	15.70	16.30	0.618	0.641
D	7.40	7.60	0.291	0.299
E	6.40	6.60	0.252	0.260
F	10.20	10.40	0.402	0.409
G	1.50	n/a	0.059	n/a
H	1.50	1.60	0.059	0.062

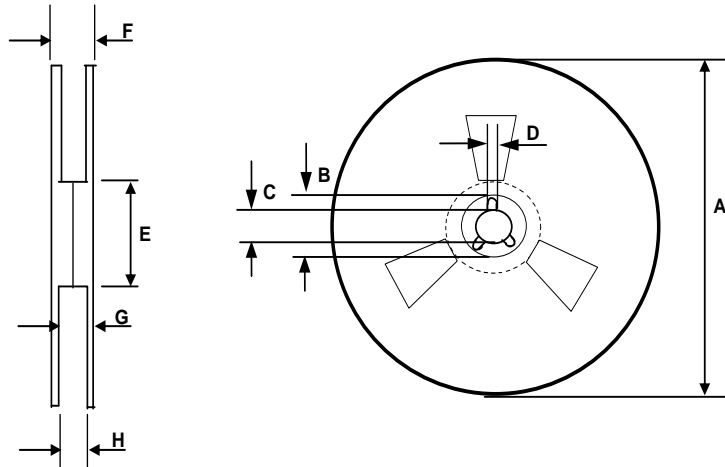

REEL DIMENSIONS FOR 16SOICN

Code	Metric		Imperial	
	Min	Max	Min	Max
A	329.60	330.25	12.976	13.001
B	20.95	21.45	0.824	0.844
C	12.80	13.20	0.503	0.519
D	1.95	2.45	0.767	0.096
E	98.00	102.00	3.858	4.015
F	n/a	22.40	n/a	0.881
G	18.50	21.10	0.728	0.830
H	16.40	18.40	0.645	0.724

Part Marking Information

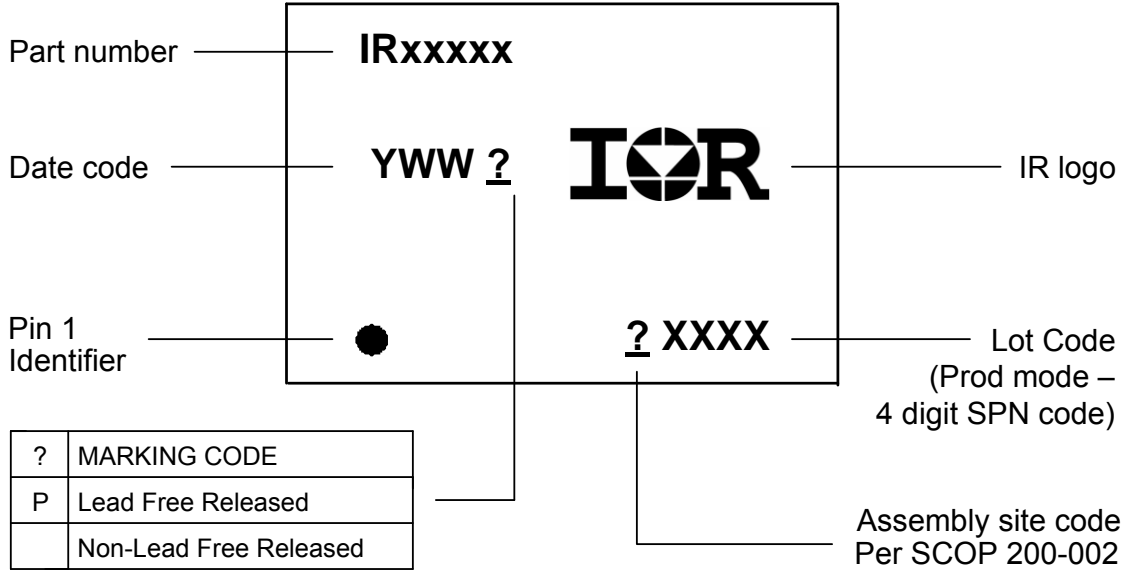

Qualification Information[†]

Qualification Level	Industrial ^{††} (per JEDEC JESD 47)
	Comments: This family of ICs has passed JEDEC's Industrial qualification. IR's Consumer qualification level is granted by extension of the higher Industrial level.
Moisture Sensitivity Level	MSL3 ^{†††} (per IPC/JEDEC J-STD-020)
RoHS Compliant	Yes

† Qualification standards can be found at International Rectifier's web site <http://www.irf.com/>

†† Higher qualification ratings may be available should the user have such requirements. Please contact your International Rectifier sales representative for further information.

††† Higher MSL ratings may be available for the specific package types listed here. Please contact your International Rectifier sales representative for further information.

The information provided in this document is believed to be accurate and reliable. However, International Rectifier assumes no responsibility for the consequences of the use of this information. International Rectifier assumes no responsibility for any infringement of patents or of other rights of third parties which may result from the use of this information. No license is granted by implication or otherwise under any patent or patent rights of International Rectifier. The specifications mentioned in this document are subject to change without notice. This document supersedes and replaces all information previously supplied.

For technical support, please contact IR's Technical Assistance Center
<http://www.irf.com/technical-info/>

WORLD HEADQUARTERS:
 233 Kansas St., El Segundo, California 90245
 Tel: (310) 252-7105

单击下面可查看定价，库存，交付和生命周期等信息

[>>Infineon Technologies\(英飞凌\)](#)