

General information

IGBT Stack for typical voltages of up to 500 V_{RMS}
Rated output current 300 A_{RMS}

- High power converter
- Solar power
- Motor drives

- 62mm power module

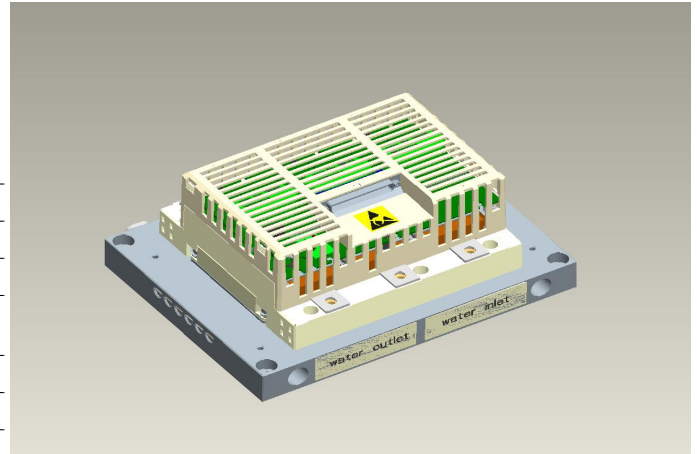

Topology	B6I
Application	Inverter
Load type	Resistive, inductive
Semiconductor (Inverter Section)	3x FF450R12KE4
Heatsink	Water cooled
Implemented sensors	Current, voltage, temperature
Driver signals IGBT	Electrical
Design standards	UL 94, prepared for UL 508C
Sales - name	6PS04512E43W39693
SP - No.	SP001129256

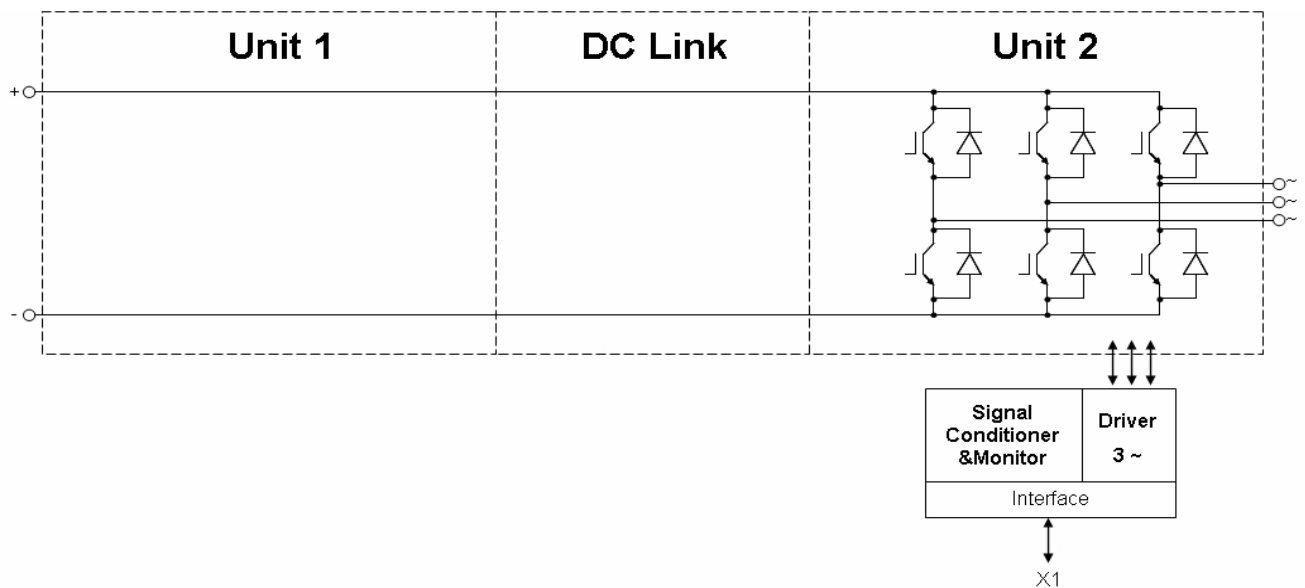

prepared by: OW	date of publication: 2013-08-05
approved by: AR	revision: 2.0



Preliminary data

Characteristic values

DC Link

			min.	typ.	max.	
Rated voltage		V _{DC}		650		V

Notes

The voltage sensor VM110 is only used for measurement. It is realized no over-voltage shutdown.

Inverter Section

			min.	typ.	max.	
Rated continuous current	V _{DC} = 800 V, V _{AC} = 500 V _{RMS} , cos(φ) = 0.85, f _{AC sine} = 5 Hz, f _{sw} = 2500 Hz, T _{inlet} = 40 °C, T _j ≤ 125 °C	I _{AC}			300	A _{RMS}
Continuous current at low frequency	V _{DC} = 800 V, V _{AC} = 500 V _{RMS} , f _{AC sine} = 0 Hz, f _{sw} = 2500 Hz, T _{inlet} = 40 °C, T _j ≤ 125 °C	I _{AC low}			220	A _{RMS}
Rated continuous current for 150% overload capability	I _{AC 150%} = 330 A _{RMS} , t _{on over} = 60 s, t _{recovery} = 600 s, T _j ≤ 125 °C	I _{AC over1}			220	A _{RMS}
Over current shutdown	within 15 μs	I _{AC OC}		625		A _{peak}
Power losses	I _{AC} = 500 A, V _{DC} = 800 V, cos(φ) = 0.85, f _{AC sine} = 5 Hz, f _{sw} = 2500 Hz, T _{inlet} = 40 °C, T _j ≤ 125 °C	P _{loss}		2400		W

Controller interface

Driver and interface board	ref. to separate Application Note		DR210			
			min.	typ.	max.	
Auxiliary voltage		V _{aux}	18	24	30	V
Auxiliary power requirement	V _{aux} = 24 V	P _{aux}			40	W
Digital input level	resistor to GND 10 kΩ, capacitor to GND 1 nF, logic high = on	V _{in low}	0		1.5	V
		V _{in high}	11		15	V
Digital output level	open collector, logic low = no fault, max. 15 mA	V _{out low}	0		1.5	V
		V _{out high}		15		V
Analog current sensor output inverter section	load max 5 mA, @ 300 A _{RMS}	V _{IU ana2} V _{IV ana2} V _{IW ana2}	4.7	4.9	5	V
Analog DC link voltage sensor output	load max 5 mA, @ 900 V	V _{DC ana}	6.4	6.5	6.6	V
Analog temperature sensor output unit 1 (NTC)	load max 5 mA, corresponds to T _j = 125 °C at rated conditions	V _{Theta NTC1}		4.9		V
Analog temperature sensor output inverter section (NTC)	load max 5 mA, @ T _{NTC} = 82 °C	V _{Theta NTC2}		10		V

Notes

Over temperature shut down must be realized by customer.

prepared by: OW	date of publication: 2013-08-05
approved by: AR	revision: 2.0

Technical Information

PrimeSTACK™

6PS04512E43W39693



Preliminary data

System data

				min.	typ.	max.	
EMC robustness	according to IEC 61800-3 at named interfaces	power	V_{Burst}	2			kV
		control	V_{Burst}	1			kV
		aux (24V)	V_{surge}	1			kV
Storage temperature		T_{stor}	-40		85	°C	
Operational ambient temperature	PCB, DC link capacitor, bus bar, excluding cooling medium	$T_{op\ amb}$	-25		55	°C	
Cooling air velocity	PCB, DC link capacitor, bus bar, standard atmosphere	V_{air}	0.3			m/s	
Humidity	no condensation	Rel. F	5		85	%	
Vibration	according to IEC60721				5	m/s ²	
Shock	according to IEC60721				40	m/s ²	
Protection degree			IP00				
Pollution degree			2				
Dimensions	width x depth x height		215	280	120	mm	
Weight			7.7			kg	

Heatsink water cooled

				min.	typ.	max.	
Water flow	according to coolant specification from Infineon	$\Delta V/\Delta t$	10				dm ³ /min
Water pressure					8		bar
Water pressure drop		Δp		50			mbar
Coolant inlet temperature		T_{inlet}	-40		40		°C

Overview of optional components

	Unit 1	Inverter Section	Unit 3
Parallel interface board			
Optical interface board			
Voltage sensor		x	
Current sensor		x	
Temperature sensor		x	
Temperature simulation			
DC link capacitors			
Collector-emitter Active Clamping			

Notes

Setting of Active Clamping TVS-Diodes: $V_z = 824\text{ V}$

prepared by: OW	date of publication: 2013-08-05
approved by: AR	revision: 2.0



Preliminary data

fo - derating curve IGBT (motor), Diode (generator)
 cos(phi) = ±0,85
 T_{cool medium} = 40°C

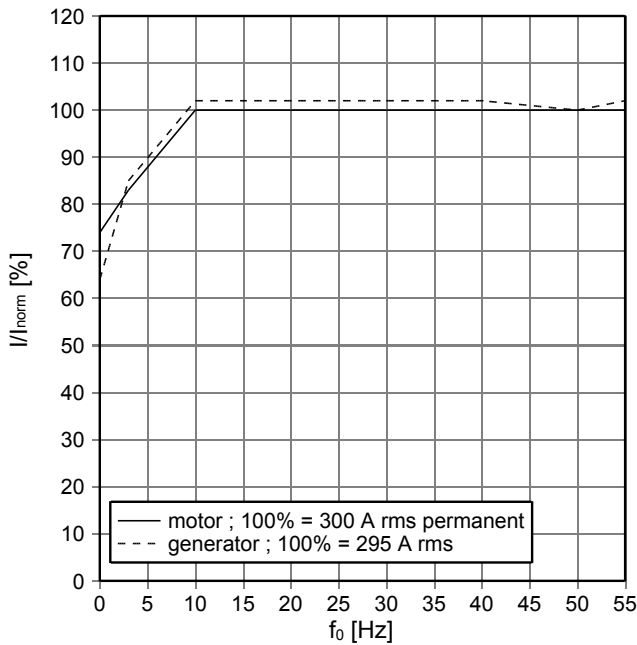

fsw - derating curve IGBT (motor), Diode (generator)
 cos(phi) = ±0,85
 T_{cool medium} = 40°C

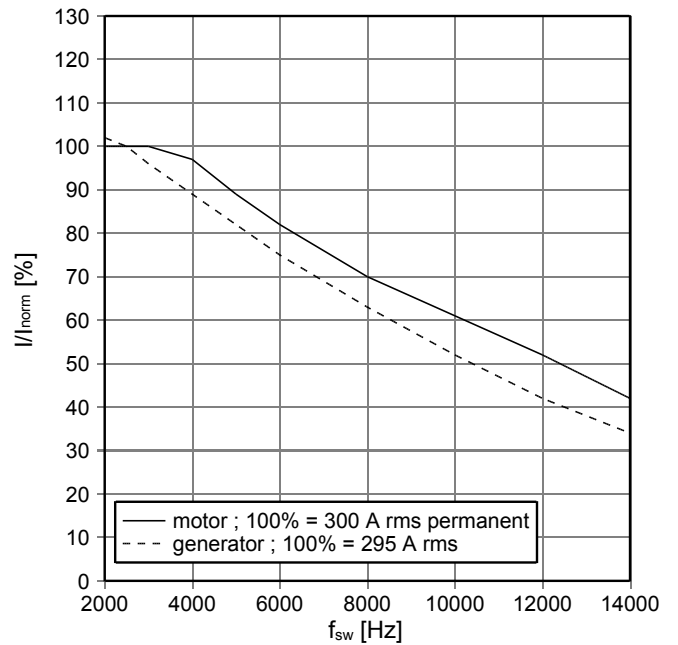

Zth heat sink to ambient per switch
 T_{cool medium} = 40°C

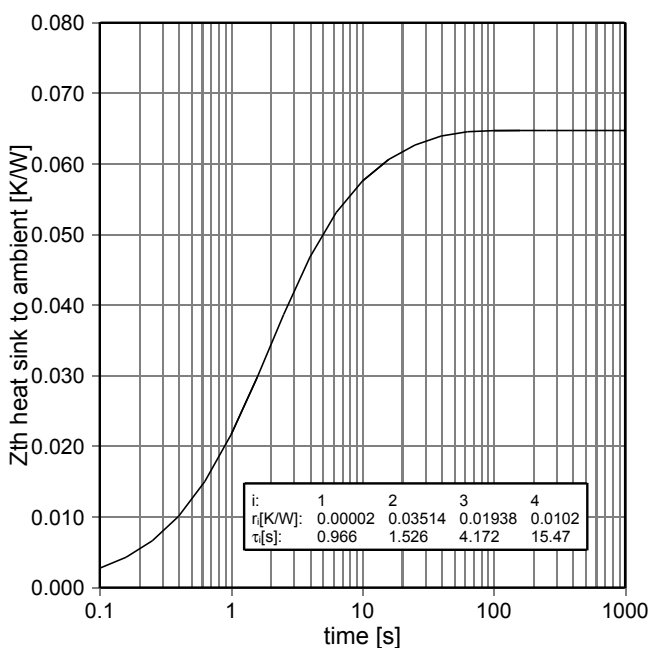

prepared by: OW	date of publication: 2013-08-05
approved by: AR	revision: 2.0

Mechanical drawing

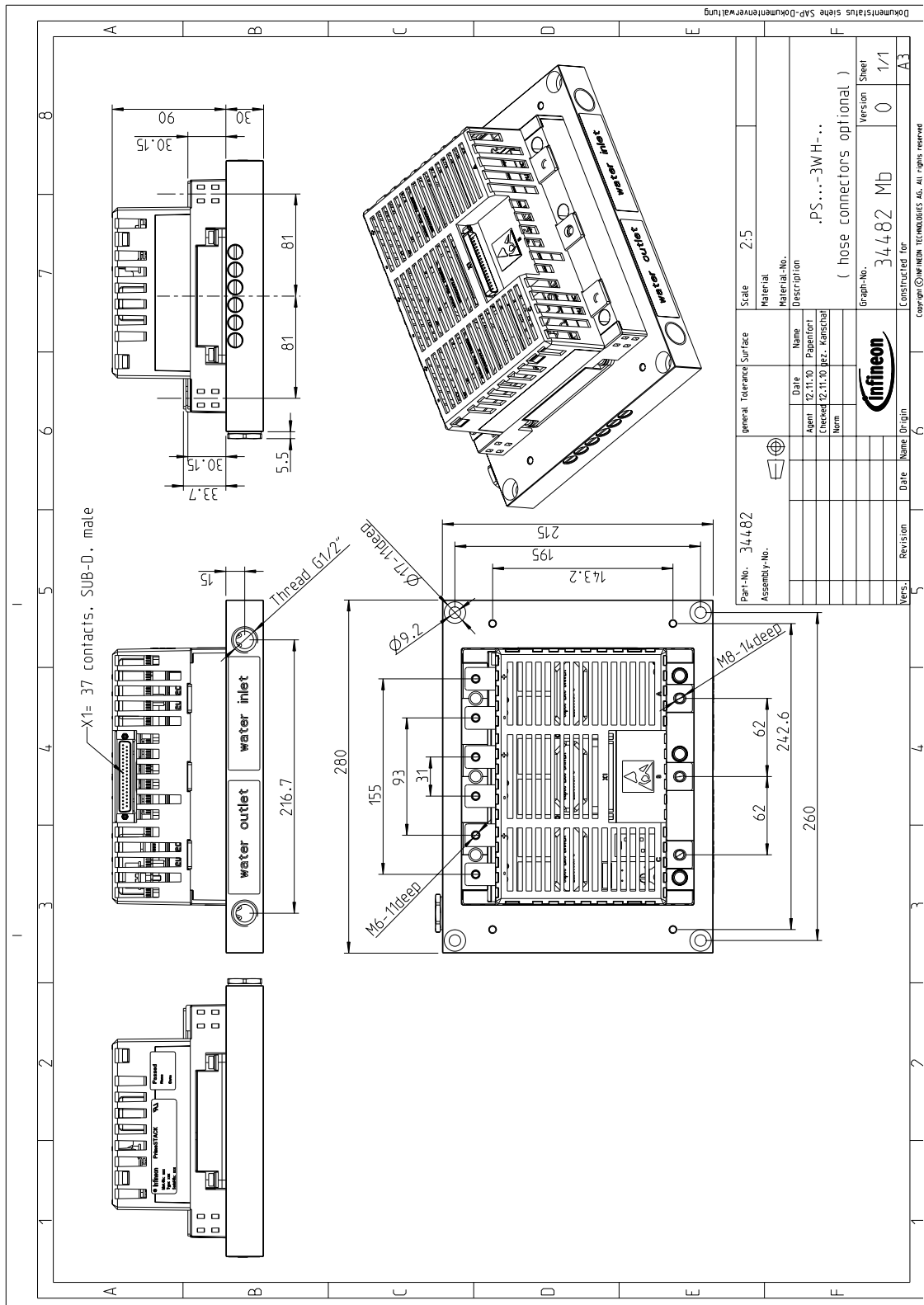

prepared by: OW	date of publication: 2013-08-05
approved by: AR	revision: 2.0

Circuit diagram

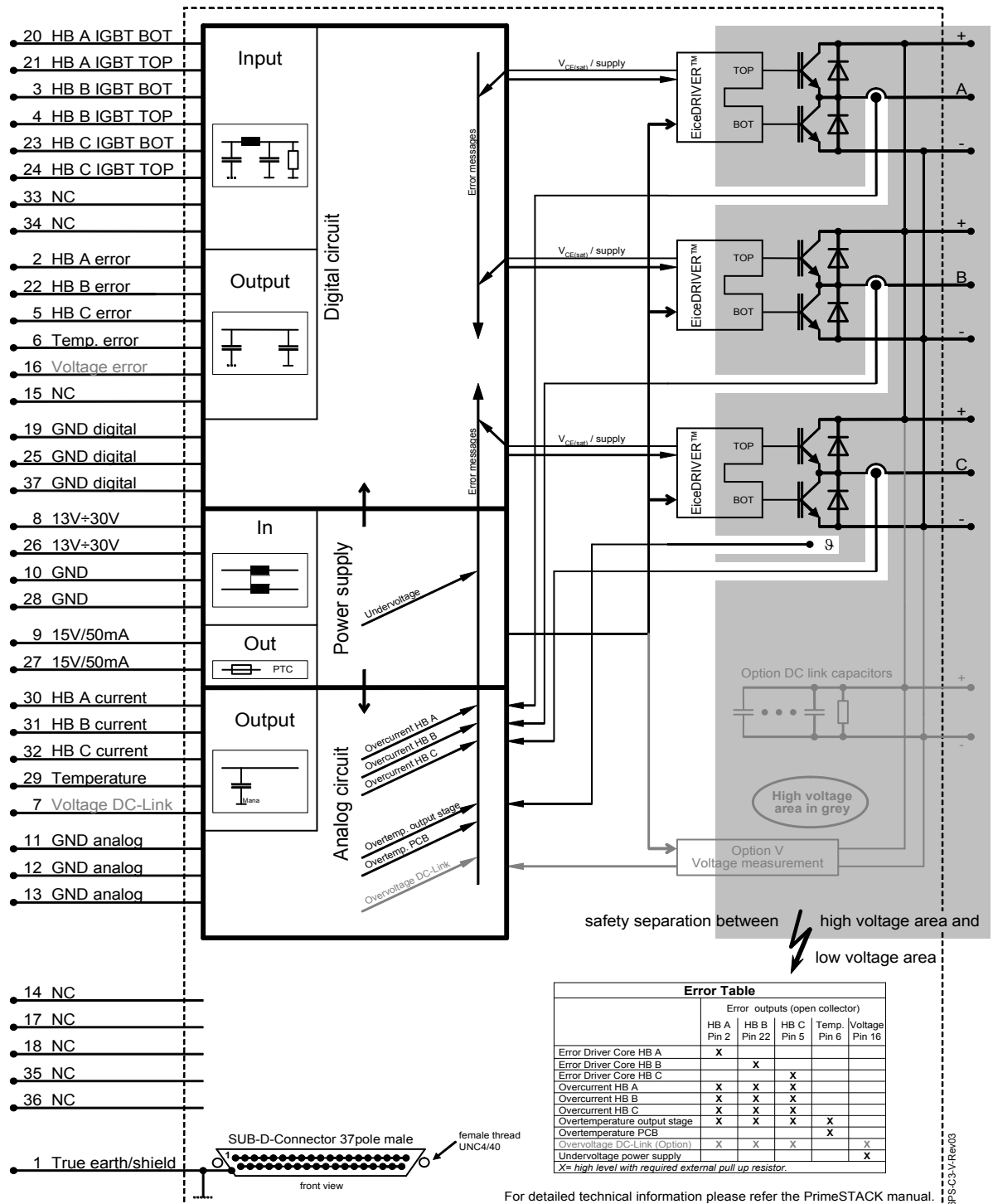

Error Table

	Error outputs (open collector)				
	HB A Pin 2	HB B Pin 22	HB C Pin 5	Temp. Pin 6	Voltage Pin 16
Error Driver Core HB A	X				
Error Driver Core HB B		X			
Error Driver Core HB C			X		
Overcurrent HB A	X	X	X		
Overcurrent HB B	X	X	X		
Overcurrent HB C	X	X	X		
Overtemperature output stage	X	X	X	X	
Overtemperature PCB				X	
Overvoltage DC-Link (Option)	X	X	X		X
Undervoltage power supply					X

X = high level with required external pull up resistor.

For detailed technical information please refer the PrimeSTACK manual.

prepared by: OW date of publication: 2013-08-05
 approved by: AR revision: 2.0



Terms & Conditions of usage

The data contained in this product data sheet is exclusively intended for technically trained staff. You and your technical departments will have to evaluate the suitability of the product for the intended application and the completeness of the product data with respect to such application.

This product data sheet is describing the characteristics of this product for which a warranty is granted. Any such warranty is granted exclusively pursuant the terms and conditions of the supply agreement. There will be no guarantee of any kind for the product and its characteristics.

Should you require product information in excess of the data given in this product data sheet or which concerns the specific application of our product, please contact the sales office, which is responsible for you (see www.infineon.com, sales&contact). For those that are specifically interested we may provide application notes.

Due to technical requirements our product may contain dangerous substances. For information on the types in question please contact the sales office, which is responsible for you.

Should you intend to use the Product in aviation applications, in health or live endangering or life support applications, please notify. Please note, that for any such applications we urgently recommend

- to perform joint Risk and Quality Assessments;
- the conclusion of Quality Agreements;
- to establish joint measures of an ongoing product survey, and that we may make delivery depended on the realization of any such measures.

If and to the extent necessary, please forward equivalent notices to your customers.

Changes of this product data sheet are reserved.

Safety Instructions

Prior to installation and operation, all safety notices and warnings and all warning signs attached to the equipment have to be carefully read. Make sure that all warning signs remain in a legible condition and that missing or damaged signs are replaced. To installation and operation, all safety notices and warnings and all warning signs attached to the equipment have to be carefully read. Make sure that all warning signs remain in a legible condition and that missing or damaged signs are replaced.

prepared by: OW	date of publication: 2013-08-05
approved by: AR	revision: 2.0

单击下面可查看定价，库存，交付和生命周期等信息

[>>Infineon Technologies\(英飞凌\)](#)